

# 20 21



**Catalogo Generale**  
**Master Catalogue**  
**Gesamtkatalog**  
**Catalogue Général**

**Panaria**  
ceramica

## **La bellezza di sentirsi a casa**

The beauty of feeling at home

Das schöne Gefühl, sich zu Hause zu fühlen

La beauté de se sentir chez soi

# Indice generale

List of contents\_Inhalt\_Index général

## I nostri valori 6

Our values\_Unsere Werte\_Nos valeurs

## Le nostre eccellenze 14

Our excellences\_Unsere Exzellenz\_  
Nos excellences

Protect	16
Zero.3	18
20 mm	22
Soluzioni Decorative	24
Linea Fiorido	26

## Il nostro Gruppo 28

Our Group\_Unsere Unternehmensgruppe\_  
Notre Groupe

## Le collezioni 36

Collections\_Kollektionen\_Collections

Assi d'Alpe	284
Bioarch	44
Borealis	292
Context	166
Cross Wood	306
Discover	56
Eternity	248
Even	348
Experience	180
Frame	68
Genesis	188
Glam	362
Horizon	80
Memory Mood	194
Motion	208
Must	380
North Cape	316
Nuance	322
Opificio 22/a	216
Petra Solis	92
Pierre des Rêves	102
Pietre di Fanes	116
Prime Stone	122
Rock Style	136
Stone Trace	144
Tracks	156
Trilogy	266
Urbanature	230
Wallcraft	390
Wood Relive	336

## Dati tecnici 404

Technical data\_Technische Daten\_  
Données techniques

Caratteristiche tecniche <i>Technical features_Technische Eigenschaften_ Caractéristiques techniques</i>	406
Informazioni per la posa <i>Laying information_Informationen für die Verlegung_Informations pour la pose</i>	414
Resistenza allo scivolamento <i>Slip resistance_Rutschfestigkeit_ Résistance au glissement</i>	417
Tabelle calibri <i>Size table_Formattabellen_ Tableaux des calibres</i>	418
Pulizia <i>Cleaning_Reinigung_Nettoyage</i>	420
Panaria e l'ambiente <i>Panaria and the environment_Panaria und die Umwelt_Panaria et l'environnement</i>	426
Certificazioni di sistema <i>Management system certifications_ Qualitätssystem Zertifizierungen_ Certifications du système de production</i>	430
Certificazioni di prodotto <i>Product certification_Produktzertifizierung_ Certifications de produit</i>	432
Prodotti certificati <i>Certified products_Zertifizierte Erzeugnisse_ Produits certifiés</i>	435
Indice alfabetico dei prodotti <i>List of products in alphabetical order_ Alphabetisches verzeichnis der Produkte_ Index alphabétique des produits</i>	436
Condizioni generali di vendita <i>General conditions of sale_Allgemeine Verkaufsbedingungen_Conditions générales de vente</i>	440

## Indice per effetto

Index by look\_Effekt Zuordnung  
Index par effet

### Effetto Pietra

Stone look_Stein-Optik_Effet pierre		
Bioarch		44
Discover	[P]	56
Frame	●	68
Horizon	[P]	80
Petra Solis		92
Pierre des Rêves	[P]	102
Pietre di Fanes		116
Prime Stone	[P]	122
Rock Style	●	136
Stone Trace	[P]	144
Tracks	●	156

### Effetto Cemento

Concrete look_Zement-Optik_Effet ciment		
Context	[P]	166
Experience		180
Genesis	●	188
Memory Mood		194
Motion	●	208
Opificio 22/a	[P]	216
Urbanature	[P]	230

### Effetto Marmo

Marble look_Marmor-Optik_Effet marbre		
Eternity	[P]	248
Trilogy	[P]	266

### Effetto Legno

Wood look_Holz-Optik_Effet bois		
Assi d'Alpe		284
Borealis	[P]	292
Cross Wood		306
North Cape	[P]	316
Nuance	[P]	322
Wood Relive	●	336

### Effetto Cromatico

Chromatic look_Chromatischer Effekt_Effet chromatique		
Even		348
Glam		362
Must	[P]	380
Wallcraft		390

● = **Fiordo**

[P] = **P R ( ) T E C T**  
ANTIBATTERICO · ANTIMICROBIAL

## Indice per tecnologia

Index by technology\_Technologie  
Zuordnung\_Index par technologie

### Zero.3

Gres porcellanato laminato_Laminated porcelain stoneware_Laminiertes Feinsteinzeug_Grès cérame laminé		
Context	[P]	166
Eternity	[P]	248
Experience		180
Glam		362
Must	[P]	380
Prime Stone	[P]	122
Stone Trace	[P]	144
Trilogy	[P]	266
Urbanature		230

### Gres Porcellanato

Porcelain stoneware_Feinsteinzeug_Grès cérame		
Assi d'Alpe		284
Bioarch		44
Borealis	[P]	292
Context	[P]	166
Cross Wood		306
Discover	[P]	56
Eternity	[P]	248
Frame	●	68
Genesis	●	188
Horizon	[P]	80
Memory Mood		194
Motion	●	208
North Cape	[P]	316
Nuance	[P]	322
Opificio 22/a	[P]	216
Petra Solis		92
Pierre des Rêves	[P]	102
Pietre di Fanes		116
Prime Stone	[P]	122
Rock Style	●	136
Tracks	●	156
Trilogy	[P]	266
Urbanature	[P]	230
Wood Relive	●	336

### 20 mm

Alto spessore_High thickness_20 mm Stärke_Forte épaisseur		
Bioarch		44
Borealis		292
Context		166
Cross Wood		306
Discover		56
Frame	●	68
Horizon		80
Memory Mood		194
Nuance		322
Opificio 22/a		216
Petra Solis		92
Pierre des Rêves		102
Prime Stone		122
Tracks	●	156
Urbanature		230

### Monoporosa

Single-fired wall tiles_Weißschärbige wandfliese_Faïence		
Even		348
Trilogy		266
Wallcraft		390

## Indice per formati

Index by sizes\_Index nach Formaten\_Index par formats

### 100x300

Experience	180
Must	380
Prime Stone	122
Trilogy	266
Urbanature	230

### 120x278

Stone Trace	144
-------------	-----

### 120x260

Context	166
Eternity	248

### 100x250

Prime Stone	122
-------------	-----

### 120x120

Context	166
Eternity	248
Stone Trace	144

### 100x100

Experience	180
Must	380
Prime Stone	122
Trilogy	266
Urbanature	230

### 50x100

Experience	180
Glam	362
Prime Stone	122
Trilogy	266
Urbanature	230

### 35x100

Even	348
Trilogy	266
Wallcraft	390

### 30x180

Borealis	292
North Cape	316
Nuance	322

### 20x180

Borealis	292
North Cape	316
Nuance	322

### 60x120

Context	166
Discover	56
Eternity	248
Horizon	80
Pierre des Rêves	102
Stone Trace	144
Trilogy	266

### 40x120

Borealis	292
Nuance	322

### 30x120

Nuance	322
Cross Wood	306

### 20x120

Borealis	292
Cross Wood	306
Nuance	322
Wood Relive	336

### 20x90,5

Assi d'Alpe	284
North Cape	316

### 90x90

Context	166
Horizon	80
Memory Mood	194
Opificio 22/a	216
Pierre des Rêves	102
Prime Stone	122
Trilogy	266
Urbanature	230

### 45x90

Frame	68
Prime Stone	122
Urbanature	230

### 22,5x90

Urbanature	230
------------	-----

### 60x60

Bioarch	44
Context	166
Discover	56
Eternity	248
Frame	68
Genesis	188
Horizon	80
Memory Mood	194
Motion	208
Opificio 22/a	216
Petra Solis	92
Pierre des Rêves	102
Prime Stone	122
Tracks	156
Trilogy	266
Urbanature	230

### 40x60

Petra Solis	92
-------------	----

### 30x60

Bioarch	44
Context	166
Discover	56
Eternity	248
Frame	68
Genesis	188
Horizon	80
Memory Mood	194
Motion	208
Opificio 22/a	216
Pierre des Rêves	102
Prime Stone	122
Tracks	156
Trilogy	266
Urbanature	230

### 30x56,5

Rock Style	136
------------	-----

### 20x60

Discover	56
Prime Stone	122

### 15x60

Bioarch	44
Discover	56
Prime Stone	122

### 50x50

Experience	180
------------	-----

### 20x40

Bioarch	44
Petra Solis	92
Pierre des Rêves	102
Pietre di Fanes	116

### 40x40

Petra Solis	92
-------------	----

### 20x30,2

Pierre des Rêves	102
------------------	-----

### 20x30,5

Bioarch	44
Pietre di Fanes	116

### 20x20

Bioarch	44
Memory Mood	194
Opificio 22/a	216
Petra Solis	92
Pierre des Rêves	102
Pietre di Fanes	116



Da sempre sappiamo scegliere il meglio per la casa. *“La bellezza di sentirsi a casa”* per noi significa il piacere di vivere in spazi armonici e versatili, in cui le nostre collezioni soddisfano personalità molteplici e desideri differenti adattandosi ad usi e costumi in divenire. Nel corso del tempo abbiamo saputo e voluto evolverci per essere sempre più vicini a tante storie di casa, di progetti e di persone, con la consapevolezza della nostra tradizione che sostiene con rinnovata energia la visione di un futuro migliore.

We have always managed to choose the best for the home. To us, *“the beauty of feeling at home”* means the pleasure of living in harmonious and versatile spaces in which our collections satisfy multiple personalities and different desires, adapting to changing habits and customs. Over time, we have been able and willing to evolve to play an increasingly key role in stories of homes, design and people, with the awareness of our tradition that supports the vision of a better future with renewed energy.

Wir verstehen es seit jeher, das Beste für zu Hause auszuwählen. *„Die Schönheit, sich wie zu Hause zu fühlen“* bedeutet für uns das Vergnügen, in harmonischen und vielseitigen Räumen zu leben, in denen unsere Kollektionen vielfältigen Persönlichkeiten und unterschiedlichen Wünschen gerecht werden und sich an wandelnde Nutzungen und Gebräuche anpassen. Im Laufe der Zeit konnten und wollten wir uns weiterentwickeln, um unzähligen Geschichten von Zuhause, Projekten und Menschen immer noch näher zu sein, mit dem Bewusstsein für unsere Tradition, die mit erneuerter Energie die Vision einer besseren Zukunft unterstützt.

Nous savons depuis toujours choisir le meilleur pour la maison. *« La beauté de se sentir chez soi »* signifie pour nous le plaisir de vivre dans des espaces harmonieux et polyvalents, dans lesquels nos collections satisfont de multiples personnalités et différents désirs en s'adaptant à des usages et coutumes en pleine évolution. Au fil du temps nous avons su et voulu évoluer afin d'être toujours plus proche de tant d'histoires de maison, de projets et de personnes, en ayant conscience que notre tradition supporte la vision d'un avenir meilleur avec une énergie renouvelée.

# Benvenuto nel mondo Panaria

Welcome to the world of Panaria\_Willkommen in der Welt von Panaria\_Bienvenue dans le monde de Panaria



Le nostre origini partono dal 1974, da una terra che ha sempre saputo combinare lavoro e cultura ceramica, che ha saputo coinvolgere le persone coltivando il talento e la ricerca della qualità. Chi ha creato Panaria Ceramica ancora la porta avanti, con immutata energia ed entusiasmo, con la continuità nelle relazioni con i clienti ed il territorio, con una solidità e una credibilità che non sono mai venute meno.

The company dates back to 1974, to a land that has always known how to combine work and ceramic culture, while involving people by cultivating talent and the pursuit of quality. Those who created Panaria Ceramica are still driving it forward with the same energy and enthusiasm, with continuous relationships with customers and the local area, and with a consistently sound and credible approach.

Unsere Wurzeln reichen bis ins Jahr 1974 zurück, in eine Gegend, die es seit jeher verstanden hat, Arbeit und die Kultur der Keramik miteinander zu verbinden, die in der Lage war, Menschen durch Förderung von Talenten und Suche nach Qualität einzubeziehen. Die Gründer von Panaria Ceramica bringen das Unternehmen nach wie vor mit unveränderter Energie und Begeisterung, mit der Kontinuität in den Beziehungen zu den Kunden und der Region, sowie mit einer Solidität und Glaubwürdigkeit voran, die nie nachgelassen haben.

Nos origines remontent à 1974, dans une contrée qui a toujours su combiner travail et culture de la céramique, qui a su impliquer les personnes en cultivant le talent et la recherche de la qualité. Les fondateurs de Panaria Ceramica continuent à la développer, avec une énergie et un enthousiasme inchangés, en cultivant les relations avec les clients et le territoire, avec une solidité et une crédibilité qui n'ont jamais faibli.

# Una storia che viene da lontano

A long story\_Eine Geschichte mit fernen Ursprüngen\_ Une histoire qui vient de loin



Essere protagonisti dello scenario ceramico da quasi 50 anni significa aver portato sul mercato creazioni di successo, prodotti memorabili, soluzioni sempre pensate per realizzare la casa dei sogni. Un percorso condiviso con tutti voi, una lunga tradizione che quotidianamente si rinnova, pensando sempre alla soddisfazione dei nostri clienti.

Being a leading player in the ceramic tile industry for almost 50 years means that we have brought successful creations to the market, memorable products and solutions that are always designed to create the home of your dreams. A journey shared with all of you, a long tradition that is renewed daily, always taking into account our customers' satisfaction.

Seit fast 50 Jahren Protagonist in der Keramikszene zu sein, bedeutet, erfolgreiche Kreationen, unvergessliche Produkte und Lösungen auf den Markt gebracht zu haben, die für das Haus der Träume gedacht sind. Ein Weg, den wir mit Ihnen allen geteilt haben, eine lange Tradition, die sich jeden Tag erneuert, stets mit dem Gedanken an die Zufriedenheit unserer Kunden.

Être les principaux acteurs sur la scène de la céramique depuis près de 50 ans signifie avoir proposé sur le marché des créations couronnées de succès, des produits mémorables, des solutions toujours pensées pour réaliser la maison de vos rêves. Un parcours partagé avec vous, une longue tradition, qui se renouvelle chaque jour, en nous souciant toujours de satisfaire nos clients.

## Un percorso pieno di prodotti memorabili

A journey full of memorable products. Ein Weg voller unvergesslicher Produkte. Un parcours jalonné de produits mémorables



Come fatta in casa.



Bella. Naturale. Resistente.

Tutti desideriamo uno spazio che ci rappresenti e assomigli, che possa essere specchio di ciò che siamo e di come vogliamo vivere, che significhi sicurezza e che sia teatro e palcoscenico di esperienze quotidiane e di emozioni da condividere. Panaria ha saputo rinnovare nel tempo i valori di una grande cultura ceramica, uniti alla passione e ad alla capacità spiccatamente made in Italy di proporre soluzioni di eccellenza estetica, qualità e affidabilità, per creare ogni giorno un nuovo modo di vivere la casa, per accompagnare tante storie diverse in cui sentirsi protagonisti.

We all want a space that represents and resembles us, which can be a mirror of what we are and of how we want to live, which represents safety and provides a stage for sharing everyday experiences and emotions. Over the years, Panaria has managed to renew the values of a great ceramic culture, combined with passion and a distinctly Made in Italy ability to offer solutions that boast outstanding aesthetic appeal, quality and reliability, creating a new way of experiencing the home every day and accompanying many different stories in which to play a starring role.

Wir alle wünschen uns einen Raum, der uns repräsentiert und uns ähnlich ist, der ein Spiegel dessen sein kann, was wir sind und wie wir leben wollen, der Sicherheit bedeutet und der Schauplatz und Bühne von alltäglichen Erfahrungen und gemeinsamen Emotionen ist. Panaria hat es im Laufe der Zeit verstanden, die Werte einer großen Keramikultur zu erneuern, zusammen mit der Leidenschaft und der ausgeprägten Made in Italy-Fähigkeit, Lösungen mit hervorragender Ästhetik, Qualität und Zuverlässigkeit bereitzustellen, um jeden Tag ein neues Wohngefühl zu erzeugen und zahlreiche unterschiedliche Geschichten zu begleiten, in denen man sich als Protagonisten fühlen kann.

Nous aspirons tous à un espace qui nous représente et nous ressemble, qui puisse refléter ce que nous sommes et la façon dont nous voulons vivre, qui soit à la fois un lieu sûr et le théâtre et la scène d'expériences quotidiennes et d'émotions à partager. Panaria a su renouveler au fil du temps les valeurs d'une grande culture de la céramique, alliées à la passion et à la capacité du Made in Italy d'offrir des solutions d'excellence esthétique, de qualité et de fiabilité, pour créer chaque jour une nouvelle façon de vivre la maison, pour accompagner d'innombrables histoires différentes en y jouant le rôle principal.

## Anche la tua casa è una storia da raccontare

Your home is also a story to tell\_Auch Ihr Zuhause hat eine Geschichte zu erzählen\_Votre maison aussi est une histoire à raconter





# Le nostre eccellenze



Our excellences\_ Unsere Exzellenz\_ Nos excellences



P R ( ) T E C T ®

## Protezione antibatterica

Antibacterial protection\_Antibakterieller Schutz\_  
Protection antibactérienne

L'esclusiva tecnologia Panariagroup per pavimenti e rivestimenti antibatterici ad altissime performance. Per un abitare sano, sicuro e protetto.

Die exklusive Technologie Panariagroup für antibakterielle und hochleistungsfähige Fußböden und Verkleidungen. Für ein gesundes, sicheres und geschütztes Wohnen.

The exclusive Panariagroup technology for antimicrobial floor and wall coverings with the highest performance. To live healthily, safe and secure.

La technologie exclusive de Panariagroup pour sols et revêtements antibactériens aux performances très élevées. Pour un habitat sain, sûr et protégé.



### AZIONE POTENTE

*elimina i batteri e ne impedisce la proliferazione*

### POWERFUL ACTION

*eliminates microbes and prevents their reproduction*

### LEISTUNGSSTARKE WIRKUNG

*eliminiert Bakterien und verhindert die Vermehrung*

### ACTION PUISSANTE

*élimine les bactéries et empêche leur prolifération*



### EFFICACIA ETERNA

*grazie alla tecnologia integrata in modo permanente nel prodotto*

### ETERNAL EFFECTIVENESS

*thanks to the technology permanently integrated into the product*

### DAUERHAFT WIRKSAMKEIT

*dank der permanent im Produkt integrierten Technologie*

### EFFICACITÉ ÉTERNELLE

*grâce à la technologie intégrée de façon permanente dans le produit*



### PROTEZIONE CONTINUA

*sempre attivo, 24 ore su 24, con e senza luce solare*

### CONTINUOUS PROTECTION

*always active, 24 hours a day, with and without sunlight*

### DAUERSCHUTZ

*rund um die Uhr aktiv, mit oder ohne Sonnenlicht*

### PROTECTION CONTINUE

*toujours actif, 24 heures sur 24, avec et sans lumière du soleil*

con - with - mit - avec

MICROBAN®

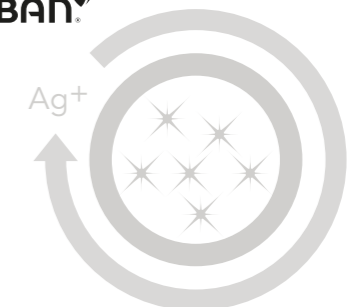

protect.panariagroup.it

PANARIAgroup®

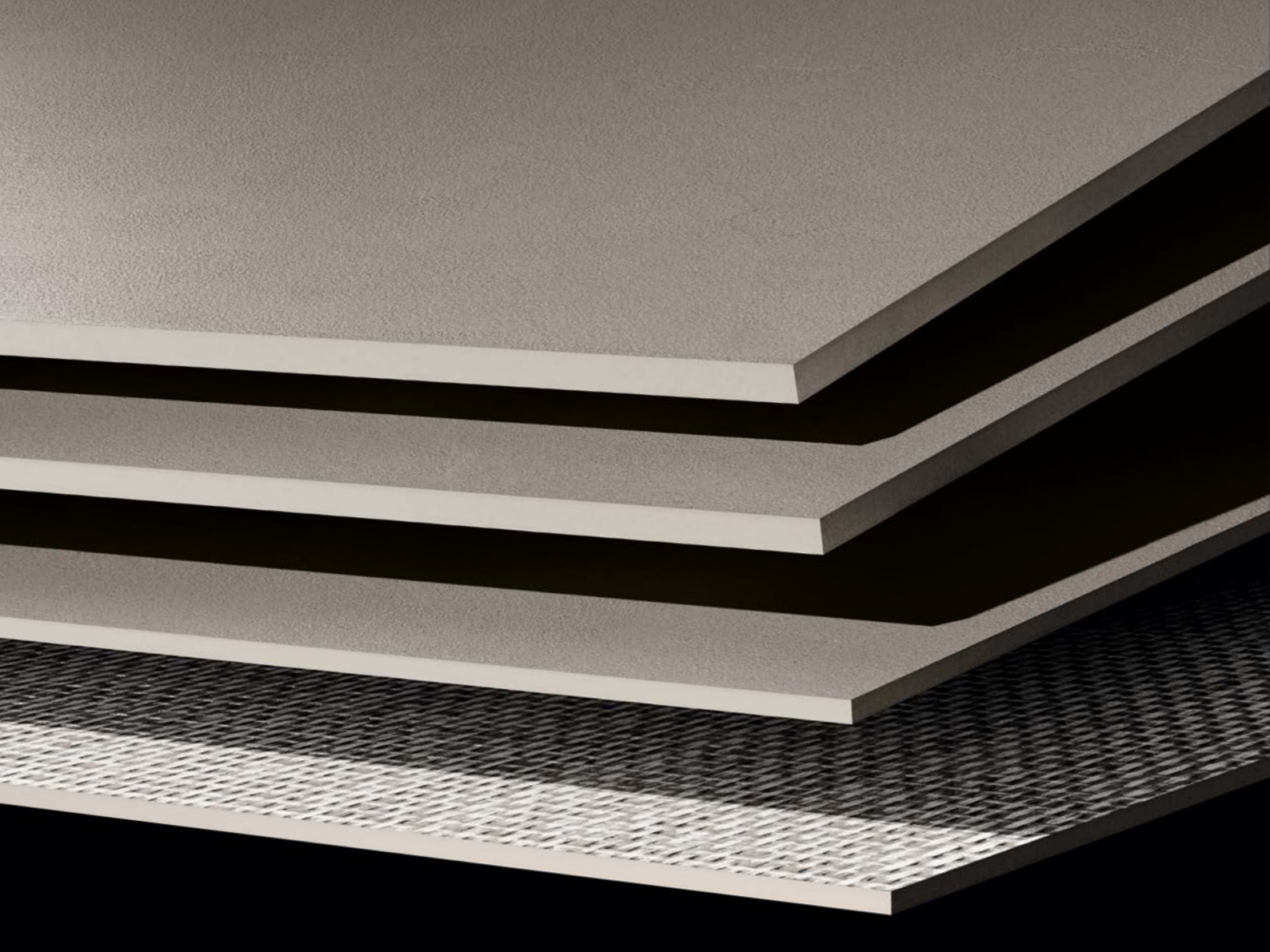

## Zero.3

# Lastre ceramiche sottili di qualità superiore

Superior quality thin ceramic slabs\_Dunne hochwertige Keramikplatten\_Dalles céramiques fines de qualité supérieure

Gres porcellanato laminato in grande formato: un materiale leggero, versatile e resistente per nuove prospettive progettuali nel mondo dell'architettura e dell'abitare.

Großformatiges laminiertes Feinsteinzeug: ein leichtes, vielseitiges und widerstandsfähiges Material für Design-Perspektiven in der Welt der Architektur und des Wohnens.

Large-sized laminated porcelain stoneware: a light, resistant and versatile product for new design perspectives in the world of architecture and housing.

Grès cérame laminé en grand format : un matériau léger, polyvalent et résistant pour de nouvelles perspectives conceptuelles dans le monde de l'architecture et de l'habitat.

### FORMATI SIZES\_FORMATE\_FORMATS

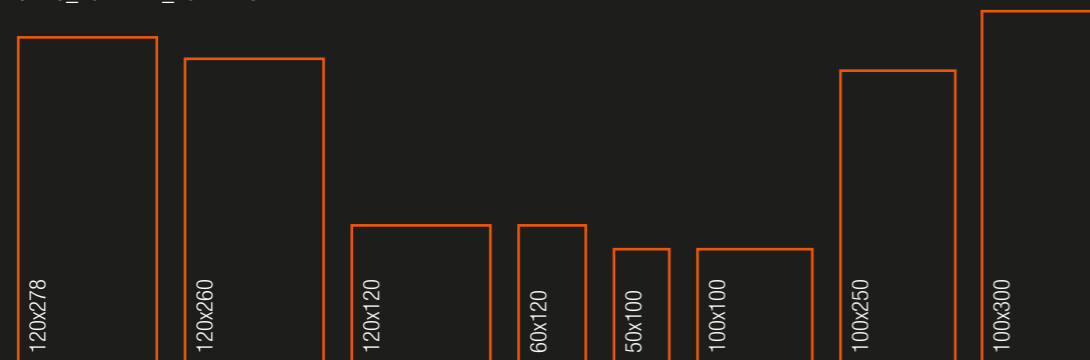

### ZERO.3 + 6 mm

**SOTTILE E RESISTENTE**  
THIN AND RESISTANT  
DÜNN UND WIDERSTANDSFÄHIG  
FIN ET RÉSISTANT

### ZERO.3 PLUS + 3,5 mm - 5,5 mm

**ULTRASOTTILE E ULTRARESISTENTE. CON RINFORZO IN FIBRA DI VETRO**  
ULTRA-THIN AND ULTRA-RESISTANT. WITH FIBREGLASS MESH REINFORCEMENT  
ULTRADÜNN UND ULTRAWIDERSTANDSFÄHIG MIT GLASFASERVERSTÄRKUNG  
ULTRA FIN ET ULTRA RÉSISTANT AVEC RENFORT EN FIBRE DE VERRE

### MASSIMI STANDARD QUALITATIVI E PRESTAZIONALI Grazie all'utilizzo di materie prime pregiate.

**HÖCHSTE QUALITÄTS- UND LEISTUNGSSTANDARDS**  
Dank der Verwendung von hochwertigen Rohstoffen.

### LASTRE SUPERCOMPATTE ED ELASTICHE Grazie a un processo di pressatura unico.

**SUPERKOMPATTE UND ELASTISCHE PLATTEN**  
Dank eines einzigartigen Pressvorgangs.

### ECCELLENTE RESA ESTETICA DEI MATERIALI Grazie a tecniche esclusive di lavorazione delle superfici.

**AUSGEZEICHNETE ÄSTHETIK DER MATERIALIEN**  
Dank der exklusiven Bearbeitungstechniken der Oberflächen.

### STRAORDINARIA EXTRA-RESISTENZA Grazie al rinforzo in fibra di vetro.

**AUSERGEWÖHNLICHE EXTRA-FESTIGKEIT**  
Dank der Verstärkung aus Glasfaser.

### ALTA SOSTENIBILITÀ AMBIENTALE Meno materie prime utilizzate, minor consumo di acqua ed energia, minori emissioni di CO<sub>2</sub>.

**HOHE NACHHALTIGKEIT**  
Geringer Rohstoffverbrauch, weniger Wasser- und Energieverbrauch sowie weniger CO<sub>2</sub>-Emissionen.

### HIGHEST STANDARDS IN QUALITY AND PERFORMANCE Thanks to the use of the best raw materials.

**CRITERES TRÈS ÉLEVÉS DE QUALITÉ ET DE PERFORMANCE**  
Grâce à l'utilisation de matières premières précieuses.

### HIGHLY COMPACT AND ELASTIC SLABS Thanks to a unique pressing process.

**DALLES SUPER COMPACTES ET ÉLASTIQUES**  
Grâce à un processus de pressage unique.

### EXCELLENT AESTHETIC LOOK OF THE PRODUCTS Thanks to exclusive surface processing technologies.

**EXCELLENT RENDU ESTHÉTIQUE DES MATÉRIAUX**  
Grâce à des techniques exclusives de production des surfaces.

### EXTRAORDINARY ADDED RESISTANCE Thanks to the reinforcing fibreglass mesh.

**EXTRAORDINAIRE EXTRA-RESISTANCE**  
Grâce au renfort en fibre de verre.

### HIGHLY ECO-FRIENDLY Less raw materials used, lower water and energy consumption and lower CO<sub>2</sub> emissions.

**HAUTE DURABILITÉ ENVIRONNEMENTALE**  
Moins de matières premières utilisées, moins de consommation d'eau et d'énergie, moins d'émissions de CO<sub>2</sub>.



## Zero.3

# Rinnovare senza demolire

Renovations without demolition\_Renovieren ohne  
demolieren\_Renovier sans démolir

Le lastre ceramiche sottili sono ideali per rinnovare senza demolire. Possono essere posate in sovrapposizione al pavimento esistente con benefici di velocità, comodità, risparmio e assenza di detriti. È così possibile dunque ristrutturare uno spazio in modo altamente sostenibile, considerando, oltre alle caratteristiche del gres porcellanato laminato, anche l'elevato impatto nella generazione complessiva di rifiuti che normalmente hanno gli scarti di natura edilizia.

Thin ceramic slabs are perfect for renovating without demolishing. They can be installed on top of existing floors, providing the benefit of speed, convenience, savings, and absence of debris. Therefore, it is possible to renovate a space in a highly sustainable way, taking into account not only the characteristics of laminated porcelain stoneware, but also the enormous impact which construction debris usually has on the overall creation of waste.

Dünne Keramikplatten sind ideal zum Renovieren ohne Abbrucharbeiten. Sie können über dem vorhandenen Bodenbelag verlegt werden: schnell, einfach, kostengünstig und ohne Bauschutt. Die Renovierung eines Raums ist umso nachhaltiger, wenn neben den Merkmalen des laminierten Feinsteinzeugs an sich auch berücksichtigt wird, welcher großen Anteil Bauschutt normalerweise an der Abfallerzeugung im Ganzen hat.

Les dalles en céramique fine sont parfaites pour rénover sans démolir. Pouvant être superposées au sol existant, elles constituent une solution rapide, pratique et économique, le tout sans le moindre débris. Ainsi, il est possible de rénover un espace de façon très durable, si l'on considère, outre les caractéristiques propres au grès cérame laminé, l'impact considérable qu'a, d'ordinaire, la production totale de déchets provenant du bâtiment.

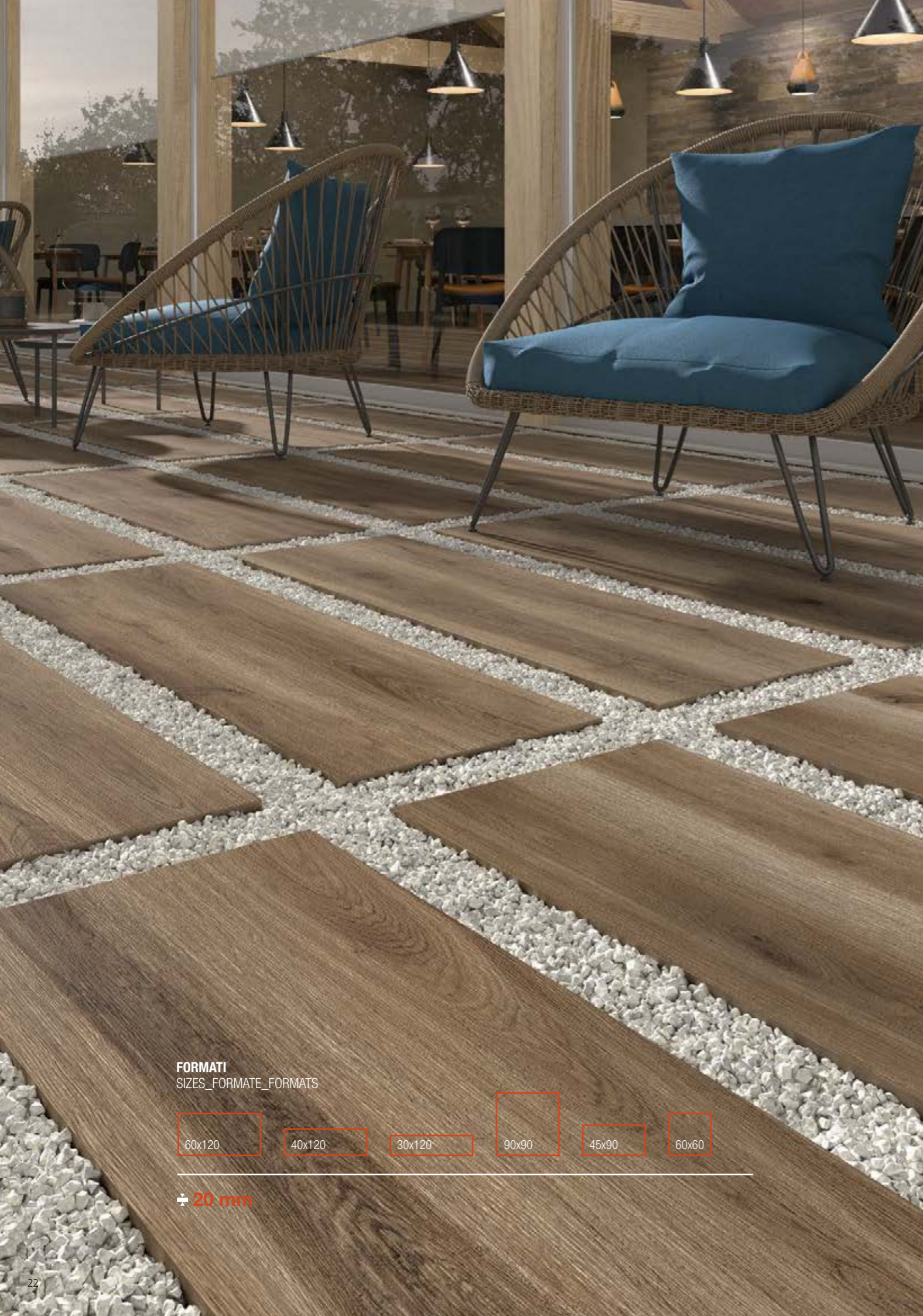

**FORMATI**  
SIZES\_FORMATE\_FORMATS

60x120 40x120 30x120 90x90 45x90 60x60

± 20 mm

20 mm

## Gres porcellanato 20 mm per outdoor

20 mm porcelain stoneware for outdoor\_20 mm Feinsteinzeug für das Outdoor\_Grès cérame 20 mm pour l'extérieur

Il gres porcellanato 20 mm è il prodotto a massima prestazione tecnica ideale per ambienti esterni, senza rischio di rotture.

20 mm porcelain stoneware has the highest technical performance of any product and is perfect for outdoor spaces, with no risk of breakage.

**RESISTENTE E FUNZIONALE**

*Elevata resistenza meccanica e allo scivolamento, altissima resistenza ai carichi di rottura.*

**FACILE E VERSATILE**

*Semplice da installare, rimuovere e riutilizzare; facile da pulire. Carrabile quando incollato su massetto.*

**UNA SUPERFICIE ETERNA**

*Materia e colori stabili nel tempo, eccezionale resistenza alle macchie.*

**ADATTO AD OGNI UTILIZZO IN ESTERNO**

*Ingelivo e ignifugo, resiste a qualsiasi agente atmosferico, agli sbalzi termici, agli acidi, alle muffe e al sale. Abbinabile ai prodotti da interno per un perfetto coordinamento estetico senza interruzioni.*

**ECOLOGICO**

*Creato nel rispetto e per la salvaguardia dell'ambiente.*

**RESISTANT AND FUNCTIONAL**

*Superior mechanical strength and slip resistance, highly resistant to heavy loads.*

**EASY AND VERSATILE**

*Simple to install, remove and reuse; easy to clean. Resistant to vehicular passage when applied to a screed with adhesives.*

**AN ETERNAL SURFACE**

*The product and its colors remain stable over time and are highly resistant to stains.*

**SUITABLE FOR ALL OUTDOOR USE**

*Resistant to frost, fire, atmospheric agents, thermal shock, acids, mold and salt. Can be combined with products for interior spaces seamlessly and without interruptions.*

**ECO-FRIENDLY**

*Manufactured in a way which respects and protects the environment.*

Das Feinsteinzeug mit 20 mm ist das Produkt mit maximaler technischer Leistung, das sich ohne Bruchgefahr ideal für Außenbereiche eignet.

Le grès cérame de 20 mm est le produit offrant le maximum de performance technique, idéal pour les espaces extérieurs, sans risque de rupture.

**BESTÄNDIG UND ZWECKMÄSSIG**

*Hohe Festigkeit und Rutschsicherheit, sehr hohe Beständigkeit gegen Bruchlasten.*

**EINFACH UND VIELSEITIG**

*Einfaches Verlegen, Entfernen und Wiederverwenden; leichte Reinigung. Befahrbar bei Verkleben auf Estrich.*

**EINE UNVERWÜSTLICHE OBERFLÄCHE**

*Material und Farben bleiben im Lauf der Zeit stabil, herausragende Fleckenbeständigkeit.*

**GEEIGNET FÜR ALLE ANWENDUNGEN IM FREIEN**

*Frost- und feuerbeständig, beständig gegen alle möglichen Witterungseinflüsse, gegen Temperaturschwankungen, Säuren, Schimmel und Salz. Kombinierbar mit Produkten für den Innenbereich für eine perfekte ästhetische Abstimmung ohne Unterbrechungen.*

**UMWELTFREUNDLICH**

*Herstellung unter Beachtung und zum Schutz der Umwelt.*

**RÉSISTANT ET FONCTIONNEL**

*Haute résistance mécanique et antidérapante, très haute résistance aux charges de rupture.*

**FACILE ET POLYVALENT**

*Facile à installer, enlever et réutiliser; facile à nettoyer. Carrossable s'il est collé sur une chape.*

**UNE SURFACE ÉTERNELLE**

*Matière et coloris stables dans le temps, exceptionnelle résistance aux taches.*

**CONVIENT À TOUTE UTILISATION EN EXTÉRIEUR**

*Résistant au gel et ignifuge, il résiste à tous les agents atmosphériques, aux changements de température, aux acides, aux moisissures et au sel. Combinable avec les produits pour intérieur pour une parfaite coordination esthétique sans interruptions.*

**ÉCOLOGIQUE**

*Créé dans le respect et la protection de l'environnement.*



**soluzioni**  
decorative

## Accenti preziosi per progetti coordinati

**Exquisite details for coordinated projects\_Kostbare Akzente  
für koordinierte Projekte\_De précieux accents pour des  
projets coordonnés**

Le collezioni Panaria si arricchiscono di decorazioni ricercate per applicazioni raffinate a rivestimento e a pavimento, capaci di dare uno stile e una personalità esclusiva ai vostri ambienti.

The Panaria collections are enhanced with refined decorations for sophisticated applications on floor and wall coverings, lending a unique style and personality to your rooms.

### **MASSIMA VERSATILITÀ DI SOLUZIONI**

*Da scoprire in un'ampia gamma di formati e varianti creative.*

### **STILE MADE IN ITALY PER DECORAZIONI ESCLUSIVE**

*Curate in ogni minimo dettaglio per spazi sofisticati e contemporanei.*

### **PROGETTI COORDINATI E INTEGRATI**

*Grazie all'abbinamento tra pavimenti e rivestimenti in gres porcellanato, gres porcellanato laminato o monoporosa in pasta bianca smaltata.*

### **MIX & MATCH DI DECORI E SUPERFICI**

*Armonia di effetti materici differenti per composizioni creative, in tonalità o a contrasto, trasversali a ogni tipologia di ambiente.*

### **SOLUTIONS THAT OFFER MAXIMUM VERSATILITY**

*Discover a wide range of sizes and creative variants.*

### **MADE IN ITALY FOR EXCLUSIVE DECORATIONS**

*Sophisticated, contemporary spaces with meticulous attention to detail.*

### **COORDINATED AND INTEGRATED PROJECTS**

*Thanks to the combination of matching wall and floor porcelain stoneware, laminated porcelain stoneware or glazed white body single-fired tiles.*

### **MIX & MATCH OF DECORATIONS AND SURFACES**

*Different harmonious tactile effects for creative compositions that match or contrast and that are suited to any kind of room.*

Die Panaria Kollektionen werden durch ausgesuchte Dekos für erlesene Verkleidungen oder Fußböden ergänzt, die Ihren Ambiente einen exklusiven Stil und eine ganz eigene Persönlichkeit geben.

Les collections Panaria se sont enrichies de décors raffinés pour des applications murales et au sol raffinées, capables de donner un style et une personnalité exclusifs à vos pièces.

### **ABSOLUT VIELSEITIGE LÖSUNGEN**

*Durch eine umfangreiche Auswahl an Formaten und kreativen Varianten.*

### **MADE IN ITALY STIL FÜR EXKLUSIVE DEKORATIONEN**

*Für raffinierte und moderne Räume bis ins kleinste Detail.*

### **KOORDINIERT UND INTEGRIERTE PROJEKTE**

*Durch die Kombination von Fußböden und Verkleidungen aus Feinsteinzeug, laminiertem Feinsteinzeug oder glasierte Weißschärbige wandfliese.*

### **MIX & MATCH VON DEKOS UND OBERFLÄCHEN**

*Harmonie zwischen verschiedenen Materialeffekten für kreative Ton-in-Ton- oder Kontrast-Kompositionen in allen Typen von Ambiente.*

### **POLYVALENCE MAXIMALE DES SOLUTIONS**

*A découvrir dans une large gamme de formats et de variations créatives.*

### **FABRIQUÉ EN STYLE ITALIEN POUR DES DÉCORATIONS EXCLUSIVES**

*Grâce à un processus de pressage unique.*

### **DES PROJETS COORDONNÉS ET INTÉGRÉS**

*Grâce à l'association entre des sols et des revêtements en grès cérame, grès cérame laminé ou faïences pâte blanche émaillé.*

### **MIX & MATCH DE DÉCORS ET DE SURFACES**

*Harmonie de différents effets matériques pour des compositions créatives, en nuances ou en contrastes, transversales à chaque type d'environnement.*



**Fiordo**

## La semplicità di abitare

The simplicity of living\_Schlichtes und elegantes Wohnen\_  
La simplicité de l'habitat

La Linea Fiordo rappresenta l'anima accessibile di Panaria: incontra ogni esigenza dell'abitare contemporaneo, grazie a superfici ceramiche essenziali ma curate, dal design immediato e trasversale, capaci di valorizzare ogni tipo di applicazione in ambito residenziale e commerciale. Un'estetica pulita e di nuova generazione, collezioni compatte, versatili e di facile scelta, contraddistinte dalla qualità tecnica ed estetica garantita da Panariagroup, per un insieme di prodotti che rinnovano costantemente il proprio stile, in linea con i trend di mercato e le esigenze di un pubblico in continuo divenire.

Die Linea Fiordo steht für den zugänglichen Panaria Geist: sie erfüllt alle Ansprüche an das moderne Wohnen durch essentielle, aber sehr gepflegte Keramikflächen mit unmittelbarem und übergreifendem Design, die jeden Anwendungstyp in Wohn- und Gewerbebereichen aufwerten. Eine klare Ästhetik der neuen Generation, kompakte, vielseitige und leicht auszuwählende Kollektionen, die sich durch die von Panariagroup garantierte technische Qualität und Ästhetik auszeichnen, für eine Gesamtheit von Produkten, die ihren Stil im Einklang mit den Markttrends und den Ansprüchen eines ständig wachsenden Publikums konstant erneuern.

The Linea Fiordo represents Panaria's accessible side: it meets every contemporary living need thanks to essential, yet meticulous surfaces with an immediate and versatile design that are capable of enhancing every type of application in residential and commercial environments. A clean and next-generation aesthetic and compact, versatile and easy-to-choose collections distinguished by the technical and aesthetic quality guaranteed by Panariagroup. The result is a set of products whose style is constantly renewed in line with market trends and the demands of an ever-changing public.

La Linea Fiordo représente l'âme accessible de Panaria: elle répond à tous les besoins de l'habitat contemporain, grâce à des surfaces céramiques essentielles mais soignées, avec un design immédiat et transversal, capables de valoriser tout type d'application dans les complexes résidentiels et commerciaux. Des lignes nettes et de nouvelle génération, collections compactes, polyvalentes et faciles à choisir, caractérisées par la qualité technique et esthétique garantie par Panariagroup, pour un ensemble de produits qui renouvellent constamment leur style, en accord avec les tendances du marché et les exigences d'un public en constante évolution.



# Il nostro Gruppo



Our Group\_ Unsere Unternehmensgruppe\_ Notre Groupe





# Panariagroup

## Nel tempo e nel mondo l'eccellenza ceramica

Throughout time and around the world, ceramic excellence\_  
Keramische Spitzenleistungen im Laufe der Zeit und Weltweit\_  
Dans le temps et dans le monde, l'excellence céramique

Eccellere, nel mondo della ceramica di alta qualità, significa saper generare sempre prodotti a elevata componente tecnologica e impreziosirli con la massima attenzione estetica, con la cura di ogni dettaglio. Per soddisfare al meglio i gusti della fascia più elevata ed esigente del mercato, Panariagroup adotta da sempre la formula dell'eccellenza, unendo storica sapienza artigianale e attitudine all'avanguardia tecnologica. Con un impegno fondamentale ad agire e operare sempre con responsabilità. Con oltre 40 anni di esperienza, Panariagroup è oggi una realtà internazionale con un cuore fortemente italiano, presente con 9 brand in oltre 130 paesi nel mondo grazie a una vasta e capillare rete commerciale.

To excel in the world of high quality ceramics means knowing how to continuously create highly technological products and how to enhance them through the utmost attention to aesthetics and detail. Panariagroup has always adhered to the highest standards of excellence, combining its history of skilful artisan craftsmanship with cutting edge technology. This approach is intrinsically linked to a fundamental commitment to always act and operate responsibly. With over 40 years of experience, Panariagroup is an international company with a strong Italian soul and an extensive sales network with 9 brands in over 130 countries all over the world.

Sich in der Welt der hochwertigen Keramik hervorzuheben, bedeutet, immer in der Lage zu sein, Produkte mit einer hohen technologischen Komponente zu erzeugen und sie mit größter Aufmerksamkeit für Ästhetik und mit Liebe zum Detail zu verschönern. Um den Geschmack des höchsten und anspruchsvollsten Marktsegments bestmöglich zu befriedigen, hat Panariagroup immer die Formel der Spitzenleistung gewählt, mit der Verbindung der historischen Handwerkskunst und technologischen Avantgarde. Mit der grundlegenden Verpflichtung, stets verantwortungsbewusst zu handeln und zu operieren. Mit mehr als 40 Jahren Erfahrung ist die Panariagroup heute eine internationale Realität mit einem starken italienischen Herzen, die dank eines breiten und kapillaren Vertriebsnetzes mit 9 Marken in mehr als 130 Ländern weltweit präsent ist.

Exceller, dans le monde de la céramique de haute qualité, signifie toujours savoir créer des produits à composante technologique élevée et les enrichir avec la plus grande attention esthétique, en soignant tous les détails. Pour satisfaire au mieux les goûts du segment le plus élevé et le plus exigeant du marché Panariagroup adopte depuis toujours la formule de l'excellence, unissant la connaissance historique artisanale et l'attitude technologiquement à l'avant-garde. Avec un engagement fondamental à agir et œuvrer toujours de manière responsable. Avec plus de 40 ans d'expérience, Panariagroup est aujourd'hui un groupe international avec un cœur fortement italien, présent avec 9 marques dans plus de 130 pays dans le monde, grâce à un vaste réseau commercial.



# Panariagroup

## Ceramiche per la qualità della vita

**Ceramics for the quality of your life\_Keramik für die Lebensqualität\_Des céramiques pour la qualité de la vie**

### **Bellezza, Innovazione, Sostenibilità**

Panariagroup è leader mondiale nei pavimenti e rivestimenti di alta qualità. Con processi produttivi che rispettano l'ambiente e prodotti pensati per un nuovo modo di concepire l'architettura e l'abitare.

### **Schönheit, Innovation, Nachhaltigkeit**

Panariagroup ist ein international führender Hersteller von qualitativ hochwertigen Wand- und Bodenbelägen. Die Produktion erfolgt umweltschonend, und die Produkte sind auf ein neues Konzept des Bauens und Wohnens ausgelegt.

### **Beauty, Innovation, Sustainability**

Panariagroup is a world leader in high quality ceramic surfaces for floor and wall coverings. Its production processes respect the environment and its products are designed for a new way of conceiving architecture and living.

### **Esthétique, Innovation, Durabilité**

Panariagroup, leader mondial des sols et revêtements de haute qualité garantit des processus de production respectueux de l'environnement et des produits conçus pour envisager l'architecture et le logement différemment.

Per conoscere di più sull'impegno e sulle iniziative concrete di Panariagroup, è possibile consultare il Bilancio di Sostenibilità 2019, scaricabile dal sito [panariagroup.it](http://panariagroup.it) o richiedibile via mail a [sustainability@panariagroup.it](mailto:sustainability@panariagroup.it)

To find out more about Panariagroup's commitment and specific initiatives, you can refer to the Sustainability Report 2019, which can be downloaded here at [panariagroup.it](http://panariagroup.it) or requested via email at [sustainability@panariagroup.it](mailto:sustainability@panariagroup.it)

Mehr zum Engagement und zu den konkreten Initiativen von Panariagroup erfahren Sie aus dem Nachhaltigkeitsbericht 2019, den Sie von der Website [panariagroup.it](http://panariagroup.it) downloaden oder per E-Mail an [sustainability@panariagroup.it](mailto:sustainability@panariagroup.it) anfordern können.

Pour en savoir plus sur les engagements et sur les initiatives concrètes de Panariagroup, vous pouvez consulter le Rapport de Durabilité 2019, téléchargeable sur le site [panariagroup.it](http://panariagroup.it) ou en envoyant une demande par e-mail à [sustainability@panariagroup.it](mailto:sustainability@panariagroup.it)



# LA CERAMICA. UNA SCELTA SICURA.

CERAMICS. A SAFE CHOICE. / KERAMIK. EINE SICHERE WAHL. / LA CÉRAMIQUE, UN CHOIX SÛR.



**SICURA**  
SAFE / SICHER / SÛRE

**IGIENICA**  
HYGIENIC / HYGIENISCH / HYGIÉNIQUE

**DURA A LUNGO**  
LONG-LASTING / LANGLEBIG / DURE LONGTEMPS

**NON EMETTE SOSTANZE CHIMICHE NOCIVE**  
ZERO VOCs / NULL VOCs / ZERO COV

**NON BRUCIA**  
IT DOES NOT BURN / BRENNT NICHT/ NE BRÛLE PAS

**RESISTENTE**  
RESISTANT / BESTÄNDIG / RÉSISTANTE

**VERSATILE**  
VERSATILE / VIELSEITIG / POLYVALENTE

**STABILE**  
STABLE / STABIL / STABLE

**RICICLABILE**  
RECYCLABLE / WIEDERVERWERTBAR / RECYCLABLE

**AMA L'AMBIENTE**  
ENVIRONMENT-FRIENDLY / UMWELTSCHONEND / RESPECTE L'ENVIRONNEMENT

## Panariagroup La ceramica nella sua forma migliore

**Ceramics at their best\_Keramik in ihrer besten Form\_  
La céramique sous sa meilleure forme**

**La ceramica è un materiale dalle prestazioni uniche e straordinarie. Panariagroup si distingue con prodotti di qualità superiore.**

Ceramics offer unique and outstanding performance. Panariagroup stands out for its superior quality products.

**PIÙ SALUBRI**  
Grazie all'integrazione della tecnologia antibatterica Protect®.

**PIÙ FACILI DA PULIRE**  
Grazie alle nostre esclusive tecniche di lavorazione delle superfici.

**PIÙ VERSATILI E ADATTI AD OGNI IMPIEGO**  
Grazie ad un'ampia disponibilità di tecnologie e componenti ad elevata performance che consentono di ottenere prodotti adatti a destinazioni d'uso differenti.

**PIÙ SOSTENIBILI**  
Grazie a un processo produttivo estremamente efficiente in termini di rispetto delle norme ambientali, del consumo di acqua, energia e materie prime.

**HEALTHIER**  
Thanks to the integrated Protect® antimicrobial technology.

**EASIER TO CLEAN**  
Thanks to our exclusive surface processing techniques.

**MORE VERSATILE AND SUITABLE FOR EVERY USE**  
Thanks to the wide availability of high-performance technologies and components that allow you to obtain products suitable for different uses.

**MORE SUSTAINABLE**  
Thanks to a production process that is extremely efficient in terms of compliance with environmental standards and consumption of water, energy and raw materials.

Keramik ist ein Material mit einzigartigen und ausgezeichneten Leistungen. Panariagroup zeichnet sich durch ihre hochwertigen Qualitätsprodukte aus.

La céramique est un matériau aux performances uniques et extraordinaires. Panariagroup se distingue par ses produits de qualité supérieure.

**GESÜNDER**  
Dank der Integration der antibakteriellen Technologie Protect®.

**EINFACHER ZU REINIGEN**  
Dank unserer exklusiven Verarbeitungstechniken der Oberflächen.

**VIELSEITIGER UND FÜR JEDEN EINSATZ GEEIGNET**  
Dank einer breiten Verfügbarkeit von Technologien und Komponenten mit hoher Leistung, die es ermöglichen, Produkte für verschiedene Einsatzbereiche zu erhalten.

**NACHHALTIGER**  
Dank einem extrem effizienten Produktionsprozess im Hinblick auf Einhaltung der Umweltnormen, sowie Wasser-, Strom- und Rohstoffverbrauch.

**PLUS SAINS**  
Grâce à l'intégration de la technologie antibactérienne Protect®.

**PLUS FACILES À NETTOYER**  
Grâce à nos techniques exclusives de traitement de surface.

**PLUS POLYVALENTS ET ADAPTÉS À TOUS LES USAGES**  
Grâce à une vaste disponibilité de technologies et de composants à haute performance, qui permettent d'obtenir des produits adaptés à des usages différents.

**PLUS DURABLES**  
Grâce à un processus de production extrêmement efficace en termes de respect des normes environnementales, de consommation d'eau, d'énergie et de matières premières.

# Le collezioni



Collections\_Kollektionen\_Collections

# La bellezza di poter scegliere la superficie ideale

The beauty of being able to choose the perfect surface\_  
Die Schönheit, die ideale Oberfläche wählen zu können\_  
La beauté de pouvoir choisir la surface idéale

Le collezioni Panaria offrono un'ampia gamma di superfici ispirate a elementi naturali e a suggestivi effetti materici, pensate per incontrare una molteplicità di stili e gusti differenti.

The Panaria collections offer a wide range of surfaces inspired by natural elements and striking material effects, designed to satisfy a variety of different styles and tastes.

Die Panaria Kollektionen bieten eine große Auswahl an Oberflächen an, die an natürlichen Elementen und an suggestiven Materialeffekten inspiriert sind und entwickelt wurden, um zahlreichen verschiedenen Stilen und Geschmacksrichtungen gerecht zu werden.

Les collections Panaria offrent une large gamme de surfaces inspirées d'éléments naturels et d'effets matériels évocateurs, conçues pour répondre à une grande variété de styles et de goûts.



**Effetto pietra**  
Stone look  
Stein-Optik  
Effet pierre



**Effetto cemento**  
Concrete look  
Zement-Optik  
Effet ciment



**Effetto marmo**  
Marble look  
Marmor-Optik  
Effet marbre



**Effetto legno**  
Wood look  
Holz-Optik  
Effet bois



**Effetto cromatico**  
Chromatic look  
Chromatischer Effekt  
Effet chromatique

# Legenda

## Legend\_Legende\_Légende

### Simbologia

Key to symbols\_Symbole\_Symbologie



**Pavimento**  
Floor  
Bodenbelag  
Revêtement de sol



**Rivestimento**  
Wall  
Wandverkleidung  
Revêtement de mur



**Spessore**  
Thickness  
Stärke  
Épaisseur



**Resistenza allo scivolamento**  
Slip resistance  
Rutschfestigkeit  
Résistance au glissement



**Resistenza all'abrasione profonda**  
Deep abrasion resistant  
Widerstand gegen Tiefenabrieb  
Résistance à l'abrasion profonde

### Grado di stonalizzazione

Shade variation\_Abtönungsgrad\_Degré de variabilité chromatique



**V0 - Aspetto molto uniforme.**  
V0 - Very uniform appearance  
V0 - Sehr gleichmäßiges Aussehen  
V0 - Aspect très uniforme

**V1 - Aspetto uniforme**  
V1 - Uniform appearance  
V1 - Gleichmäßiges Aussehen  
V1 - Aspect uniforme

**V2 - Variazioni minime**  
V2 - Slight variation  
V2 - Minimale Variationen  
V2 - Variations minimes

**V3 - Variazioni moderate**  
V3 - Moderate variation  
V3 - Mäßige Variationen  
V3 - Variations modérées

**V4 - Variazioni sostanziali**  
V4 - Substantial variation  
V4 - Wesentliche Variationen  
V4 - Variations importantes

### Decori

Decors\_Dekore\_Decors

#### CHEVRON:

**Questi formati speciali vengono realizzati con un sistema di taglio a disco senza bisello. L'eventuale presenza di leggere irregolarità del bordo e di scostamenti dimensionali fino ad 1 mm sono da ritenersi conformi**

These special formats are produced with a disc cutting system without a bevel. Any slight irregularities of the edge and size deviations of up to 1 mm should be regarded as compliant

Diese Sonderformate werden mit einem Scheibenschnittsystem ohne Fase hergestellt. Eventuelle leichte Unregelmäßigkeiten an der Kante und Größenabweichungen bis zu 1 mm sind als konform anzusehen

Ces formats spéciaux sont réalisés avec une système de découpe à disque sans biseau. L'éventuelle présence de légères irrégularités du bord et de différences de dimension jusqu'à 1 mm est tout à fait conforme

### Pezzi speciali

Trim pieces\_Spezialteile\_Pieces speciales

#### Trattandosi di pezzi artigianali possono verificarsi piccole variazioni dimensionali

Handmade pieces: light size variations may occur

Da es sich um handgemachte Teile handelt, können es kleine dimensionale Veränderungen auftreten

Étant donné qu'il s'agit de pièces faites à la main il peut y avoir des petits changements dimensionnels

#### PEZZI SPECIALI\_TRIM PIECES\_SPEZIALTEILE\_PIECES SPECIALES 20 MM:

**Venduti solo a scatole complete, lavorati solo su richiesta, consegna 30 gg**

Only full boxes sold, manufactured only upon special request, 30 days delivery

Nur als komplette Kartons verkauft, nur auf Anfrage verarbeitet, Lieferzeit 30 Tage

Vendus uniquement par boîte complète, produits uniquement à la demande, livraison 30 jours

### Destinazioni d'uso

Intended use\_Verwendungszwecke\_Domaines d'emploi



**RESIDENZIALE**\_RESIDENTIAL\_WOHNGEBIET\_RÉSIDENTIEL

**Cucine, bagni, living e ogni altro ambiente di uso residenziale.**  
Kitchens, bathrooms, living rooms and other residential environments.  
Küchen, Badezimmer, Wohnzimmer und alle sonstigen Wohnbereiche.  
Cuisines, salles de bains, salons et tout autre espace à usage résidentiel.



**ESTERNI**\_OUTDOOR\_AUSSENBEREICHE\_EXTÉRIEURS

**Prevalentemente per ambienti esterni nei quali è richiesta una pavimentazione con prestazioni antiscivolo.**  
Mainly for external areas that require flooring with anti-slip characteristics.  
Vor allem für Außenbereiche, in denen ein rutschfester Boden erforderlich ist.  
Principalement pour les environnements extérieurs où un sol antidérapant est requis.



**COMMERCIALE LEGGERO**\_LIGHT COMMERCIAL

LEICHTE GEWERBLICHE ANWENDUNGEN\_COMMERCIAL LÉGER

**Uffici, uffici aperti al pubblico, sale d'attesa, negozi, bagni pubblici, aree comuni condominiali, sale di ristoranti, autosaloni, bar, cinema, ambulatori/cliniche, camere e bagni di hotel. In aree caratterizzate da passaggi obbligati, o dove è previsto l'utilizzo di sedie con ruote in plastica dura, non è consigliato l'utilizzo di prodotti con finitura LUX.**

Offices, offices open to the general public, waiting rooms, shops, public bathrooms, common apartment block areas, restaurant dining rooms, car showrooms, bars, cinemas, surgeries/clinics, hotel rooms and bathrooms. In areas subjected to forced traffic, or areas where chairs with hard plastic wheels are used, it is not advisable to use products with the LUX finishes.

Büroräume, öffentliche Büros, Wartezimmer, Geschäfte, öffentliche Toiletten, Gemeinschaftsflächen in Mehrfamilienhäusern, Gaststätten, Autohäuser, Cafés, Kinos, Praxen/Kliniken, Hotelzimmer und -badezimmer. In Bereichen mit obligatorischen Durchgängen oder in denen Stühle mit Hartplastikrollen verwendet werden, ist der Einsatz von Produkten mit den Oberflächen LUX nicht empfohlen.

Bureaux, bureaux ouverts au public, salles d'attente, magasins, toilettes publiques, espaces communs de logements collectifs, salles de restaurants, salons automobiles, bars, cinémas, cabinets médicaux/cliniques, chambres et salles de bains d'hôtels. Dans les zones caractérisées par des passages obligatoires, ou des lieux dans lesquels des chaises à roulettes en plastique dur sont utilisées, l'utilisation de produits avec une finition LUX n'est pas recommandée.

### Note

Note\_Anmerkungen\_Remarques

**FINITURA LUX: la finitura LUX è consigliata, oltre che per rivestimenti, anche per pavimenti in ambienti residenziali o commerciale leggero non sottoposti ad elevate sollecitazioni, ove non siano richieste prestazioni antiscivolo. La presenza sporadica di piccole disuniformità o di puntini sulla superficie è da ritenersi come caratteristica del materiale e della particolare lavorazione. Qualora il prodotto sia posto a diretto contatto con l'esterno, si consiglia di utilizzare soluzioni protettive al fine di prevenire la formazione di graffi. È responsabilità del posatore provvedere sempre alla protezione della piastrellatura finita e pulita, prima della consegna al committente, tramite appositi materiali protettivi (es. pannelli in truciolare, fogli di cartone, etc.).**

LUX SURFACE FINISHES: the LUX finishes are recommended, as well as for wall cladding, also for flooring in residential or light commercial areas that are not subjected to heavy traffic, where anti-slip characteristics are not required. The occasional presence of small inconsistencies or little spots on the surface is to be considered a characteristic of the material and of its unique production process. If the product is laid in direct contact with external environments, it is recommended to use protective solutions to reduce the formation of scratches. It is the installer's responsibility to protect the finished and clean tiling before the delivery to the client, by using appropriate protective materials (e.g. chipboard, cardboard sheets, etc.).

LUX OBERFLÄCHE: die Oberfläche LUX wird nicht nur für Wandverkleidungen empfohlen, sondern auch für Böden in Wohn-bzw. Gewerbebereichen, die keiner hohen Belastung ausgesetzt sind und bei denen keine rutschhemmende Wirkung erforderlich ist. Das sporadische Vorhandensein von kleinen Unebenheiten oder Punkten auf der Oberfläche ist als ein Merkmal von Material und besonderer Verarbeitung zu betrachten. Wird das Produkt in direkten Kontakt mit der Außenseite gebracht, wird empfohlen, Schutzlösungen zu verwenden, um die Bildung von Kratzern zu vermeiden. Der Fliesenleger ist dafür zuständig, den fertig verlegten, sauberen Fliesenbelag vor der Übergabe an den Bauherrn mit geeigneten Schutzmaterialien (z.B. Spanplatten, Pappe etc.) abzudecken.

FINITION LUX: en plus des revêtements, la finition LUX est également recommandée pour les sols dans les environnements résidentiels ou commerciaux légers peu soumis à des contraintes élevées, pour lesquels aucune prestation antidérapante n'est requise. La présence sporadique de petites irrégularités ou de points à la surface doit être considérée comme une caractéristique du matériau et de sa fabrication particulière. Si le produit est placé en contact direct avec l'extérieur, il est conseillé d'utiliser des solutions de protection afin d'éviter la formation de rayures. Il incombe au carreleur de protéger le dallage fini et propre avant la livraison au client, en utilisant des matériaux de protection appropriés (e.g. panneau aggloméré, feuille de carton etc.).

**In aree caratterizzate dal passaggio di carichi pesanti concentrati non è consigliato l'utilizzo di prodotti a spessore ridotto.**

In areas that are subjected to heavy concentrated loads it is not recommended to use low thickness products.

In Bereichen, die schwerer Belastung ausgesetzt sind, ist die Verwendung von Produkten mit reduzierter Stärke nicht empfehlenswert.

Dans les zones à passage de charges lourdes concentrées, l'utilisation de produits d'épaisseur réduite n'est pas recommandée.



## Effetto pietra

Stone look\_Stein-Optik\_Effet pierre



# Bioarch



BARGE GIALLA SPAZZOLATA



BARGE GRIGIA SPAZZOLATA

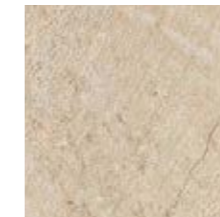

BARGE GIALLA STRUTTURATO



BARGE GRIGIA STRUTTURATO

## GRES PORCELLANATO A MASSA COLORATA\_COLOURED-BODY PORCELAIN STONEWARE



± 9 mm  
± 9,5 mm  
± 12 mm



60x60 cm Rect  
24"x24"  
60,3x60,3 cm  
24"x24"



30x60 cm Rect  
12"x24"  
30x60,3 cm  
12"x24"



15x60 cm Rect  
6"x24"



20x41 cm  
8"x16<sup>1/8</sup>"



20x30,5 cm  
8"x12"



20x20 cm  
8"x8"

## GRES PORCELLANATO A MASSA COLORATA\_COLOURED-BODY PORCELAIN STONEWARE 20 mm



± 20 mm



60x60 cm Rect  
24"x24"  
60,3x60,3 cm  
24"x24"





PAVIMENTO / FLOOR Barge Grigia Strutturato 20x20 cm - 8"x8" \_20x30,5 cm - 8"x12" \_20x41 cm - 8"x16<sup>1/8</sup>"



RIVESTIMENTO / WALL Barge Gialla Spazzolata 15x60 cm Rect - 6"x24" \_Bio Wood Barge Gialla spazzolata 30x30 cm Rect - 12"x12"  
Bio Line Barge Gialla Spazzolata 30x60 cm Rect - 12"x24"  
PAVIMENTO / FLOOR Barge Gialla Spazzolata 60x60 cm Rect - 24"x24"



PAVIMENTO / FLOOR Barge Grigia Spazzolata 60x60 cm Rect - 24"x24" \_Bio Line Barge Grigia Spazzolata 30x60 cm Rect - 12"x24"



PAVIMENTO / FLOOR Barge Grigia Strutturato 60x60 cm Rect - 24"x24" 20 mm

## BARGE GIALLA SPAZZOLATA



## BARGE GRIGIA SPAZZOLATA



## BARGE GIALLA STRUTTURATO



## BARGE GRIGIA STRUTTURATO



## GRES PORCELLANATO A MASSA COLORATA\_COLOURED-BODY PORCELAIN STONEWARE

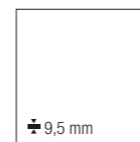

60x60 cm Rect - 24"x24"

Barge Gialla Spazzolata PGWBK201  
Barge Grigia Spazzolata PGWBK301

60,3x60,3 cm - 24"x24"  
Barge Gialla Spazzolata PGWBK001  
Barge Grigia Spazzolata PGWBK101

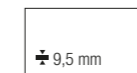

30x60 cm Rect - 12"x24"

Barge Gialla Spazzolata PG-BK201  
Barge Grigia Spazzolata PG-BK301



15x60 cm Rect - 6"x24"

Barge Gialla Spazzolata PG1BK201  
Barge Grigia Spazzolata PG1BK301



30x60,3 cm - 12"x24"

Barge Gialla Strutturato PG-BK00  
Barge Grigia Strutturato PG-BK10



20x41 cm - 8"x16<sup>1/8</sup>"

Barge Gialla Strutturato PGKBK05  
Barge Grigia Strutturato PGKBK15



20x30,5 cm - 8"x12"

Barge Gialla Strutturato PGBBK05  
Barge Grigia Strutturato PGBBK15



20x20 cm - 8"x8"

Barge Gialla Strutturato PGEBK05  
Barge Grigia Strutturato PGEBK15

## GRES PORCELLANATO A MASSA COLORATA\_COLOURED-BODY PORCELAIN STONEWARE **20 mm**



60x60 cm Rect - 24"x24"

Barge Gialla Strutturato PGWBKS0  
Barge Grigia Strutturato PGWBKS1

60,3x60,3 cm - 24"x24"  
Barge Gialla Strutturato PGWBK0S  
Barge Grigia Strutturato PGWBK1S

DESTINAZIONI D'USO\_INTENDED USE: SPAZZOLATA STRUTTURATO

### DATI TECNICI\_TECHNICAL DATA:

GRES PORCELLANATO A MASSA COLORATA COLOURED-BODY PORCELAIN STONEWARE		GRES PORCELLANATO A MASSA COLORATA COLOURED-BODY PORCELAIN STONEWARE	
9 / 9,5 / 12 mm		20 mm	
DIN 51130: R11 Strutturato R10 Spazzolata	DIN 51130: R11 Strutturato	DIN 51130: R11 Strutturato	DIN 51130: R11 Strutturato
DIN 51097: C (A+B+C) Strutturato A Spazzolata	DIN 51097: C (A+B+C) Strutturato	DIN 51097: C (A+B+C) Strutturato	DIN 51097: C (A+B+C) Strutturato
BCR TORTUS: μ > 0,40 Spazzolata - Strutturato	BCR TORTUS: μ > 0,40 Strutturato	BCR TORTUS: μ > 0,40 Strutturato	BCR TORTUS: μ > 0,40 Strutturato
ANSI A326.3: DCOF ≥ 0,42 Spazzolata - Strutturato	ANSI A326.3: DCOF ≥ 0,42 Strutturato	ANSI A326.3: DCOF ≥ 0,42 Strutturato	ANSI A326.3: DCOF ≥ 0,42 Strutturato
BS 7976-2: PTV 36+WET (SI.96) Strutturato	BS 7976-2: PTV 36+WET (SI.96) Strutturato	BS 7976-2: PTV 36+WET (SI.96) Strutturato	BS 7976-2: PTV 36+WET (SI.96) Strutturato
EN 101: MOHS 9	EN 101: MOHS 9	EN 101: MOHS 9	EN 101: MOHS 9
CTI 81-7 ANNEX A: MOHS 9	CTI 81-7 ANNEX A: MOHS 9	CTI 81-7 ANNEX A: MOHS 9	CTI 81-7 ANNEX A: MOHS 9
ANSI A137.1: V4 Strutturato V3 Spazzolata	ANSI A137.1: V3 Strutturato	ANSI A137.1: V3 Strutturato	ANSI A137.1: V3 Strutturato

## SOLUZIONI DI POSA\_LAYING SOLUTIONS

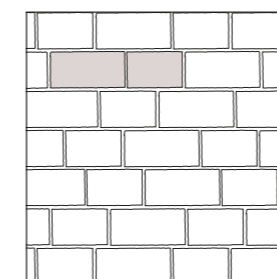

20x30,5 (42,66%) - 20x41 (57,34%)

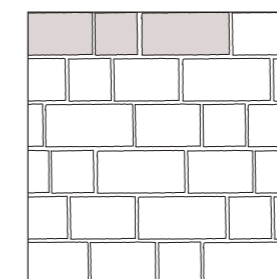

20x20 (21,86%) - 20x30,5 (33,33%)  
20x41 (44,81%)

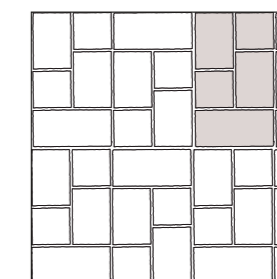

20x20 (28,17%) - 20x30,5 (42,96%)  
20x41 (28,87%)

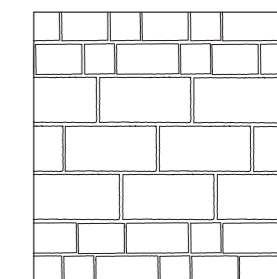

20x20 - 20x30,5 - 20x41  
30x60,3

Fuga consigliata: vedi pag. 419\_Suggested joint: see pag. 419\_Empfohlene Fuge: siehe Seite 419\_Joint conseillé : voir page 419

## DECORI\_DECORS

GRES PORCELLANATO A MASSA COLORATA\_COLOURED-BODY PORCELAIN STONEWARE

### BARGE GIALLA SPAZZOLATA



**MURETTO SPAZZOLATA**  
29,7x58,4 cm Rect - 11<sup>3/4</sup>"x23"  
± 9,5 mm  
PG-BK2M



**BIO FOREST SPAZZOLATA**  
30x60 cm Rect - 12"x24"  
± 9,5 mm  
PG-BK26



**BIO LINE SPAZZOLATA**  
30x60 cm Rect - 12"x24"  
± 9,5 mm  
PG-BK27

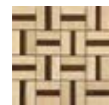

**BIO WOOD SPAZZOLATA**  
30x30 cm Rect - 12"x12"  
± 9,5 mm  
PGZBK25

### BARGE GRIGIA SPAZZOLATA



**MURETTO SPAZZOLATA**  
29,7x58,4 cm Rect - 11<sup>3/4</sup>"x23"  
± 9,5 mm  
PG-BK3M



**BIO FOREST SPAZZOLATA**  
30x60 cm Rect - 12"x24"  
± 9,5 mm  
PG-BK36



**BIO LINE SPAZZOLATA**  
30x60 cm Rect - 12"x24"  
± 9,5 mm  
PG-BK37



**BIO WOOD SPAZZOLATA**  
30x30 cm Rect - 12"x12"  
± 9,5 mm  
PGZBK35

### BIO FOREST:

Posare solo a parete\_Recommended only for wall applications\_Nur an der Wand verlegen\_Recommandé seulement pour les revêtements

## PEZZI SPECIALI\_TRIM PIECES

GRES PORCELLANATO A MASSA COLORATA\_COLOURED-BODY PORCELAIN STONEWARE

<b>BATTISCOPIA</b> 10x60 cm Rect - 4"x24" ± 10 mm	<b>BATTISCOPIA</b> 10x60,3 cm - 4"x24" ± 10 mm	<b>GRADONE TORO VUOTO BORDO</b> 30x34 cm Rect - 12"x13 <sup>3/8</sup> " ± 9,5 mm	<b>GRADONE TORO VUOTO ANGOLARE</b> 34x34 cm - 13 <sup>3/8</sup> "x13 <sup>3/8</sup> " ± 9,5 mm	<b>RACCORDO*</b> 1,2x30 cm Rect - 1/2"x12" ± 9,5 mm	<b>ANGOLO RACCORDO*</b> 1,2x1,2 cm - 1/2"x1/2" ± 9,5 mm
BARGE GIALLA SPAZZOLATA <b>PGRBK21</b>	BARGE GIALLA SPAZZOLATA <b>PGRBK27</b>	BARGE GIALLA SPAZZOLATA <b>PGEBK20</b>	BARGE GIALLA SPAZZOLATA <b>PGEBK21</b>	BARGE GIALLA SPAZZOLATA <b>PGZBK21</b>	BARGE GIALLA SPAZZOLATA <b>PGZBK22</b>
BARGE GRIGIA SPAZZOLATA <b>PGRBK31</b>	BARGE GRIGIA SPAZZOLATA <b>PGRBK37</b>	BARGE GRIGIA SPAZZOLATA <b>PGEBK30</b>	BARGE GRIGIA SPAZZOLATA <b>PGEBK31</b>	BARGE GRIGIA SPAZZOLATA <b>PGZBK31</b>	BARGE GRIGIA SPAZZOLATA <b>PGZBK32</b>
<b>BATTISCOPIA SCALA DX</b> (kit 2 pezzi) 10x45 cm - 4"x18" ± 10 mm	<b>BATTISCOPIA SCALA SX</b> (kit 2 pezzi) 10x45 cm - 4"x18" ± 10 mm	<b>GRADINO**</b> 30x30 cm Rect - 12"x12" ± 9,5 mm	<b>GRADONE A COSTA RETTA</b> 30x34 cm - 12"x13 <sup>3/8</sup> " ± 12 mm	<b>ELEMENTO "L"</b> 15x30x4 cm - 6"x12"x1 <sup>9/16</sup> " ± 9 mm	
BARGE GIALLA SPAZZOLATA <b>PGZBKD2</b>	BARGE GIALLA SPAZZOLATA <b>PGZBKS2</b>	BARGE GIALLA SPAZZOLATA <b>PGDBK20</b>	BARGE GIALLA STRUTTURATO <b>PGEBK00</b>	BARGE GIALLA STRUTTURATO <b>PGZBKA0</b>	
BARGE GRIGIA SPAZZOLATA <b>PGZBKD3</b>	BARGE GRIGIA SPAZZOLATA <b>PGZBKS3</b>	BARGE GRIGIA SPAZZOLATA <b>PGDBK30</b>	BARGE GRIGIA STRUTTURATO <b>PGEBK10</b>	BARGE GRIGIA STRUTTURATO <b>PGZBKA1</b>	

\* Posare solo all'interno\_Strictly for interiors\_Nur im Innenraum zu verlegen\_Poser seulement à l'intérieur

\*\* Privo di fresature antiscivolo\_Version without non-slip milled cuts\_Ohne rutschhemmnde Rillen\_Marce sans rainures antidérapant

## PEZZI SPECIALI\_TRIM PIECES

GRES PORCELLANATO A MASSA COLORATA\_COLOURED-BODY PORCELAIN STONEWARE **20 mm**

<b>COSTA TORO ANGOLARE DX</b> 30x60 cm Rect - 12"x24"	<b>COSTA TORO ANGOLARE SX</b> 30x60 cm Rect - 12"x24"	<b>COSTA TORO</b> 30x60 cm Rect - 12"x24"	<b>COSTA TORO GRIP</b> 30x60 cm Rect - 12"x24"	<b>COSTA RETTA ANGOLARE DX</b> 30x60 cm Rect - 12"x24"	<b>COSTA RETTA ANGOLARE SX</b> 30x60 cm Rect - 12"x24"
BARGE GIALLA STRUTTURATO <b>PGDBKK2</b>	BARGE GIALLA STRUTTURATO <b>PGDBKK0</b>	BARGE GIALLA STRUTTURATO <b>PGDBKF0</b>	BARGE GIALLA STRUTTURATO <b>PGDBKJ0</b>	BARGE GIALLA STRUTTURATO <b>PGDBKD2</b>	BARGE GIALLA STRUTTURATO <b>PGDBKD0</b>
BARGE GRIGIA STRUTTURATO <b>PGDBKK3</b>	BARGE GRIGIA STRUTTURATO <b>PGDBKK1</b>	BARGE GRIGIA STRUTTURATO <b>PGDBKF1</b>	BARGE GRIGIA STRUTTURATO <b>PGDBKJ1</b>	BARGE GRIGIA STRUTTURATO <b>PGDBKD3</b>	BARGE GRIGIA STRUTTURATO <b>PGDBKD1</b>
<b>COSTA RETTA</b> 30x60 cm Rect - 12"x24"	<b>COSTA RETTA GRIP</b> 30x60 cm Rect - 12"x24"	<b>GRIGLIA ANGOLARE DX</b> 15x60 cm Rect - 6"x24"	<b>GRIGLIA ANGOLARE SX</b> 15x60 cm Rect - 6"x24"	<b>GRIGLIA</b> 15x60 cm Rect - 6"x24"	
BARGE GIALLA STRUTTURATO <b>PGDBKCO</b>	BARGE GIALLA STRUTTURATO <b>PGDBKGO</b>	BARGE GIALLA STRUTTURATO <b>PGDBKA2</b>	BARGE GIALLA STRUTTURATO <b>PGDBKA0</b>	BARGE GIALLA STRUTTURATO <b>PGDBKZO</b>	
BARGE GRIGIA STRUTTURATO <b>PGDBKCI</b>	BARGE GRIGIA STRUTTURATO <b>PGDBKI1</b>	BARGE GRIGIA STRUTTURATO <b>PGDBKA3</b>	BARGE GRIGIA STRUTTURATO <b>PGDBKA1</b>	BARGE GRIGIA STRUTTURATO <b>PGDBKZI</b>	

## IMBALLAGGI E PESI\_PACKINGS AND WEIGHTS

DESCRIZIONE Description	± mm	FORMATI Sizes	SCATOLA_Box				PALLET		
FONDO STRUTTURATO	12	30x60,3	7	32,2	1,266	-	32	1030,4	40,52
FONDO STRUTTURATO	9	20x41	13	21	1,066	-	54	1134	57,56
FONDO STRUTTURATO	9	20x30,5	20	23,1	1,22	-	48	1108,8	58,56
FONDO STRUTTURATO	9	20x20	30	25	1,2	-	45	1125	54
FONDO SPAZZOLATA	9,5	60x60 RECT	4	31,8	1,44	-	32	1017,6	46,08
FONDO SPAZZOLATA	9,5	60,3x60,3	4	31,8	1,454	-	32	1017,6	46,54
FONDO SPAZZOLATA	9,5	30x60 RECT	8	31,8	1,44	-	32	1018	46,1
FONDO SPAZZOLATA	9,5	15x60 RECT	12	23,318	1,08	-	40	932,727	43,2
BIO FOREST SPAZZOLATA	9,5	30x60 RECT	5	21,5	0,9	-	-	-	-
BIO LINE SPAZZOLATA	9,5	30x60 RECT	4	15,7	0,72	-	30	471	21,6
BIO WOOD SPAZZOLATA	9,5	30x30 RECT	4	7,5	0,36	-	60	450	21,6
MURETTO SPAZZOLATA	9,5	29,7x58,4 RECT	4	15,7	0,69	-	30	471	20,8
RACCORDO SPAZZOLATA	-	1,2x30 RECT	8	0,4	0,028	-	-	-	-
ANGOLO RACCORDO SPAZZOLATA	-	1,2x1,2	10	0,07	0,001	-	-	-	-
BATTISCOPIA SPAZZOLATA	10	10x60 RECT	12	15,48	0,72	7,2	60	928,8	43,2
BATTISCOPIA SPAZZOLATA	10	10x60,3	16	20	0,9648	9,648	48	960	46,31
BATTISCOPIA SCALA (KIT 2 PZ.) SPAZZOLATA	10	10x45	5	8,5	0,425	-	-	-	-
GRADONE TORO VUOTO BORDO SPAZZOLATA	9,5	30x34 RECT	6	15,4	0,61	-	30	462	18,36
GRADONE TORO VUOTO ANGOLARE SPAZZOLATA	9,5	34x34	2	5,432	0,223	-	46	249,87	10,26
GRADINO SPAZZOLATA	9,5	30x30 RECT	12	23,422	1,08	-	40	936,87	43,2
GRADONE A COSTA RETTA STRUTTURATO	12	30x34	6	21	0,612	1,2	30	630	18,36
ELEMENTO "L" STRUTTURATO	9	15x30x4	8	9,6	0,36	2,4	48	460,8	17,28
FONDO STRUTTURATO	20	60x60 RECT	2	33	0,72	-	32	1056	23,04
FONDO STRUTTURATO	20	60,3x60,3	2	33,3	0,73	-	32	1065,6	23,27
COSTA TORO STRUTTURATO	20	30x60 RECT	1	8,13	0,135	-	100	813	13,5
COSTA TORO ANGOLARE STRUTTURATO	20	30x60 RECT	1	6,1	0,135	-	100	610	13,5
COSTA TORO GRIP STRUTTURATO	20	30x60 RECT	1	8,13	0,135	-	100	813	13,5
COSTA RETTA STRUTTURATO	20	30x60 RECT	1	8,13	0,135	-	100	813	13,5
COSTA RETTA ANGOLARE STRUTTURATO	20	30x60 RECT	1	6,1	0,135	-	100	610	13,5
COSTA RETTA GRIP STRUTTURATO	20	30x60 RECT	1	8,13	0,135	-	100	813	13,5
GRIGLIA STRUTTURATO	20	15x60 RECT	2	8	0,158	-	100	800	15,75
GRIGLIA ANGOLARE STRUTTURATO	20	15x60 RECT	2	7	0,158	-	100	700	15,75



# Discover



WHITE



SUN



PLAN



ORIGIN

GRES PORCELLANATO A MASSA COLORATA\_COLOURED-BODY PORCELAIN STONEWARE



± 9 mm  
± 9,5 mm  
± 10 mm



60x60 cm Rect  
24"x24"  
60,3x60,3 cm  
24"x24"



30x60 cm Rect  
12"x24"  
30x60,3 cm  
12"x24"



20x60 cm Rect  
8"x24"



15x60 cm Rect  
6"x24"



7,5x60 cm Rect  
3"x24"



5x60 cm Rect  
2"x24"

GRES PORCELLANATO A MASSA COLORATA\_COLOURED-BODY PORCELAIN STONEWARE **20 mm**



± 20 mm



60x120 cm Rect  
24"x48"



60x60 cm Rect  
24"x24"  
60,3x60,3 cm  
24"x24"



PAVIMENTO / FLOOR Plan Naturale 15x60 cm Rect - 6"x24" \_20x60 cm Rect - 8"x24" \_30x60 cm Rect - 12"x24"  
Plan Strutturato 30x60,3 cm - 12"x24"



RIVESTIMENTO / WALL White Naturale 30x60 cm Rect - 12"x24" \_Mosaico a sbalzo White Naturale 30x30 cm Rect - 12"x12"  
PAVIMENTO / FLOOR Origin Naturale 60x60 cm Rect - 24"x24"

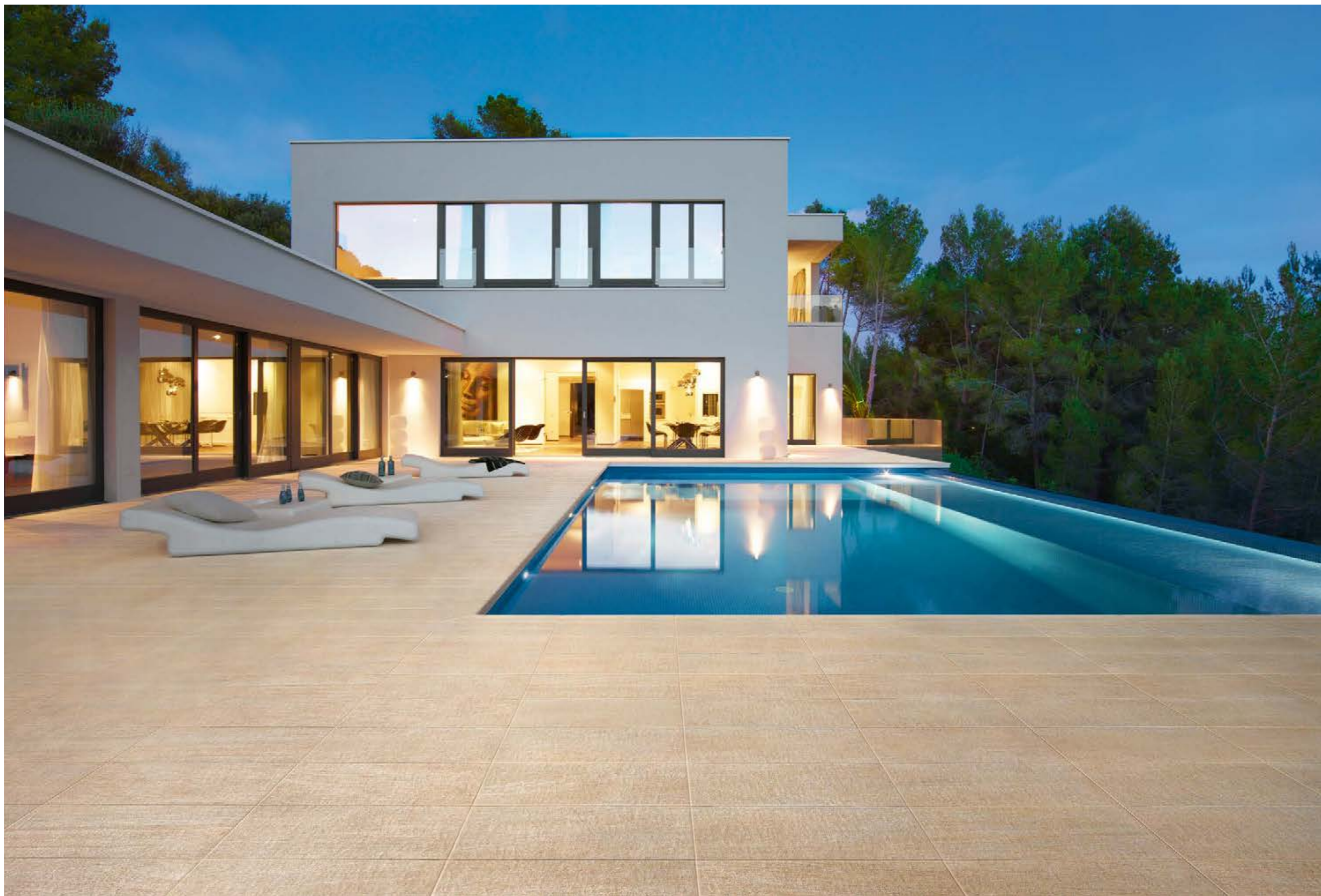

PAVIMENTO / FLOOR Sun Strutturato 30x60,3 cm - 12"x24"





PAVIMENTO / FLOOR White Strutturato 60,3x60,3 cm - 24"x24" 20 mm

# Discover

**PROTECT**  
ANTIBATTERICO - ANTIMICROBIAL

## WHITE



## SUN



## PLAN



## ORIGIN



# Discover

## GRES PORCELLANATO A MASSA COLORATA\_COLOURED-BODY PORCELAIN STONEWARE



**60x60 cm Rect - 24"x24"**  
**White** NATURALE PGWDI31P  
**Sun** NATURALE PGWDI21P  
**Plan** NATURALE PGWDI11P  
**Origin** NATURALE PGWDI01P  
**60,3x60,3 cm - 24"x24"**  
**White** NATURALE PGWDI30P  
**Sun** NATURALE PGWDI20P  
**Plan** NATURALE PGWDI10P  
**Origin** NATURALE PGWDI00P

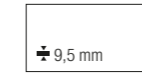

**30x60 cm Rect - 12"x24"**  
**White** NATURALE PG-DI31  
**Sun** NATURALE PG-DI21  
**Plan** NATURALE PG-DI11  
**Origin** NATURALE PG-DI01



**30x60,3 cm - 12"x24"**  
**White** NATURALE PG-DI30  
**Sun** NATURALE PG-DI20  
**Plan** NATURALE PG-DI10  
**Origin** NATURALE PG-DI00



**20x60 cm Rect - 8"x24"**  
**White** NATURALE PG2DI30  
**Sun** NATURALE PG2DI20  
**Plan** NATURALE PG2DI10  
**Origin** NATURALE PG2DI00

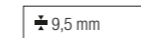

**15x60 cm Rect - 6"x24"**  
**White** NATURALE PG1DI30  
**Sun** NATURALE PG1DI20  
**Plan** NATURALE PG1DI10  
**Origin** NATURALE PG1DI00



**7,5x60 cm Rect - 3"x24"**  
**White** NATURALE PGRDI30  
**Sun** NATURALE PGRDI20  
**Plan** NATURALE PGRDI10  
**Origin** NATURALE PGRDI00

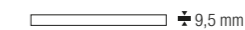

**5x60 cm Rect - 2"x24"**  
**White** NATURALE PG0DI30  
**Sun** NATURALE PG0DI20  
**Plan** NATURALE PG0DI10  
**Origin** NATURALE PG0DI00



**30x60,3 cm - 12"x24"**  
**White** STRUTTURATO\* PG-DIS3  
**Sun** STRUTTURATO\* PG-DIS2  
**Plan** STRUTTURATO\* PG-DIS1  
**Origin** STRUTTURATO\* PG-DIS0

## GRES PORCELLANATO A MASSA COLORATA\_COLOURED-BODY PORCELAIN STONEWARE **20 mm**

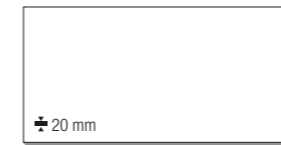

**60x120 cm Rect - 24"x48"**  
**White** STRUTTURATO\* PGXDIS31  
**Sun** STRUTTURATO\* PGXDIS21  
**Origin** STRUTTURATO\* PGXDIS01



**60x60 cm Rect - 24"x24"**  
**White** STRUTTURATO\* PGWDIS8  
**Sun** STRUTTURATO\* PGWDIS7  
**Origin** STRUTTURATO\* PGWDIS5  
**60,3x60,3 cm Rect - 24"x24"**  
**White** STRUTTURATO\* PGWDIS3  
**Sun** STRUTTURATO\* PGWDIS2P  
**Origin** STRUTTURATO\* PGWDIS0P

DESTINAZIONI D'USO\_INTENDED USE: NATURALE STRUTTURATO

### DATI TECNICI\_TECHNICAL DATA:

GRES PORCELLANATO A MASSA COLORATA COLOURED-BODY PORCELAIN STONEWARE	GRES PORCELLANATO A MASSA COLORATA COLOURED-BODY PORCELAIN STONEWARE
9 / 9,5 / 10 mm	20 mm
DIN 51130: <b>R9</b> Naturale <b>R11</b> Strutturato DIN 51097: <b>C (A+B+C)</b> Strutturato BCR TORTUS: $\mu > 0,40$ Naturale - Strutturato ANSI A326.3: <b>DCOF <math>\geq 0,42</math></b> Naturale - Strutturato BS 7976-2: <b>PTV 36+WET (SI.96 - SI.55)</b> Strutturato	DIN 51130: <b>R11</b> Strutturato DIN 51097: <b>C (A+B+C)</b> Strutturato BCR TORTUS: $\mu > 0,40$ Strutturato ANSI A326.3: <b>DCOF <math>\geq 0,42</math></b> Strutturato BS 7976-2: <b>PTV 36+WET (SI.96 - SI.55)</b> Strutturato
ANSI A137.1: <b>V2</b> Naturale - Strutturato	ANSI A137.1: <b>V2</b> Strutturato
<b>PROTECT</b> ANTIBATTERICO - ANTIMICROBIAL Naturale	

\* Protezione antibatterica non presente\_No antimicrobial protection\_Der Antibakterielle Schutz nicht vorhanden\_Protection antibactérienne pas présente

# Discover

## DECORI\_DECORS

GRES PORCELLANATO A MASSA COLORATA\_COLOURED-BODY PORCELAIN STONWARE

### WHITE



**MOSAICO A SBALZO NATURALE**  
30x30 cm Rect - 12"x12"  
± 9,5 mm  
PGZDI3M

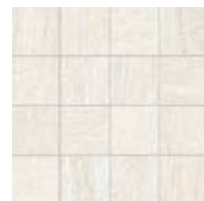

**MOSAICO 16 PEZZI NATURALE**  
30x30 cm Rect - 12"x12"  
± 9,5 mm  
PGZDI35

### SUN

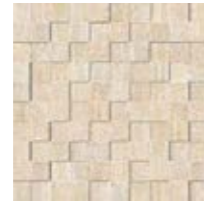

**MOSAICO A SBALZO NATURALE**  
30x30 cm Rect - 12"x12"  
± 9,5 mm  
PGZDI2M

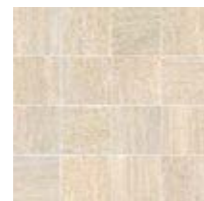

**MOSAICO 16 PEZZI NATURALE**  
30x30 cm Rect - 12"x12"  
± 9,5 mm  
PGZDI25

### PLAN



**MOSAICO A SBALZO NATURALE**  
30x30 cm Rect - 12"x12"  
± 9,5 mm  
PGZDI1M



**MOSAICO 16 PEZZI NATURALE**  
30x30 cm Rect - 12"x12"  
± 9,5 mm  
PGZDI15

### ORIGIN



**MOSAICO A SBALZO NATURALE**  
30x30 cm Rect - 12"x12"  
± 9,5 mm  
PGZDI0M

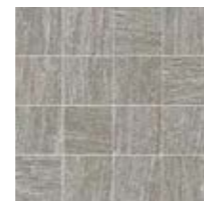

**MOSAICO 16 PEZZI NATURALE**  
30x30 cm Rect - 12"x12"  
± 9,5 mm  
PGZDI05



#### MOSAICO A SBALZO:

Posare solo a parete\_Recommended only for wall applications\_Nur an der Wand verlegen\_Recommandé seulement pour les revêtements

## PEZZI SPECIALI\_TRIM PIECES

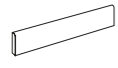
GRES PORCELLANATO A MASSA COLORATA\_COLOURED-BODY PORCELAIN STONWARE

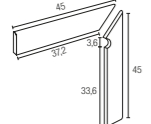
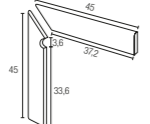
						
	<b>BATTISCOPA</b> 10x60 cm Rect - 4"x24" ± 10 mm NATURALE	<b>BATTISCOPA</b> 10x60,3 cm - 4"x24" ± 10 mm NATURALE	<b>GRADONE TORO VUOTO BORDO</b> 30x34 cm Rect - 12"x13 <sup>3/8</sup> " ± 9,5 mm NATURALE	<b>GRADONE TORO VUOTO ANGOLARE DX</b> 34x34 cm - 13 <sup>3/8</sup> "x13 <sup>3/8</sup> " ± 9,5 mm NATURALE	<b>GRADONE TORO VUOTO ANGOLARE SX</b> 34x34 cm - 13 <sup>3/8</sup> "x13 <sup>3/8</sup> " ± 9,5 mm NATURALE	<b>GRADINO</b> 30x30 cm Rect - 12"x12" ± 9,5 mm NATURALE
WHITE	PGDIR3	PGDIB3	PGEDI30	PGEDI31	PGEDI32	PGDDI30
SUN	PGDIR2	PGDIB2	PGEDI20	PGEDI21	PGEDI22	PGDDI20
PLAN	PGDIR1	PGDIB1	PGEDI10	PGEDI11	PGEDI12	PGDDI10
ORIGIN	PGDIR0	PGDIB0	PGEDI00	PGEDI01	PGEDI02	PGDDI00

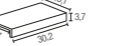
					
	<b>BATTISCOPA SCALA DX</b> (kit 2 pezzi) 10x45 cm - 4"x18" ± 10 mm NATURALE	<b>BATTISCOPA SCALA SX</b> (kit 2 pezzi) 10x45 cm - 4"x18" ± 10 mm NATURALE	<b>RACCORDO*</b> 1x30 cm Rect - 3/8"x12" ± 10 mm NATURALE	<b>ANGOLO RACCORDO*</b> 1x1 cm - 3/8"x3/8" ± 10 mm NATURALE	<b>ELEMENTO "L"*</b> 15x30x4 cm - 4"x12"x1 <sup>3/8</sup> " ± 9 mm STRUTTURATO
WHITE	PGZDI3D	PGZDI3S	PGZDI30	PGZDI31	PGZDI3
SUN	PGZDI2D	PGZDI2S	PGZDI20	PGZDI21	PGZDI2
PLAN	PGZDI1D	PGZDI1S	PGZDI10	PGZDI11	PGZDI1
ORIGIN	PGZDI0D	PGZDI0S	PGZDI00	PGZDI01	PGZDI0

#### RACCORDO - ANGOLO RACCORDO:



Posare solo all'interno\_Strictly for interiors\_Nur im Innenraum zu verlegen\_Poser seulement à l'intérieur

\* Protezione antibatterica non presente\_No antimicrobial protection\_Der Antibakterielle Schutz nicht vorhanden\_Protection antibactérienne pas présente

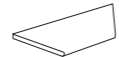
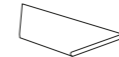

# Discover

## PEZZI SPECIALI\_TRIM PIECES

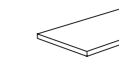
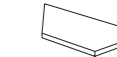
GRES PORCELLANATO A MASSA COLORATA\_COLOURED-BODY PORCELAIN STONWARE **20 mm**



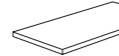
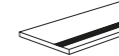
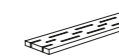

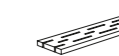

						
	<b>COSTA TORO ANGOLARE DX</b> 30x60 cm Rect - 12"x24" STRUTTURATO*	<b>COSTA TORO ANGOLARE SX</b> 30x60 cm Rect - 12"x24" STRUTTURATO*	<b>COSTA TORO</b> 30x60 cm Rect - 12"x24" STRUTTURATO*	<b>COSTA TORO GRIP</b> 30x60 cm Rect - 12"x24" STRUTTURATO*	<b>COSTA RETTA ANGOLARE DX</b> 30x60 cm Rect - 12"x24" STRUTTURATO*	<b>COSTA RETTA ANGOLARE SX</b> 30x60 cm Rect - 12"x24" STRUTTURATO*
WHITE	PGDDIK6	PGDDIK3	PGDDIF3	PGDDIJ3	PGDDID6	PGDDID3
SUN	PGDDIK5	PGDDIK2	PGDDIF2	PGDDIJ2	PGDDID5	PGDDID2
ORIGIN	PGDDIK4	PGDDIK0	PGDDIF0	PGDDIJ0	PGDDID4	PGDDID0

					
	<b>COSTA RETTA</b> 30x60 cm Rect - 12"x24" STRUTTURATO*	<b>COSTA RETTA GRIP</b> 30x60 cm Rect - 12"x24" STRUTTURATO*	<b>GRIGLIA ANGOLARE DX</b> 15x60 cm Rect - 6"x24" STRUTTURATO*	<b>GRIGLIA ANGOLARE SX</b> 15x60 cm Rect - 6"x24" STRUTTURATO*	<b>GRIGLIA</b> 15x60 cm Rect - 6"x24" STRUTTURATO*
WHITE	PGDDIC3	PGDDIG3	PGDDIA6	PGDDIA3	PGDDIZ3
SUN	PGDDIC2	PGDDIG2	PGDDIA5	PGDDIA2	PGDDIZ2
ORIGIN	PGDDIC0	PGDDIG0	PGDDIA4	PGDDIA0	PGDDIZ0

\* Protezione antibatterica non presente\_No antimicrobial protection\_Der Antibakterielle Schutz nicht vorhanden\_Protection antibactérienne pas présente

## IMBALLAGGI E PESI\_PACKINGS AND WEIGHTS

DESCRIZIONE Description	± mm	FORMATI Sizes	SCATOLA_Box				PALLET		
									
FONDO NATURALE	9,5	60x60 RECT	4	31,8	1,44	-	32	1018	46,1
FONDO NATURALE	9,5	60,3x60,3	4	31,8	1,46	-	32	1018	46,72
FONDO NATURALE	9,5	30x60 RECT	8	31,8	1,44	-	32	1018	46,1
FONDO NATURALE	10	30x60,3	8	32,2	1,447	-	32	1030,4	46,31
FONDO STRUTTURATO	9	30x60,3	9	33,45	1,628	-	32	1070,4	52,099
FONDO NATURALE	9,5	20x60 RECT	13	31,9	1,56	-	30	957	46,8
FONDO NATURALE	9,5	15x60 RECT	16	29,5	1,44	-	32	944	46,1
FONDO NATURALE	9,5	7,5x60 RECT	15	14,9	0,68	-	40	596	27,2
FONDO NATURALE	9,5	5x60 RECT	15	9,4	0,45	-	64	601,6	28,8
MOSAICO 16 PEZZI NATURALE	9,5	30x30 RECT	4	7,2	0,36	-	78	562	28,1
MOSAICO A SBALZO NATURALE	9,5	30x30 RECT	4	7,2	0,36	-	78	562	28,1
RACCORDO NATURALE	-	1x30 RECT	8	0,8	0,024	-	-	-	-
ANGOLO RACCORDO NATURALE	-	1x1	10	0,07	0,001	-	-	-	-
BATTISCOPA NATURALE	10	10x60,3	16	20	0,9648	9,648	48	960	46,31
BATTISCOPA NATURALE	10	10x60 RECT	12	15,48	0,72	7,2	60	928,8	43,2
BATTISCOPA SCALA (KIT 2 PZ.) NATURALE	10	10x45	5	8,5	0,425	-	-	-	-
GRADINO NATURALE	9,5	30x30 RECT	13	25,9	1,17	-	40	1036	46,8
GRADONE TORO VUOTO BORDO NATURALE	9,5	30x34 RECT	6	14,8	0,612	-	30	444	18,4
GRADONE TORO VUOTO ANGOLARE NATURALE	9,5	34x34	2	5,4	0,22	-	46	248,4	10,12
ELEMENTO "L" STRUTTURATO	9	15x30x4	8	9,6	0,36	2,4	48	460,8	17,28
FONDO STRUTTURATO	20	60x120 RECT	1	32,5	0,72	-	32	1040	23,04
FONDO STRUTTURATO	20	60,3x60,3	2	33,5	0,73	-	32	1072	23,36
FONDO STRUTTURATO	20	60x60 RECT	2	33,6	0,72	-	32	1075,2	23,04
COSTA TORO STRUTTURATO	20	30x60 RECT	1	8,13	0,135	-	100	813	13,5
COSTA TORO ANGOLARE STRUTTURATO	20	30x60 RECT	1	6,1	0,135	-	100	610	13,5
COSTA TORO GRIP STRUTTURATO	20	30x60 RECT	1	8,13	0,135	-	100	813	13,5
COSTA RETTA STRUTTURATO	20	30x60 RECT	1	8,13	0,135	-	100	812	13,5
COSTA RETTA ANGOLARE STRUTTURATO	20	30x60 RECT	1	6,1	0,135	-	100	610	13,5
COSTA RETTA GRIP STRUTTURATO	20	30x60 RECT	1	8,13	0,135	-	100	813	13,5
GRIGLIA STRUTTURATO	20	15x60 RECT	2	8	0,158	-	100	800	15,75
GRIGLIA ANGOLARE STRUTTURATO	20	15x60 RECT	2	7	0,158	-	100	700	15,75



# Frame

Fiordo



GLEN



RIVER



PEAK



GROOVE



GORGE

GRES PORCELLANATO A MASSA COLORATA\_COLOURED-BODY PORCELAIN STONEWARE



± 9,5 mm



45x90 cm Rect  
18"x36"



60x60 cm Rect  
24"x24"  
60,3x60,3 cm  
24"x24"



30x60 cm Rect  
12"x24"

GRES PORCELLANATO A MASSA COLORATA\_COLOURED-BODY PORCELAIN STONEWARE **20 mm**



± 20 mm



45x90 cm Rect  
18"x36"



60x60 cm Rect  
24"x24"  
60,3x60,3 cm  
24"x24"



RIVESTIMENTO / WALL Glen Naturale 30x60 cm Rect - 12"x24" \_Mosaico 36 pezzi Glen Naturale 30x30 cm Rect - 12"x12"  
 PAVIMENTO / FLOOR Glen Naturale 60x60 cm Rect - 24"x24"



RIVESTIMENTO / WALL Muretto Glen Naturale 30x60 cm Rect - 12"x24"  
 PAVIMENTO / FLOOR Groove Naturale 45x90 cm Rect - 18"x36"



PAVIMENTO / FLOOR Gorge Naturale 60x60 cm Rect - 24"x24"



RIVESTIMENTO / WALL Muretto River Naturale 30x60 cm Rect - 12"x24"  
 PAVIMENTO / FLOOR River Naturale 45x90 cm Rect - 18"x36"

# Frame

GLEN



RIVER



PEAK



GROOVE



GORGE



# Frame

## GRES PORCELLANATO A MASSA COLORATA\_COLOURED-BODY PORCELAIN STONWARE



45x90 cm Rect - 18"x36"

Glen NATURALE	FGHFM0G
River NATURALE	FGHFM3G
Peak NATURALE	FGHFM2G
Groove NATURALE	FGHFM1G
Gorge NATURALE	FGHFM4



60x60 cm Rect - 24"x24"

Glen NATURALE	FGWFM0
River NATURALE	FGWFM3
Peak NATURALE	FGWFM2
Groove NATURALE	FGWFM1
Gorge NATURALE	FGWFM4
Glen STRUTTURATO	FGWFM05
River STRUTTURATO	FGWFM35
Peak STRUTTURATO	FGWFM25
Groove STRUTTURATO	FGWFM15
Gorge STRUTTURATO	FGWFM45

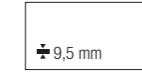

30x60 cm Rect - 12"x24"

Glen NATURALE	FG-FMR0
River NATURALE	FG-FMR3
Peak NATURALE	FG-FMR2
Groove NATURALE	FG-FMR1
Gorge NATURALE	FG-FMR4
Glen STRUTTURATO	FG-FM05
River STRUTTURATO	FG-FM35
Peak STRUTTURATO	FG-FM25
Groove STRUTTURATO	FG-FM15
Gorge STRUTTURATO	FG-FM45

60,3x60,3 cm - 24"x24"

Glen NATURALE	FGWFM00
River NATURALE	FGWFM30
Peak NATURALE	FGWFM20
Groove NATURALE	FGWFM10

## GRES PORCELLANATO A MASSA COLORATA\_COLOURED-BODY PORCELAIN STONWARE **20 mm**

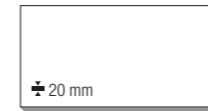

45x90 cm Rect - 18"x36"

Glen STRUTTURATO	FGHFM60
River STRUTTURATO	FGHFM63
Peak STRUTTURATO	FGHFM62
Groove STRUTTURATO	FGHFM61
Gorge STRUTTURATO	FGHFM64



60x60 cm Rect - 24"x24"

Glen STRUTTURATO	FGWFM60
River STRUTTURATO	FGWFM63
Peak STRUTTURATO	FGWFM62
Groove STRUTTURATO	FGWFM61
Gorge STRUTTURATO	FGWFM64

60,3x60,3 cm - 24"x24"

Glen STRUTTURATO	FGWFM50
River STRUTTURATO	FGWFM53
Peak STRUTTURATO	FGWFM52
Groove STRUTTURATO	FGWFM51

DESTINAZIONI D'USO\_INTENDED USE: NATURALE STRUTTURATO

### DATI TECNICI\_TECHNICAL DATA:

GRES PORCELLANATO A MASSA COLORATA COLOURED-BODY PORCELAIN STONWARE		GRES PORCELLANATO A MASSA COLORATA COLOURED-BODY PORCELAIN STONWARE	
+	9,5 mm	+	20 mm
DIN 51130:	<b>R10</b> Naturale <b>R11</b> Strutturato	DIN 51130:	<b>R11</b> Strutturato
DIN 51097:	<b>B (A+B)</b> Naturale <b>C (A+B+C)</b> Strutturato	DIN 51097:	<b>C (A+B+C)</b> Strutturato
BCR TORTUS:	$\mu > 0,40$ Naturale - Strutturato	BCR TORTUS:	$\mu > 0,40$ Strutturato
ANSI A326.3:	<b>DCOF <math>\geq 0,42</math></b> Naturale - Strutturato	ANSI A326.3:	<b>DCOF <math>\geq 0,42</math></b> Strutturato
AS/NZS 4586:	<b>P3</b> Naturale <b>P4</b> Strutturato	AS/NZS 4586:	<b>P4</b> Strutturato
BS 7976-2:	<b>PTV 36+WET (SI.96)</b> Naturale <b>PTV 36+WET (SI.96 - SI.55)</b> Strutturato	BS 7976-2:	<b>PTV 36+WET (SI.96 - SI.55)</b> Strutturato
	ANSI A137.1: <b>V2</b> Naturale - Strutturato		ANSI A137.1: <b>V2</b> Strutturato



# Frame

## DECORI\_DECORS

GRES PORCELLANATO A MASSA COLORATA\_COLOURED-BODY PORCELAIN STONWARE

### GLEN



**MURETTO NATURALE**  
30x60 cm Rect - 12"x24"  
± 9,5 mm  
FG-FMM0

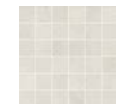

**MOSAICO 36 PEZZI NATURALE**  
30x30 cm Rect - 12"x12"  
± 9,5 mm  
PGZFM00

### RIVER



**MURETTO NATURALE**  
30x60 cm Rect - 12"x24"  
± 9,5 mm  
FG-FMM3



**MOSAICO 36 PEZZI NATURALE**  
30x30 cm Rect - 12"x12"  
± 9,5 mm  
PGZFM30

### PEAK



**MURETTO NATURALE**  
30x60 cm Rect - 12"x24"  
± 9,5 mm  
FG-FMM2



**MOSAICO 36 PEZZI NATURALE**  
30x30 cm Rect - 12"x12"  
± 9,5 mm  
PGZFM20

### GROOVE



**MURETTO NATURALE**  
30x60 cm Rect - 12"x24"  
± 9,5 mm  
FG-FMM1



**MOSAICO 36 PEZZI NATURALE**  
30x30 cm Rect - 12"x12"  
± 9,5 mm  
PGZFM10

## PEZZI SPECIALI\_TRIM PIECES

GRES PORCELLANATO A MASSA COLORATA\_COLOURED-BODY PORCELAIN STONWARE

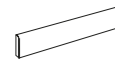

**BATTISCOPA**  
10x60 cm Rect - 4"x24"  
± 10 mm  
NATURALE



**BATTISCOPA**  
10x60,3 cm - 4"x24"  
± 10 mm  
NATURALE

	GLEN	RIVER	PEAK	GROOVE	GORGE
BATTISCOPA 10x60 cm Rect - 4"x24" ± 10 mm NATURALE	FGRFM00	FGRFM00	FGRFM00	FGRFM00	-
BATTISCOPA 10x60,3 cm - 4"x24" ± 10 mm NATURALE	FGRFM00	FGRFM00	FGRFM00	FGRFM00	-
BATTISCOPA 10x60 cm Rect - 4"x24" ± 10 mm NATURALE	FGRFM00	FGRFM00	FGRFM00	FGRFM00	-
BATTISCOPA 10x60,3 cm - 4"x24" ± 10 mm NATURALE	FGRFM00	FGRFM00	FGRFM00	FGRFM00	-
BATTISCOPA 10x60 cm Rect - 4"x24" ± 10 mm NATURALE	FGRFM00	FGRFM00	FGRFM00	FGRFM00	-
BATTISCOPA 10x60,3 cm - 4"x24" ± 10 mm NATURALE	FGRFM00	FGRFM00	FGRFM00	FGRFM00	-

## IMBALLAGGI E PESI\_PACKINGS AND WEIGHTS

DESCRIZIONE Description	± mm	FORMATI Sizes	SCATOLA_Box				PALLET			
			📦	📦 KG	📦 M <sup>2</sup>	📦 ML	📦	📦 KG	📦 M <sup>2</sup>	
FONDO NATURALE	9,5	45x90 <sup>RECT</sup>	3	25,2	1,215	-	36	907,2	43,74	
FONDO NATURALE / STRUTTURATO	9,5	60x60 <sup>RECT</sup>	4	31,8	1,44	-	32	1018	46,1	
FONDO NATURALE	9,5	60,3x60,3	4	31,8	1,45	-	32	1018	46,5	
FONDO NATURALE / STRUTTURATO	9,5	30x60 <sup>RECT</sup>	8	31,8	1,44	-	32	1018	46,1	
MURETTO NATURALE	9,5	30x60 <sup>RECT</sup>	4	15,7	0,72	-	30	471	21,6	
MOSAICO 36 PEZZI NATURALE	9,5	30x30 <sup>RECT</sup>	5	10,1	0,45	-	60	604	27	
BATTISCOPA NATURALE	10	10x60 <sup>RECT</sup>	12	15,48	0,72	7,2	60	928,8	43,2	
BATTISCOPA NATURALE	10	10x60,3	16	20	0,9648	9,648	48	960	46,31	
FONDO STRUTTURATO	20	60x60 <sup>RECT</sup>	2	33	0,72	-	32	1056	23,04	
FONDO STRUTTURATO	20	60,3x60,3	2	33,3	0,73	-	32	1065,6	23,27	
FONDO STRUTTURATO	20	45x90 <sup>RECT</sup>	2	36,23	0,81	-	24	869,52	19,44	

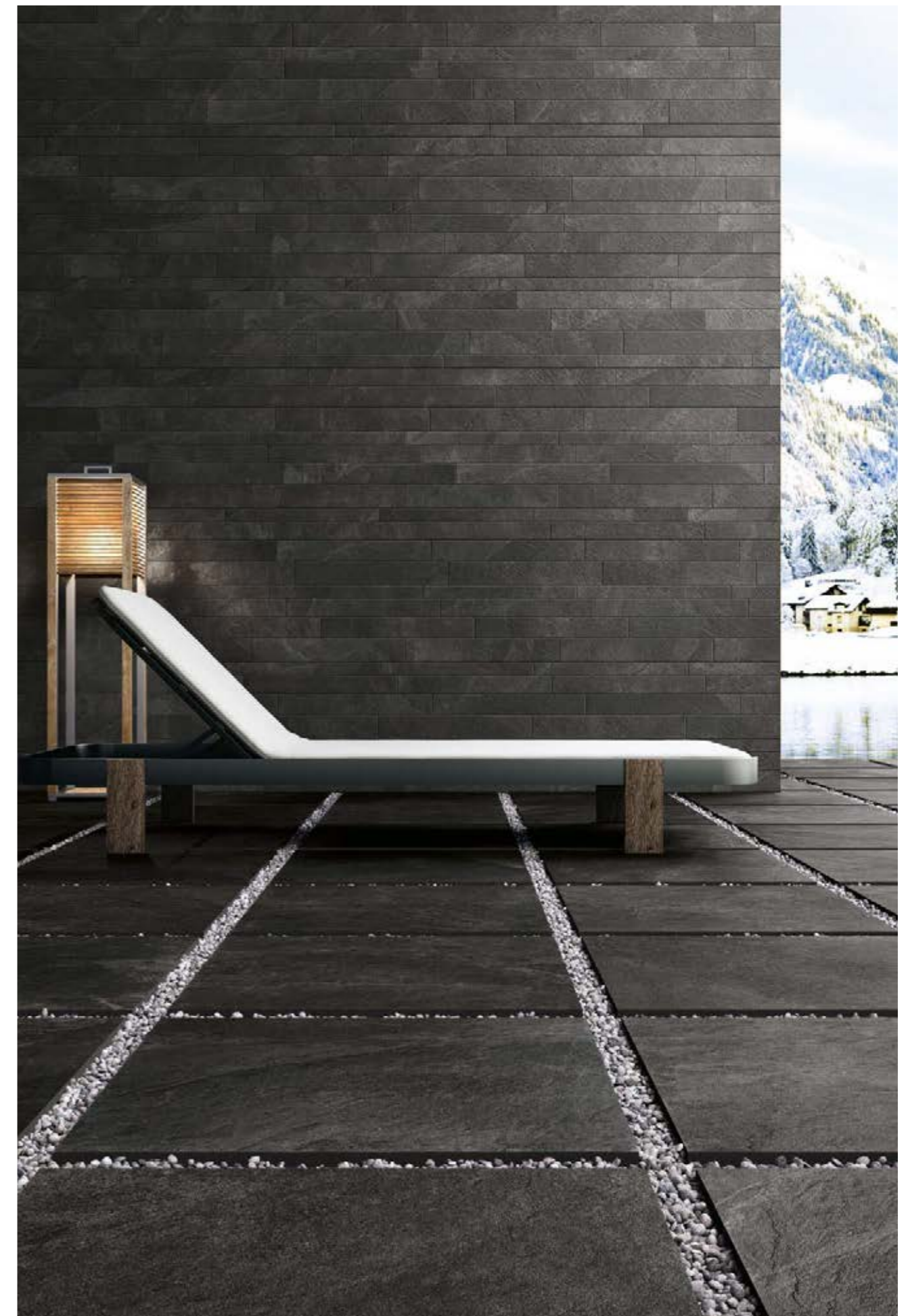

RIVESTIMENTO / WALL Muretto Groove Naturale 30x60 cm Rect - 12"x24"  
PAVIMENTO / FLOOR Groove Strutturato 60x60 cm Rect - 24"x24" 20 mm



# Horizon



SUNRISE



SUNSET



SKY



CLOUD



STORM

GRES PORCELLANATO A MASSA COLORATA\_COLOURED-BODY PORCELAIN STONEWARE



± 9,5 mm



60x120 cm Rect  
24"x48"



60x60 cm Rect  
24"x24"  
60,3x60,3 cm  
24"x24"



30x60 cm Rect  
12"x24"

GRES PORCELLANATO A MASSA COLORATA\_COLOURED-BODY PORCELAIN STONEWARE **20 mm**



± 20 mm



60x120 cm Rect  
24"x48"



RIVESTIMENTO / WALL Wall 3D Sunset Naturale 30x58 cm Rect - 12"x23"  
PAVIMENTO / FLOOR Storm Naturale 60x120 cm Rect - 24"x48"



RIVESTIMENTO / WALL Hexagon Sunrise Naturale 30x30 cm Rect - 12"x12"  
PAVIMENTO / FLOOR Sunset Naturale 60x120 cm Rect - 24"x48"



PAVIMENTO / FLOOR Sky Naturale 60x60 cm Rect - 24"x24"



RIVESTIMENTO / WALL Storm Naturale 30x60 cm Rect - 12"x24"  
PAVIMENTO / FLOOR Sunrise Strutturato 60x120 cm Rect - 24"x48" 20 mm\_Sunrise Strutturato 60,3x60,3 cm - 24"x24"

# Horizon

**PROTECT**  
ANTIBATTERICO - ANTIMICROBIAL

## SUNRISE



## SUNSET



## SKY

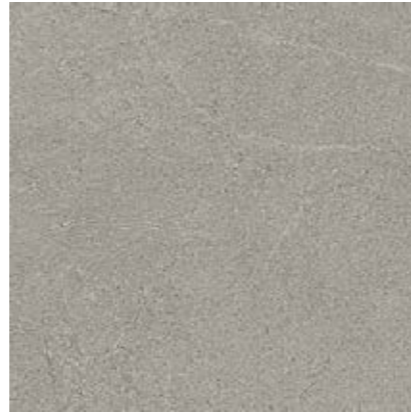

## CLOUD

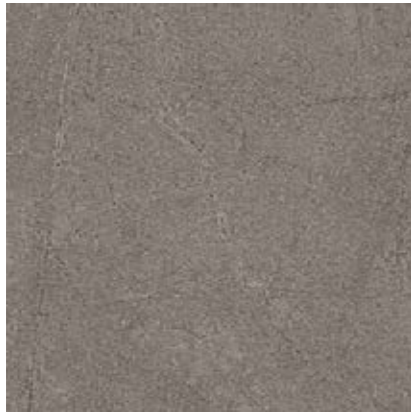

## STORM

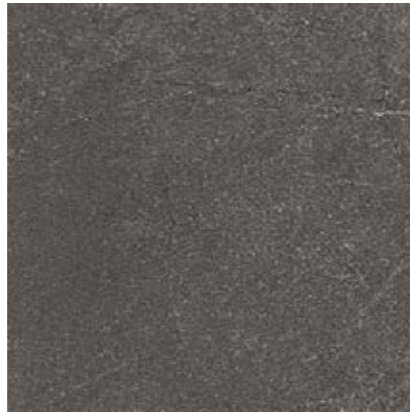

# Horizon

**GRES PORCELLANATO A MASSA COLORATA**\_COLOURED-BODY PORCELAIN STONEWARE



60x120 cm Rect - 24"x48"

Sunrise NATURALE PGXHN303  
Sunset NATURALE PGXHN403  
Sky NATURALE PGXHN103  
Cloud NATURALE PGXHN003  
Storm NATURALE PGXHN203

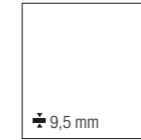

60x60 cm Rect - 24"x24"

Sunrise NATURALE PGWHNR3  
Sunset NATURALE PGWHNR4  
Sky NATURALE PGWHNR1  
Cloud NATURALE PGWHNR0  
Storm NATURALE PGWHNR2  
Sunrise STRUTTURATO\* PGWHNG3  
Sunset STRUTTURATO\* PGWHNG4  
Cloud STRUTTURATO\* PGWHNG0  
Storm STRUTTURATO\* PGWHNG2



60,3x60,3 cm Rect - 24"x24"

Sunrise STRUTTURATO\* PGWHNB3  
Sunset STRUTTURATO\* PGWHNB4  
Cloud STRUTTURATO\* PGWHNB0  
Storm STRUTTURATO\* PGWHNB2



30x60 cm Rect - 12"x24"

Sunrise NATURALE PG-HNR3  
Sunset NATURALE PG-HNR4  
Sky NATURALE PG-HNR1  
Cloud NATURALE PG-HNR0  
Storm NATURALE PG-HNR2  
Sunrise STRUTTURATO\* PG-HNG3  
Sunset STRUTTURATO\* PG-HNG4  
Cloud STRUTTURATO\* PG-HNG0  
Storm STRUTTURATO\* PG-HNG2

**GRES PORCELLANATO A MASSA COLORATA**\_COLOURED-BODY PORCELAIN STONEWARE **20 mm**



60x120 cm Rect - 24"x48"

Sunrise STRUTTURATO\* PGXHN63  
Sunset STRUTTURATO\* PGXHN64  
Cloud STRUTTURATO\* PGXHN60  
Storm STRUTTURATO\* PGXHN62

DESTINAZIONI D'USO\_INTENDED USE: NATURALE STRUTTURATO

DATI TECNICI\_TECHNICAL DATA:

GRES PORCELLANATO A MASSA COLORATA COLOURED-BODY PORCELAIN STONEWARE	GRES PORCELLANATO A MASSA COLORATA COLOURED-BODY PORCELAIN STONEWARE
9,5 mm	20 mm
DIN 51130: <b>R10</b> Naturale <b>R11</b> Strutturato DIN 51097: <b>C (A+B+C)</b> Strutturato BCR TORTUS: $\mu > 0,40$ Naturale - Strutturato ANSI A326.3: <b>DCOF <math>\geq 0,42</math></b> Naturale - Strutturato	DIN 51130: <b>R11</b> Strutturato DIN 51097: <b>C (A+B+C)</b> Strutturato BCR TORTUS: $\mu > 0,40$ Strutturato ANSI A326.3: <b>DCOF <math>\geq 0,42</math></b> Strutturato
ANSI A137.1: <b>V2</b> Naturale - Strutturato	ANSI A137.1: <b>V2</b> Strutturato
<b>PROTECT</b> ANTIBATTERICO - ANTIMICROBIAL Naturale	

\* Protezione antibatterica non presente\_No antimicrobial protection\_Der Antibakterielle Schutz nicht vorhanden\_Protection antibactérienne pas présente

# Horizon

## DECORI\_DECORS

GRES PORCELLANATO A MASSA COLORATA\_COLOURED-BODY PORCELAIN STONWARE

SUNRISE	SUNSET	SKY	CLOUD	STORM
<b>WALL 3D NATURALE</b> 30x58 cm Rect - 12"x23" ± 9,5 mm PGZHNW3	<b>WALL 3D NATURALE</b> 30x58 cm Rect - 12"x23" ± 9,5 mm PGZHNW4	<b>WALL 3D NATURALE</b> 30x58 cm Rect - 12"x23" ± 9,5 mm PGZHNW1	<b>WALL 3D NATURALE</b> 30x58 cm Rect - 12"x23" ± 9,5 mm PGZHNW0	<b>WALL 3D NATURALE</b> 30x58 cm Rect - 12"x23" ± 9,5 mm PGZHNW2
<b>MOSAICO 36 PEZZI NATURALE</b> 30x30 cm Rect - 12"x12" ± 9,5 mm PGZHNM3	<b>MOSAICO 36 PEZZI NATURALE</b> 30x30 cm Rect - 12"x12" ± 9,5 mm PGZHNM4	<b>MOSAICO 36 PEZZI NATURALE</b> 30x30 cm Rect - 12"x12" ± 9,5 mm PGZHNM1	<b>MOSAICO 36 PEZZI NATURALE</b> 30x30 cm Rect - 12"x12" ± 9,5 mm PGZHNM0	<b>MOSAICO 36 PEZZI NATURALE</b> 30x30 cm Rect - 12"x12" ± 9,5 mm PGZHNM2
<b>RAILS NATURALE</b> 30x30 cm Rect - 12"x12" ± 9,5 mm PGZHNR3	<b>RAILS NATURALE</b> 30x30 cm Rect - 12"x12" ± 9,5 mm PGZHNR4	<b>RAILS NATURALE</b> 30x30 cm Rect - 12"x12" ± 9,5 mm PGZHNR1	<b>RAILS NATURALE</b> 30x30 cm Rect - 12"x12" ± 9,5 mm PGZHNR0	<b>RAILS NATURALE</b> 30x30 cm Rect - 12"x12" ± 9,5 mm PGZHNR2
<b>HEXAGON NATURALE</b> 30x30 cm Rect - 12"x12" ± 9,5 mm PGZHNH3	<b>HEXAGON NATURALE</b> 30x30 cm Rect - 12"x12" ± 9,5 mm PGZHNH4	<b>HEXAGON NATURALE</b> 30x30 cm Rect - 12"x12" ± 9,5 mm PGZHNH1	<b>HEXAGON NATURALE</b> 30x30 cm Rect - 12"x12" ± 9,5 mm PGZHNH0	<b>HEXAGON NATURALE</b> 30x30 cm Rect - 12"x12" ± 9,5 mm PGZHNH2

**WALL 3D:**  
Posare solo a parete\_Recommended only for wall applications\_Nur an der Wand verlegen\_Recommandé seulement pour les revêtements

## PEZZI SPECIALI\_TRIM PIECES

GRES PORCELLANATO A MASSA COLORATA\_COLOURED-BODY PORCELAIN STONWARE

	BATTISCOPA	ANGOLO GRADONE A COSTA RETTA	GRADONE A COSTA RETTA	BATTISCOPA SCALA DX (kit 2 pezzi)	BATTISCOPA SCALA SX (kit 2 pezzi)	ELEMENTO "L"
	<b>10x60 cm Rect - 4"x24"</b> ± 10 mm NATURALE	<b>34x34 cm - 13<sup>3/8</sup>"x13<sup>3/8</sup>"</b> ± 9,5 mm NATURALE	<b>30x34 cm Rect - 12"x13<sup>3/8</sup>"</b> ± 9,5 mm NATURALE	<b>10x45 cm - 4"x18"</b> ± 10 mm NATURALE	<b>10x45 cm - 4"x18"</b> ± 10 mm NATURALE	<b>15x30x4 cm - 6"x12"x1<sup>9/16</sup>"</b> ± 9 mm STRUTTURATO*
SUNRISE	PGRHN30	PGEHN31	PGEHN30	PGZHN3D	PGZHN3S	PGZHN3
SUNSET	PGRHN40	PGEHN41	PGEHN40	PGZHN4D	PGZHN4S	PGZHN4
SKY	PGRHN10	PGEHN11	PGEHN10	PGZHN1D	PGZHN1S	-
CLOUD	PGRHN00	PGEHN01	PGEHN00	PGZHN0D	PGZHN0S	PGZHN0
STORM	PGRHN20	PGEHN21	PGEHN20	PGZHN2D	PGZHN2S	PGZHN2

\* Protezione antibatterica non presente\_No antimicrobial protection\_Der Antibakterielle Schutz nicht vorhanden\_Protection antibactérienne pas présente

# Horizon

## PEZZI SPECIALI\_TRIM PIECES

GRES PORCELLANATO A MASSA COLORATA\_COLOURED-BODY PORCELAIN STONWARE **20 mm**

	COSTA TORO ANGOLARE DX	COSTA TORO ANGOLARE SX	COSTA TORO	COSTA TORO GRIP	COSTA RETTA ANGOLARE DX	COSTA RETTA ANGOLARE SX
	<b>30x60 cm Rect - 12"x24"</b> STRUTTURATO*	<b>30x60 cm Rect - 12"x24"</b> STRUTTURATO*	<b>30x60 cm Rect - 12"x24"</b> STRUTTURATO*	<b>30x60 cm Rect - 12"x24"</b> STRUTTURATO*	<b>30x60 cm Rect - 12"x24"</b> STRUTTURATO*	<b>30x60 cm Rect - 12"x24"</b> STRUTTURATO*
SUNRISE	PGDHNK8	PGDHNK9	PGDHNK3	PGDHNJ3	PGDHNK8	PGDHNK9
SUNSET	PGDHNK6	PGDHNK7	PGDHNK4	PGDHNJ4	PGDHNK6	PGDHNK7
CLOUD	PGDHNK0	PGDHNK1	PGDHNK0	PGDHNJ0	PGDHNK0	PGDHNK1
STORM	PGDHNK4	PGDHNK5	PGDHNK2	PGDHNJ2	PGDHNK4	PGDHNK5
	<b>30x60 cm Rect - 12"x24"</b> STRUTTURATO*	<b>30x60 cm Rect - 12"x24"</b> STRUTTURATO*	<b>15x60 cm Rect - 6"x24"</b> STRUTTURATO*	<b>15x60 cm Rect - 6"x24"</b> STRUTTURATO*	<b>15x60 cm Rect - 6"x24"</b> STRUTTURATO*	
SUNRISE	PGDHNK3	PGDHNK3	PGDHNK3	PGDHNK3	PGDHNK3	
SUNSET	PGDHNK4	PGDHNK4	PGDHNK4	PGDHNK4	PGDHNK4	
CLOUD	PGDHNK0	PGDHNK0	PGDHNK0	PGDHNK0	PGDHNK0	
STORM	PGDHNK2	PGDHNK2	PGDHNK2	PGDHNK2	PGDHNK2	

\* Protezione antibatterica non presente\_No antimicrobial protection\_Der Antibakterielle Schutz nicht vorhanden\_Protection antibactérienne pas présente

## IMBALLAGGI E PESI\_PACKINGS AND WEIGHTS

DESCRIZIONE Description	± mm	FORMATI Sizes	SCATOLA_Box				PALLET		
FONDO NATURALE	9,5	60x120 RECT	2	31,8	1,44	-	36	1145	51,8
FONDO NATURALE / STRUTTURATO	9,5	60x60 RECT	4	31,8	1,45	-	32	1018	46,5
FONDO NATURALE / STRUTTURATO	9,5	30x60 RECT	8	31,8	1,44	-	32	1018	46,1
FONDO STRUTTURATO	9,5	60,3x60,3	4	31,8	1,45	-	32	1018	46,5
MOSAICO 36 PEZZI NATURALE	9,5	30x30 RECT	4	7,3	0,36	-	78	571	28,1
RAILS NATURALE	9,5	30x30 RECT	6	11,8	0,54	-	60	708	32,4
WALL 3D NATURALE	9,5	30x60 RECT	4	15,7	0,7	-	24	377	16,7
EXAGON NATURALE	9,5	30x30 RECT	4	6,2	0,28	-	30	185	8,5
BATTISCOPA NATURALE	10	10x60 RECT	12	15,48	0,72	7,2	60	929	43,2
BATTISCOPA SCALA (KIT 2 PZ.) NATURALE	10	10x45	5	8,5	0,42	-	-	-	-
GRADONE A COSTA RETTA NATURALE	9,5	30x34 RECT	6	17,1	0,61	-	30	513	18,4
ANGOLO GRADONE A COSTA RETTA NATURALE	9,5	34x34	2	6,3	0,23	-	48	301	11,1
ELEMENTO "L" STRUTTURATO	9	15x30x4	8	9,6	0,36	2,4	48	461	17,28
FONDO STRUTTURATO	20	60x120 RECT	1	32,5	0,72	-	32	1040	23,04
COSTA TORO STRUTTURATO	20	30x60 RECT	1	8,125	0,135	-	100	813	13,5
COSTA TORO ANGOLARE STRUTTURATO	20	30x60 RECT	1	6,1	0,135	-	100	610	13,5
COSTA TORO GRIP STRUTTURATO	20	30x60 RECT	1	8,125	0,135	-	100	813	13,5
COSTA RETTA STRUTTURATO	20	30x60 RECT	1	8,125	0,135	-	100	813	13,5
COSTA RETTA ANGOLARE STRUTTURATO	20	30x60 RECT	1	6,1	0,135	-	100	610	13,5
COSTA RETTA GRIP STRUTTURATO	20	30x60 RECT	1	8,125	0,135	-	100	813	13,5
GRIGLIA STRUTTURATO	20	15x60 RECT	2	8	0,158	-	100	800	15,75
GRIGLIA ANGOLARE STRUTTURATO	20	15x60 RECT	2	7	0,158	-	100	700	15,75



# Petra Solis



SOMNIUM



FABULA



MIRUM

GRES PORCELLANATO A MASSA COLORATA\_COLOURED-BODY PORCELAIN STONEWARE



± 10 mm



60x60 cm Rect  
24"x24"  
60,8x60,8 cm  
24"x24"



40,4x60,8 cm  
16"x24"



40,4x40,4 cm  
16"x16"



20x40,4 cm  
8"x16"



20x20 cm  
8"x8"

GRES PORCELLANATO A MASSA COLORATA\_COLOURED-BODY PORCELAIN STONEWARE **20 mm**



± 20 mm



60x60 cm Rect  
24"x24"





PAVIMENTO / FLOOR Somnium Naturale 60,8x60,8 cm - 24"x24" \_40,4x60,8 cm - 16"x24" \_40,4x40,4 cm - 16"x16" \_20x40,4 cm - 8"x16" \_20x20 cm - 8"x8"



PAVIMENTO / FLOOR Mirium Strutturato 60x60 cm Rect - 24"x24" 20 mm

# Petra Solis

## SOMNIUM



## FABULA



## MIRUM



# Petra Solis

## GRES PORCELLANATO A MASSA COLORATA\_COLOURED-BODY PORCELAIN STONEWARE

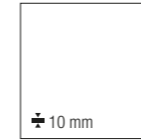

60x60 cm Rect - 24"x24"

Somnium NATURALE PGWPS11  
 Fabula NATURALE PGWPS01  
 Mirum NATURALE PGWPS31

60,8x60,8 cm - 24"x24"

Somnium NATURALE PGWPS10  
 Fabula NATURALE PGWPS00  
 Mirum NATURALE PGWPS30



40,4x60,8 cm - 16"x24"

Somnium NATURALE PGJPS10  
 Fabula NATURALE PGJPS00  
 Mirum NATURALE PGJPS30

Somnium STRUTTURATO PGJPSS1  
 Fabula STRUTTURATO PGJPSS0  
 Mirum STRUTTURATO PGJPSS3



40,4x40,4 cm - 16"x16"

Somnium NATURALE PGUPS10  
 Fabula NATURALE PGUPS00  
 Mirum NATURALE PGUPS30



20x40,4 cm - 8"x16"

Somnium NATURALE PGKPS10  
 Fabula NATURALE PGKPS00  
 Mirum NATURALE PGKPS30

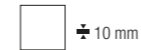

20x20 cm - 8"x8"

Somnium NATURALE PGEPS10  
 Fabula NATURALE PGEPS00  
 Mirum NATURALE PGEPS30

## GRES PORCELLANATO A MASSA COLORATA\_COLOURED-BODY PORCELAIN STONEWARE **20 mm**



60x60 cm Rect - 24"x24"

Somnium STRUTTURATO PGWPS16  
 Mirum STRUTTURATO PGWPS36

DESTINAZIONI D'USO\_INTENDED USE: NATURALE STRUTTURATO

### DATI TECNICI\_TECHNICAL DATA:

	GRES PORCELLANATO A MASSA COLORATA COLOURED-BODY PORCELAIN STONEWARE	GRES PORCELLANATO A MASSA COLORATA COLOURED-BODY PORCELAIN STONEWARE
	10 mm	20 mm
	DIN 51130: R10 Naturale R11 Strutturato	DIN 51130: R11 Strutturato
	DIN 51097: B (A+B) Naturale C (A+B+C) Strutturato	DIN 51097: C (A+B+C) Strutturato
	BCR TORTUS: $\mu > 0,40$ Naturale - Strutturato	BCR TORTUS: $\mu > 0,40$ Strutturato
	ANSI A326.3: DCOF $\geq 0,42$ Naturale - Strutturato	ANSI A326.3: DCOF $\geq 0,42$ Strutturato
	AS/NZS 4586: P4 Strutturato	AS/NZS 4586: P4 Strutturato
	BS 7976-2: PTV 36+WET (SI.96 - SI.55) Strutturato	BS 7976-2: PTV 36+WET (SI.96 - SI.55) Strutturato
	UNE ENV 12633: Classe 3 Strutturato	UNE ENV 12633: Classe 3 Strutturato
	ANSI A137.1: V3 Naturale - Strutturato	ANSI A137.1: V3 Strutturato

# Petra Solis

## SOLUZIONI DI POSA\_LAYING SOLUTIONS

GRES PORCELLANATO A MASSA COLORATA\_COLOURED-BODY PORCELAIN STONEWARE



**MODULO 1\_5 FORMATI**  
 60,8x60,8 cm = 32,33%  
 40,4x40,4 cm = 28,55%  
 40,4x60,8 cm = 21,49%  
 20x40,4 cm = 14,13%  
 20x20 cm = 3,5%

Somnium PGZPSS1  
 Fabula PGZPSF1  
 Mirum PGZPSM1

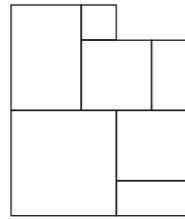

**MODULO 2\_4 FORMATI**  
 40,4x40,4 cm = 44,54%  
 40,4x60,8 cm = 33,52%  
 20x40,4 cm = 11,02%  
 20x20 cm = 10,92%

Somnium PGZPSS2  
 Fabula PGZPSF2  
 Mirum PGZPSM2

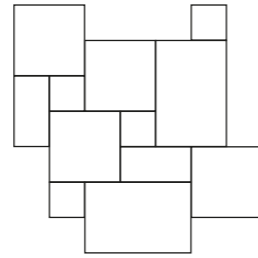

**MODULO 3\_3 FORMATI**  
 40,4x40,4 cm = 50%  
 40,4x60,8 cm = 37,62%  
 20x40,4 cm = 12,38%

Somnium PGZPSS3  
 Fabula PGZPSF3  
 Mirum PGZPSM3

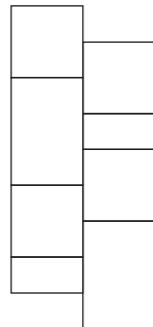

**MODULO 4\_3 FORMATI**  
 60,8x60,8 cm = 53,04%  
 40,4x60,8 cm = 35,25%  
 40,4x40,4 cm = 11,71%

Somnium PGZPSS4  
 Fabula PGZPSF4  
 Mirum PGZPSM4

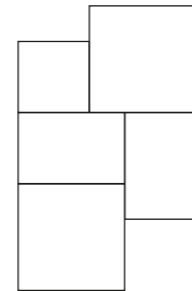

Esempio di sviluppo su superficie 4x4 mt\_Example of extension on 4x4 mt surface\_4x4 mt Entwicklungsbeispiel\_Exemple de développement sur une surface de 4x4 M²

# Petra Solis

## PEZZI SPECIALI\_TRIM PIECES

GRES PORCELLANATO A MASSA COLORATA\_COLOURED-BODY PORCELAIN STONEWARE

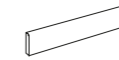

**BATTISCOPA**  
 10x60 cm Rect - 4"x24"  
 ± 10 mm  
 NATURALE

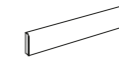

**BATTISCOPA**  
 10x60,3 cm - 4"x24"  
 ± 10 mm  
 NATURALE

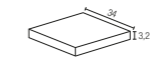

**ANGOLO GRADONE A COSTA RETTA**  
 34x34 cm - 13<sup>3/8</sup>"x13<sup>3/8</sup>"  
 ± 10 mm  
 NATURALE

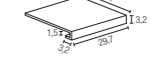

**GRADONE A COSTA RETTA**  
 30x34 cm - 12"x13<sup>3/8</sup>"  
 ± 10 mm  
 NATURALE

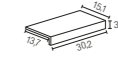

**ELEMENTO "L"**  
 15x30x4 cm - 6"x12"x1<sup>3/8</sup>"  
 ± 9 mm  
 STRUTTURATO

SOMNIUM	PGRPS11	PGRPS10	PGEPS11	PGEPS10	PGZPSA1
FABULA	PGRPS01	PGRPS00	PGEPS01	PGEPS00	PGZPSA0
MIRUM	PGRPS31	PGRPS30	PGEPS31	PGEPS30	PGZPSA3

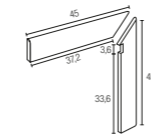

**BATTISCOPA SCALA DX** (kit 2 pezzi)  
 10x45 cm - 4"x18"  
 ± 10 mm  
 NATURALE

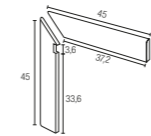

**BATTISCOPA SCALA SX** (kit 2 pezzi)  
 10x45 cm - 4"x18"  
 ± 10 mm  
 NATURALE

SOMNIUM	PGZPS1D	PGZPS1S
FABULA	PGZPS0D	PGZPS0S
MIRUM	PGZPS3D	PGZPS3S

GRES PORCELLANATO A MASSA COLORATA\_COLOURED-BODY PORCELAIN STONEWARE **20 mm**



**COSTA TORO ANGOLARE DX**  
 30x60 cm Rect - 12"x24"  
 STRUTTURATO



**COSTA TORO ANGOLARE SX**  
 30x60 cm Rect - 12"x24"  
 STRUTTURATO



**COSTA TORO**  
 30x60 cm Rect - 12"x24"  
 STRUTTURATO

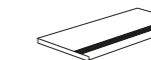

**COSTA TORO GRIP**  
 30x60 cm Rect - 12"x24"  
 STRUTTURATO

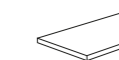

**COSTA RETTA ANGOLARE DX**  
 30x60 cm Rect - 12"x24"  
 STRUTTURATO

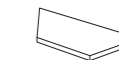

**COSTA RETTA ANGOLARE SX**  
 30x60 cm Rect - 12"x24"  
 STRUTTURATO

SOMNIUM	PGDPSK1	PGDPSK2	PGDPSF1	PGDPSJ1	PGDPSD1	PGDPSD2
MIRUM	PGDPSK3	PGDPSK4	PGDPSF3	PGDPSJ3	PGDPSD3	PGDPSD4



**COSTA RETTA**  
 30x60 cm Rect - 12"x24"  
 STRUTTURATO

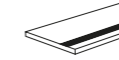

**COSTA RETTA GRIP**  
 30x60 cm Rect - 12"x24"  
 STRUTTURATO

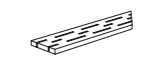

**GRIGLIA ANGOLARE DX**  
 15x60 cm Rect - 6"x24"  
 STRUTTURATO



**GRIGLIA ANGOLARE SX**  
 15x60 cm Rect - 6"x24"  
 STRUTTURATO

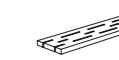

**GRIGLIA**  
 15x60 cm Rect - 6"x24"  
 STRUTTURATO

SOMNIUM	PGDPSK1	PGDPSG1	PGDPSA1	PGDPSA2	PGDPSZ1
MIRUM	PGDPSK3	PGDPSG3	PGDPSA3	PGDPSA4	PGDPSZ3

## IMBALLAGGI E PESI\_PACKINGS AND WEIGHTS

DESCRIZIONE Description	± mm	FORMATI Sizes	SCATOLA_Box				PALLET			
			📦	KG	M²	ML	📦	KG	M²	
FONDO NATURALE	10	60x60 RECT	4	32,3	1,44	-	32	1034	46,08	
FONDO NATURALE	10	60,8x60,8	4	32,8	1,48	-	32	1050	47,32	
FONDO NATURALE / STRUTTURATO	10	40,4x60,8	5	28,8	1,23	-	48	1382	58,95	
FONDO NATURALE	10	40,4x40,4	7	26,8	1,14	-	52	1394	59,41	
FONDO NATURALE	10	20x40,4	12	22,8	0,97	-	54	1231	52,36	
FONDO NATURALE	10	20x20	27	25,4	1,08	-	45	1143	48,6	
BATTISCOPA NATURALE	10	10x60 RECT	12	15,48	0,72	7,20	60	929	43,2	
BATTISCOPA NATURALE	10	10x60,3	16	20	0,9648	9,648	48	960	46,31	
BATTISCOPA SCALA NATURALE	10	10x45	5	8,5	0,4	-	-	-	-	
GRADONE A COSTA RETTA NATURALE	10	30x34	6	18	0,61	-	30	540	18,36	
ANGOLO GRADONE A COSTA RETTA NATURALE	10	34x34	2	6,6	0,23	-	48	317	11,1	
ELEMENTO "L" STRUTTURATO	9	15x30x4	8	9,6	0,36	2,40	48	461	17,28	
FONDO STRUTTURATO	20	60x60 RECT	2	33	0,72	-	32	1056	23,04	
COSTA TORO STRUTTURATO	20	30x60 RECT	1	8,13	0,135	-	100	813	13,5	
COSTA TORO GRIP STRUTTURATO	20	30x60 RECT	1	8,13	0,135	-	100	813	13,5	
COSTA TORO ANGOLARE STRUTTURATO	20	30x60 RECT	1	6,1	0,135	-	100	610	13,5	
COSTA RETTA STRUTTURATO	20	30x60 RECT	1	8,13	0,135	-	100	813	13,5	
COSTA RETTA GRIP STRUTTURATO	20	30x60 RECT	1	8,13	0,135	-	100	813	13,5	
COSTA RETTA ANGOLARE STRUTTURATO	20	30x60 RECT	1	6,1	0,135	-	100	610	13,5	
GRIGLIA STRUTTURATO	20	15x60 RECT	2	8	0,158	-	100	800	15,75	
GRIGLIA ANGOLARE STRUTTURATO	20	15x60 RECT	2	7	0,158	-	100	700	15,75	



# Pierre des Rêves



REVEILLE



NUAGE



AURORE



CHARME



OUBLI

GRES PORCELLANATO A MASSA COLORATA\_COLOURED-BODY PORCELAIN STONEWARE



± 9,5 mm  
± 12 mm



90x90 cm Rect  
36"x36"

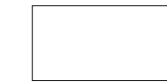

60x120 cm Rect  
24"x48"



60x60 cm Rect  
24"x24"



30x60 cm Rect  
12"x24"



20x40,4 cm  
8"x16"



20x30,2 cm  
8"x12"



20x20 cm  
8"x8"

GRES PORCELLANATO A MASSA COLORATA\_COLOURED-BODY PORCELAIN STONEWARE **20 mm**



± 20 mm



60x120 cm Rect  
24"x48"



RIVESTIMENTO / WALL Muretto Charme Naturele 30x60 cm Rect - 12"x24"  
PAVIMENTO / FLOOR Charme Naturele 90x90 cm Rect - 36"x36"\_Charme Strutturato 60x120 cm Rect - 24"x48" 20 mm



PAVIMENTO / FLOOR Chevron Nuage Naturele 29,2x39 cm Rect - 11<sup>1</sup>/<sub>2</sub>"x15<sup>3</sup>/<sub>8</sub>"



RIVESTIMENTO / WALL Muretto Oubli Naturele 30x60 cm Rect - 12"x24"  
PAVIMENTO / FLOOR Oubli Naturele 60x120 cm Rect - 24"x48"\_Oubli Ext 60x60 cm Rect - 24"x24"



RIVESTIMENTO / WALL Reveille Naturelle 60x120 cm Rect - 24"x48" \_Mosaico 16 pezzi Oubli Naturelle 30x30 cm Rect - 12"x12"  
PAVIMENTO / FLOOR Reveille Naturelle 60x60 cm Rect - 24"x24"





PAVIMENTO / FLOOR Aurore Structurato 20x20 cm - 8"x8" \_20x30,2 cm - 8"x12" \_20x40,4 cm - 8"x16"



PAVIMENTO / FLOOR Nuage Structurato 20x20 cm - 8"x8" \_20x30,2 cm - 8"x12" \_20x40,4 cm - 8"x16"

# Pierre des Rêves

**PROTECT**  
ANTIBATTERICO - ANTIMICROBIAL

## REVEILLE



## NUAGE



## AUORE



## CHARME



## OUBLI



# Pierre des Rêves

## GRES PORCELLANATO A MASSA COLORATA\_COLOURED-BODY PORCELAIN STONEWARE



90x90 cm Rect - 36"x36"  
Reveille NATURALE PGGP840G  
Nuage NATURALE PGGP810G  
Aurore NATURALE PGGP800G  
Charme NATURALE PGGP830G  
Oubli NATURALE PGGP820G

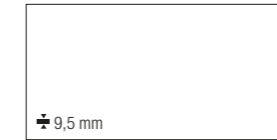

60x120 cm Rect - 24"x48"  
Reveille NATURALE PGXP890  
Nuage NATURALE PGXP860  
Aurore NATURALE PGXP850  
Charme NATURALE PGXP880  
Oubli NATURALE PGXP870



60x60 cm Rect - 24"x24"  
Reveille NATURALE PGWP890  
Nuage NATURALE PGWP860  
Aurore NATURALE PGWP850  
Charme NATURALE PGWP880  
Oubli NATURALE PGWP870  
Reveille EXT\* PGWP840  
Nuage EXT\* PGWP810  
Aurore EXT\* PGWP800  
Charme EXT\* PGWP830  
Oubli EXT\* PGWP820

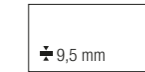

30x60 cm Rect - 12"x24"  
Reveille NATURALE PG-P890  
Nuage NATURALE PG-P860  
Aurore NATURALE PG-P850  
Charme NATURALE PG-P880  
Oubli NATURALE PG-P870  
Reveille EXT\* PG-P840  
Nuage EXT\* PG-P810  
Aurore EXT\* PG-P800  
Charme EXT\* PG-P830  
Oubli EXT\* PG-P820



20x40,4 cm - 8"x16"  
Nuage STRUTTURATO\* PGKP810  
Aurore STRUTTURATO\* PGKP800  
Oubli STRUTTURATO\* PGKP820



20x30,2 cm - 8"x12"  
Nuage STRUTTURATO\* PGBP810  
Aurore STRUTTURATO\* PGBP800  
Oubli STRUTTURATO\* PGBP820



20x20 cm - 8"x8"  
Nuage STRUTTURATO\* PGEP810  
Aurore STRUTTURATO\* PGEP800  
Oubli STRUTTURATO\* PGEP820

## GRES PORCELLANATO A MASSA COLORATA\_COLOURED-BODY PORCELAIN STONEWARE 20 mm

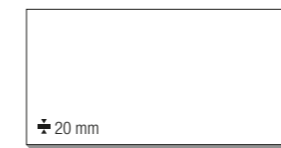

60x120 cm Rect - 24"x48"  
Reveille STRUTTURATO\* PGXP840  
Nuage STRUTTURATO\* PGXP810  
Aurore STRUTTURATO\* PGXP800  
Charme STRUTTURATO\* PGXP830  
Oubli STRUTTURATO\* PGXP820

DESTINAZIONI D'USO\_INTENDED USE: NATURALE STRUTTURATO / EXT

### DATI TECNICI\_TECHNICAL DATA:

GRES PORCELLANATO A MASSA COLORATA COLOURED-BODY PORCELAIN STONEWARE		GRES PORCELLANATO A MASSA COLORATA COLOURED-BODY PORCELAIN STONEWARE	
+	9,5 / 12 mm		20 mm
DIN 51130:	R10 Naturale R11 Ext R12 Strutturato	DIN 51130:	R12 Strutturato
DIN 51097:	A Naturale C (A+B+C) Ext - Strutturato	DIN 51097:	C (A+B+C) Strutturato
BCR TORTUS:	$\mu > 0,40$ Naturale - Ext - Strutturato	BCR TORTUS:	$\mu > 0,40$ Strutturato
ANSI A326.3:	DCOF $\geq 0,42$ Naturale - Ext - Strutturato	ANSI A326.3:	DCOF $\geq 0,42$ Strutturato
AS/NZS 4586:	P4 Ext - Strutturato	AS/NZS 4586:	P4 Strutturato
BS 7976-2:	PTV 36+WET (SI.96 - SI.55) Ext - Strutturato	BS 7976-2:	PTV 36+WET (SI.96 - SI.55) Strutturato
	ANSI A137.1: V4 Naturale - Ext - Strutturato		ANSI A137.1: V4 Strutturato

**PROTECT**  
ANTIBATTERICO - ANTIMICROBIAL Naturale

## SOLUZIONI DI POSA OUTDOOR\_OUTDOOR LAYING SOLUTIONS 12 mm

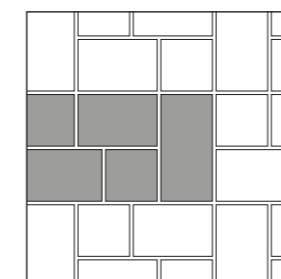

20x40,4 (28,69%) - 20x30,2 (42,90%) - 20x20 (28,41%)

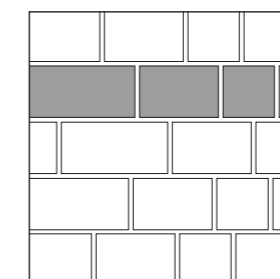

20x40,4 (44,59%) - 20x30,2 (33,33%) - 20x20 (22,08%)

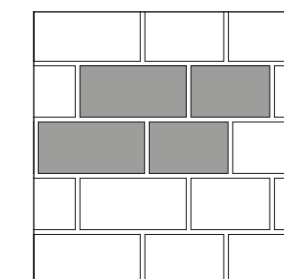

20x30,2 (42,78%) - 20x40,4 (57,22%)















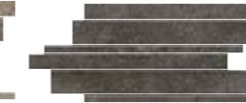



Fuga consigliata: vedi pag. 419\_Suggested joint: see pag. 419\_Empfohlene Fuge: siehe Seite 419\_Joint conseillé : voir page 419

\* Protezione antibatterica non presente\_No antimicrobial protection\_Der Antibakterielle Schutz nicht vorhanden\_Protection antibactérienne pas présente

# Pierre des Rêves

DECORI\_DECORS

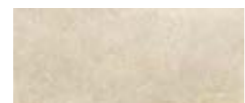
GRES PORCELLANATO A MASSA COLORATA\_COLOURED-BODY PORCELAIN STONWARE

 <p><b>REVEILLE</b></p> <p>MURETTO NATURALE 30x60 cm Rect - 12"x24" ± 9,5 mm PGZP8M4</p>  <p><b>NUAGE</b></p> <p>MURETTO NATURALE 30x60 cm Rect - 12"x24" ± 9,5 mm PGZP8M1</p>  <p><b>AURORE</b></p> <p>MURETTO NATURALE 30x60 cm Rect - 12"x24" ± 9,5 mm PGZP8M0</p>  <p><b>CHARME</b></p> <p>MURETTO NATURALE 30x60 cm Rect - 12"x24" ± 9,5 mm PGZP8M3</p>  <p><b>OUBLI</b></p> <p>MURETTO NATURALE 30x60 cm Rect - 12"x24" ± 9,5 mm PGZP8M2</p>	 <p><b>CHEVRON NATURALE</b> 29,2x39 cm Rect - 11 1/2"x15 3/8" ± 9,5 mm PGZP8C4</p>  <p><b>CHEVRON NATURALE</b> 29,2x39 cm Rect - 11 1/2"x15 3/8" ± 9,5 mm PGZP8C1</p>  <p><b>CHEVRON NATURALE</b> 29,2x39 cm Rect - 11 1/2"x15 3/8" ± 9,5 mm PGZP8C0</p>  <p><b>CHEVRON NATURALE</b> 29,2x39 cm Rect - 11 1/2"x15 3/8" ± 9,5 mm PGZP8C3</p>  <p><b>CHEVRON NATURALE</b> 29,2x39 cm Rect - 11 1/2"x15 3/8" ± 9,5 mm PGZP8C2</p>	 <p><b>MOSAICO 16 PEZZI NATURALE</b> 30x30 cm Rect - 12"x12" ± 9,5 mm PGZP890</p>  <p><b>MOSAICO 16 PEZZI NATURALE</b> 30x30 cm Rect - 12"x12" ± 9,5 mm PGZP860</p>  <p><b>MOSAICO 16 PEZZI NATURALE</b> 30x30 cm Rect - 12"x12" ± 9,5 mm PGZP850</p>  <p><b>MOSAICO 16 PEZZI NATURALE</b> 30x30 cm Rect - 12"x12" ± 9,5 mm PGZP880</p>  <p><b>MOSAICO 16 PEZZI NATURALE</b> 30x30 cm Rect - 12"x12" ± 9,5 mm PGZP870</p>	 <p><b>TABLEAU</b> 60x120 cm Rect - 24"x48" ± 9,5 mm PGXP8T1</p>  <p><b>TABLEAU</b> 60x120 cm Rect - 24"x48" ± 9,5 mm PGXP8T0</p>  <p><b>TABLEAU</b> 60x120 cm Rect - 24"x48" ± 9,5 mm PGXP8T3</p>  <p><b>TABLEAU</b> 60x120 cm Rect - 24"x48" ± 9,5 mm PGXP8T2</p>
--	--	---	--

**TABLEAU:**  
Decoro sviluppato su 2 soggetti diversi venduti insieme\_Decoration developed on 2 different patterns sold together\_Dekor zu 2 verschiedenen Themen entwickelt, die zusammen verkauft werden\_Décor développé sur 2 sujets différents vendus ensemble

## PEZZI SPECIALI\_TRIM PIECES

GRES A MASSA COLORATA\_COLOURED-BODY STONWARE

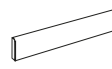
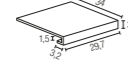
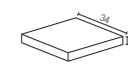
 <p><b>BATTISCOPIA</b> 7,5x60 cm Rect - 3"x24" ± 10 mm NATURALE</p>	 <p><b>GRADONE A COSTA RETTA</b> 30x34 cm Rect - 12"x13 3/8" ± 9,5 mm NATURALE</p>	 <p><b>ANGOLO GRADONE A COSTA RETTA</b> 34x34 cm - 13 3/8"x13 3/8" ± 9,5 mm NATURALE</p>	
REVEILLE	PGRP840	PGEP840	PGEP841
NUAGE	PGRP810	PGEP810	PGEP811
AURORE	PGRP800	PGEP800	PGEP801
CHARME	PGRP830	PGEP830	PGEP831
OUBLI	PGRP820	PGEP820	PGEP821

# Pierre des Rêves

PEZZI SPECIALI\_TRIM PIECES



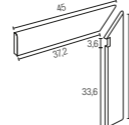
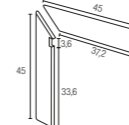
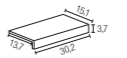
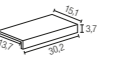



GRES PORCELLANATO A MASSA COLORATA\_COLOURED-BODY PORCELAIN STONWARE

 <p><b>BATTISCOPIA SCALA DX</b> (kit 2 pezzi) 7,5x45 cm - 3"x18" ± 10 mm NATURALE</p>	 <p><b>BATTISCOPIA SCALA SX</b> (kit 2 pezzi) 7,5x45 cm - 3"x18" ± 10 mm NATURALE</p>	 <p><b>ELEMENTO "L" MONOBLOCCO</b> 15x30x4 cm - 6"x12"x1 9/16" ± 12 mm STRUTTURATO*</p>	 <p><b>ELEMENTO "L"</b> 15x30x4 cm Rect - 6"x12"x1 9/16" ± 9,5 mm EXT*</p>
REVEILLE	PGZP84D	PGZP84S	/
NUAGE	PGZP81D	PGZP81S	PGZP810
AURORE	PGZP80D	PGZP80S	PGZP800
CHARME	PGZP83D	PGZP83S	/
OUBLI	PGZP82D	PGZP82S	PGZP820

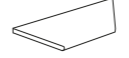
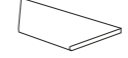
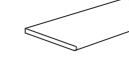
**ELEMENTO "L" MONOBLOCCO:**  
Abbinabile alla finitura Strutturato\_To be used with Strutturato version\_Kombinierbar mit Finish Strutturato\_Combinable à la finition Strutturato

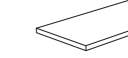
**ELEMENTO "L":**  
Realizzato tramite incollaggio\_Made by gluing\_Hergestellt durch Kleben\_Réalisé par collage  
Abbinabile alla finitura Ext\_To be used with Ext version\_Kombinierbar mit Finish Ext\_Combinable à la finition Ext

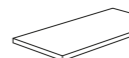
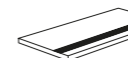
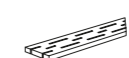
GRES PORCELLANATO A MASSA COLORATA\_COLOURED-BODY PORCELAIN STONWARE **20 mm**

 <p><b>COSTA TORO ANGOLARE DX</b> 30x60 cm Rect - 12"x24" STRUTTURATO*</p>	 <p><b>COSTA TORO ANGOLARE SX</b> 30x60 cm Rect - 12"x24" STRUTTURATO*</p>	 <p><b>COSTA TORO</b> 30x60 cm Rect - 12"x24" STRUTTURATO*</p>	 <p><b>COSTA TORO GRIP</b> 30x60 cm Rect - 12"x24" STRUTTURATO*</p>	 <p><b>COSTA RETTA ANGOLARE DX</b> 30x60 cm Rect - 12"x24" STRUTTURATO*</p>	 <p><b>COSTA RETTA ANGOLARE SX</b> 30x60 cm Rect - 12"x24" STRUTTURATO*</p>
REVEILLE	PGDP8K8	PGDP8K9	PGDP8F4	PGDP8J4	PGDP8D8
NUAGE	PGDP8K2	PGDP8K3	PGDP8F1	PGDP8J1	PGDP8D2
AURORE	PGDP8K0	PGDP8K1	PGDP8F0	PGDP8J0	PGDP8D0
CHARME	PGDP8K6	PGDP8K7	PGDP8F3	PGDP8J3	PGDP8D7
OUBLI	PGDP8K4	PGDP8K5	PGDP8F2	PGDP8J2	PGDP8D5
 <p><b>COSTA RETTA</b> 30x60 cm Rect - 12"x24" STRUTTURATO*</p>	 <p><b>COSTA RETTA GRIP</b> 30x60 cm Rect - 12"x24" STRUTTURATO*</p>	 <p><b>GRIGLIA ANGOLARE DX</b> 15x60 cm Rect - 6"x24" STRUTTURATO*</p>	 <p><b>GRIGLIA ANGOLARE SX</b> 15x60 cm Rect - 6"x24" STRUTTURATO*</p>	 <p><b>GRIGLIA</b> 15x60 cm Rect - 6"x24" STRUTTURATO*</p>	
REVEILLE	PGDP8C4	PGDP8G4	PG1P8A8	PG1P8A9	PGDP8Z4
NUAGE	PGDP8C1	PGDP8G1	PG1P8A2	PG1P8A3	PGDP8Z1
AURORE	PGDP8C0	PGDP8G0	PG1P8A0	PG1P8A1	PGDP8Z0
CHARME	PGDP8C3	PGDP8G3	PG1P8A6	PG1P8A7	PGDP8Z3
OUBLI	PGDP8C2	PGDP8G2	PG1P8A4	PG1P8A5	PGDP8Z2

\* Protezione antibatterica non presente\_No antimicrobial protection\_Der Antibakterielle Schutz nicht vorhanden\_Protection antibactérienne pas présente

## IMBALLAGGI E PESI\_PACKINGS AND WEIGHTS

DESCRIZIONE Description	± mm	FORMATI Sizes	SCATOLA_Box				PALLET		
			📦	KG	M <sup>2</sup>	ML	📦	KG	M <sup>2</sup>
FONDO NATURALE	9,5	60x120 <sup>RECT</sup>	2	31,8	1,44	-	36	1144,8	51,84
FONDO NATURALE	9,5	90x90 <sup>RECT</sup>	2	33,6	1,62	-	25	840	40,5
FONDO NATURALE / EXT	9,5	60x60 <sup>RECT</sup>	4	31,8	1,44	-	32	1017,6	46,08
FONDO NATURALE / EXT	9,5	30x60 <sup>RECT</sup>	8	31,8	1,44	-	32	1017,6	46,08
FONDO STRUTTURATO	12	20x40,4	10	21	0,808	-	54	1134	43,632
FONDO STRUTTURATO	12	20x30,2	15	23,1	0,906	-	48	1108,8	43,488
FONDO STRUTTURATO	12	20x20	22	22,2	0,88	-	45	999	39,6
FONDO STRUTTURATO	20	60x120 <sup>RECT</sup>	1	32,5	0,72	-	32	1040	23,04
TABLEAU	9,5	60x120 <sup>RECT</sup>	2	31,8	1,44	-	15	477	21,6
CHEVRON NATURALE	9,5	29,2x39 <sup>RECT</sup>	7	16,34	0,797	-	32	522,88	25,509
MURETTO NATURALE	9,5	30x60 <sup>RECT</sup>	4	15	0,72	-	30	450	21,6
MOSAICO 16 PEZZI NATURALE	9,5	30x30 <sup>RECT</sup>	4	7,5	0,36	-	78	585	28,08
BATTISCOPIA NATURALE	10	7,5x60 <sup>RECT</sup>	12	11,61	0,54	7,2	60	696,6	32,4
BATTISCOPIA SCALA (KIT 2 PZ.) NATURALE	10	7,5x45	5	7,5	0,337	-	-	-	-
GRADONE A COSTA RETTA NATURALE	9,5	30x34 <sup>RECT</sup>	6	19,95	0,612	-	30	598,5	18,36
ANGOLO GRADONE A COSTA RETTA NATURALE	9,5	34x34	2	6,27	0,231	-	48	300,96	11,097
ELEMENTO "L" EXT	9,5	15x30x4 <sup>RECT</sup>	8	8,7	0,36	2,4	48	419,52	17,28
ELEMENTO "L" MONOBLOCCO STRUTTURATO	12	15x30x4 <sup>RECT</sup>	8	12	0,36	2,4	44	528,0	15,84
COSTA TORO STRUTTURATO	20	30x60 <sup>RECT</sup>	1	8,125	0,18	-	100	812,5	18
COSTA TORO ANGOLARE STRUTTURATO	20	30x60 <sup>RECT</sup>	1	6,1	0,135	-	100	610	13,5
COSTA TORO GRIP STRUTTURATO	20	30x60 <sup>RECT</sup>	1	8,125	0,18	-	100	812,5	18
COSTA RETTA STRUTTURATO	20	30x60 <sup>RECT</sup>	1	8,125	0,18	-	100	812,5	18
COSTA RETTA ANGOLARE STRUTTURATO	20	30x60 <sup>RECT</sup>	1	6,1	0,135	-	100	610	13,5
COSTA RETTA GRIP STRUTTURATO	20	30x60 <sup>RECT</sup>	1	8,125	0,18	-	100	812,5	18
GRIGLIA STRUTTURATO	20	15x60 <sup>RECT</sup>	2	8	0,18	-	100	800	18
GRIGLIA ANGOLARE STRUTTURATO	20	15x60 <sup>RECT</sup>	2	7	0,157	-	100	700	15,75



# Pietre di Fanes



GRIGIO MISTO



ROSSO MISTO

GRES PORCELLANATO TUTTA MASSA\_FULL-BODY PORCELAIN STONEWARE



± 9 mm

20x41 cm  
8"x16<sup>1/8</sup>"

20x30,5 cm  
8"x12"

20x20 cm  
8"x8"



PAVIMENTO / FLOOR Grigio Misto Strutturato 20x20 cm - 8"x8" \_Coda di pavone maxi Grigio Misto Strutturato 138x87,5x26,5 cm - 54"x34<sup>1/2</sup>"x10<sup>1/2</sup>"



PAVIMENTO / FLOOR Rosso Misto Strutturato 20x20 cm - 8"x8" \_20x30,5 cm - 8"x12" \_20x41 cm - 8"x16<sup>1/8</sup>"

# Pietre di Fanes

## GRIGIO MISTO



## ROSSO MISTO



### GRES PORCELLANATO TUTTA MASSA\_FULL-BODY PORCELAIN STONEWARE

 ± 9 mm	 ± 9 mm	 ± 9 mm
<b>20x41 cm - 8"x16<sup>1/8</sup>"</b>	<b>20x30,5 cm - 8"x12"</b>	<b>20x20 cm - 8"x8"</b>
Grigio Misto STRUTTURATO PGKP705 Rosso Misto STRUTTURATO PGKP715	Grigio Misto STRUTTURATO PGBP705 Rosso Misto STRUTTURATO PGBP715	Grigio Misto STRUTTURATO PGE705 Rosso Misto STRUTTURATO PGE715

### SOLUZIONI DI POSA\_LAYING SOLUTIONS

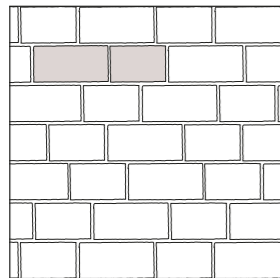

20x30,5 (42,66%) - 20x41 (57,34%)

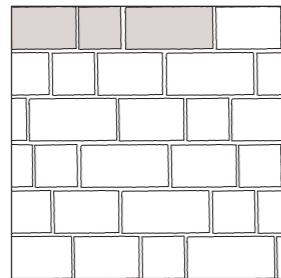

20x20 (21,86%) - 20x30,5 (33,33%)  
20x41 (44,81%)

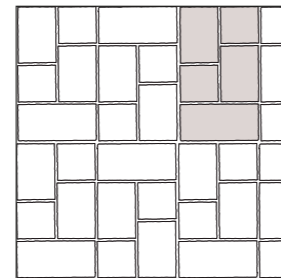







20x20 (28,17%) - 20x30,5 (42,96%)  
20x41 (28,87%)

Fuga consigliata: vedi pag. 419\_Suggested joint: see pag. 419\_Empfohlene Fuge: siehe Seite 419\_Joint conseillé : voir page 419

DESTINAZIONI D'USO\_INTENDED USE: STRUTTURATO 

### DATI TECNICI\_TECHNICAL DATA:

<b>GRES PORCELLANATO TUTTA MASSA</b> FULL-BODY PORCELAIN STONEWARE	
± 9 mm	
 DIN 51130: R11 Strutturato	
 DIN 51097: BCR TORTUS: μ > 0,40 Strutturato	
 ANSI A326.3: DCOF ≥ 0,42 Strutturato	
 EN 101: MOHS 9	
 CTI 81-7 ANNEX A: MOHS 9	
 ANSI A137.1: V4 Strutturato	

# Pietre di Fanes

## PEZZI SPECIALI\_TRIM PIECES

### GRES PORCELLANATO TUTTA MASSA\_FULL-BODY PORCELAIN STONEWARE

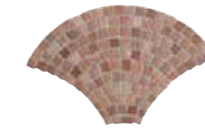

**CODA DI PAVONE MAXI (MQ. 0,67)**  
(KIT 4 PZ.)  
138x87,5x26,5 cm - 54"x34<sup>1/2</sup>"x10<sup>1/2</sup>"  
± 9 mm

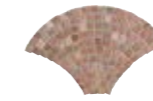

**CODA DI PAVONE (MQ. 0,40)**  
(KIT 4 PZ.)  
103x65x19 cm - 40<sup>1/2</sup>"x25<sup>1/2</sup>"x7<sup>1/2</sup>"  
± 9 mm

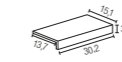

**ELEMENTO "L"**  
15x30x4 cm - 6"x12"x1<sup>9/16</sup>"  
± 9 mm

	STRUTTURATO	STRUTTURATO	STRUTTURATO
GRIGIO MISTO	PGZP709	PGZP705	PGZP7A0
ROSSO MISTO	PGZP719	PGZP715	PGZP7A1

### 1 Modulo Module / Modul / Module

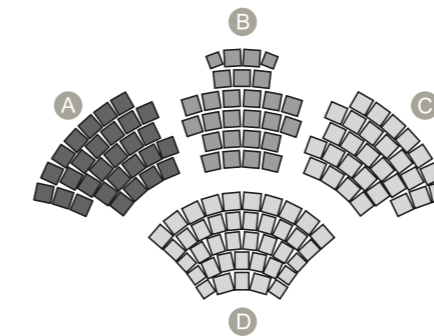

### 2 Montaggio Assembly / Versammlung / Montage

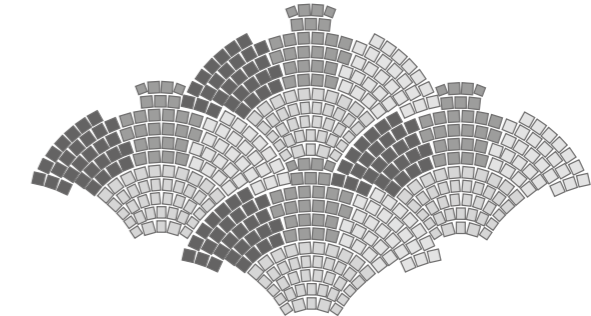



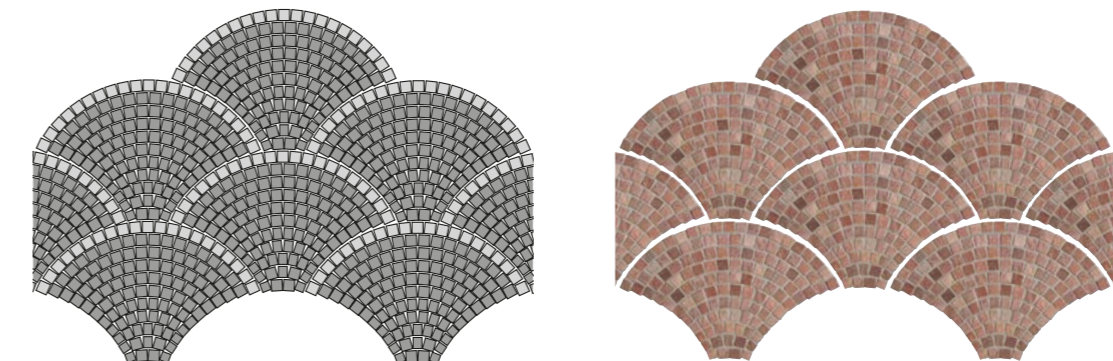



### 3 Risultato finale Final Result / Endergebnis / Résultat Final



Trattandosi di pezzi artigianali possono verificarsi piccole variazioni dimensionali\_Handmade pieces: light size variations may occur\_Da es sich um handgemachte Teile handelt, können es kleine dimensionale Veränderungen auftreten\_Étant donné qu'il s'agit de pièces faites à la main il peut y avoir des petits changements dimensionnels

### IMBALLAGGI E PESI\_PACKINGS AND WEIGHTS

DESCRIZIONE Description	± mm	FORMATI Sizes	SCATOLA_Box				PALLET			
										
FONDO STRUTTURATO	9	20x20	30	25	1,2	-	45	1125	54	
FONDO STRUTTURATO	9	20x30,5	20	23,1	1,22	-	48	1109	58,56	
FONDO STRUTTURATO	9	20x41	19	30,7	1,56	-	36	1105	56,09	
CODA DI PAVONE MAXI STRUTTURATO	9	MODULO 4 PZ.	1	9,8	0,67	-	44	431	29,48	
CODA DI PAVONE STRUTTURATO	9	MODULO 4 PZ.	1	7	0,4	-	40	280	16	
ELEMENTO "L" STRUTTURATO	9	15x30x4	8	9,6	0,36	2,40	48	461	17,28	



# Prime Stone



WHITE PRIME



SILVER PRIME



SAND PRIME



GREIGE PRIME

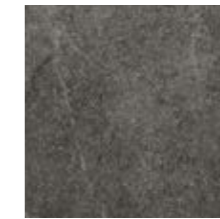

BLACK PRIME

GRES PORCELLANATO LAMINATO\_LAMINATED PORCELAIN STONEWARE **Zero.3**



± 5,5 mm



100x300 cm Rect  
39"x118"

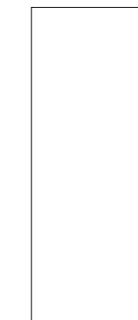

100x250 cm Rect  
39"x98<sup>1/2</sup>"

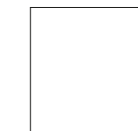

100x100 cm Rect  
39"x39"



50x100 cm Rect  
19<sup>1/2</sup>"x39"

GRES PORCELLANATO A MASSA COLORATA\_COLOURED-BODY PORCELAIN STONEWARE



± 9,5 mm



90x90 cm Rect  
36"x36"



45x90 cm Rect  
18"x36"



60x60 cm Rect  
24"x24"  
60,3x60,3 cm  
24"x24"



30x60 cm Rect  
12"x24"



20x60 cm Rect  
8"x24"



15x60 cm Rect  
6"x24"

GRES PORCELLANATO A MASSA COLORATA\_COLOURED-BODY PORCELAIN STONEWARE **20 mm**



± 20 mm



45x90 cm Rect  
18"x36"



RIVESTIMENTO / WALL Sand Prime Naturale 100x250 cm Rect - 39"x98<sup>1</sup>/<sub>2</sub>"\_Greige Prime Naturale 100x300 cm Rect - 39"x118"  
PAVIMENTO / FLOOR Sand Prime Naturale 100x100 cm Rect - 39"x39"





RIVESTIMENTO / WALL Muretto Silver Prime Soft 30x60 cm Rect - 12"x24"  
PAVIMENTO / FLOOR Black Prime Soft 45x90 cm Rect - 18"x36"

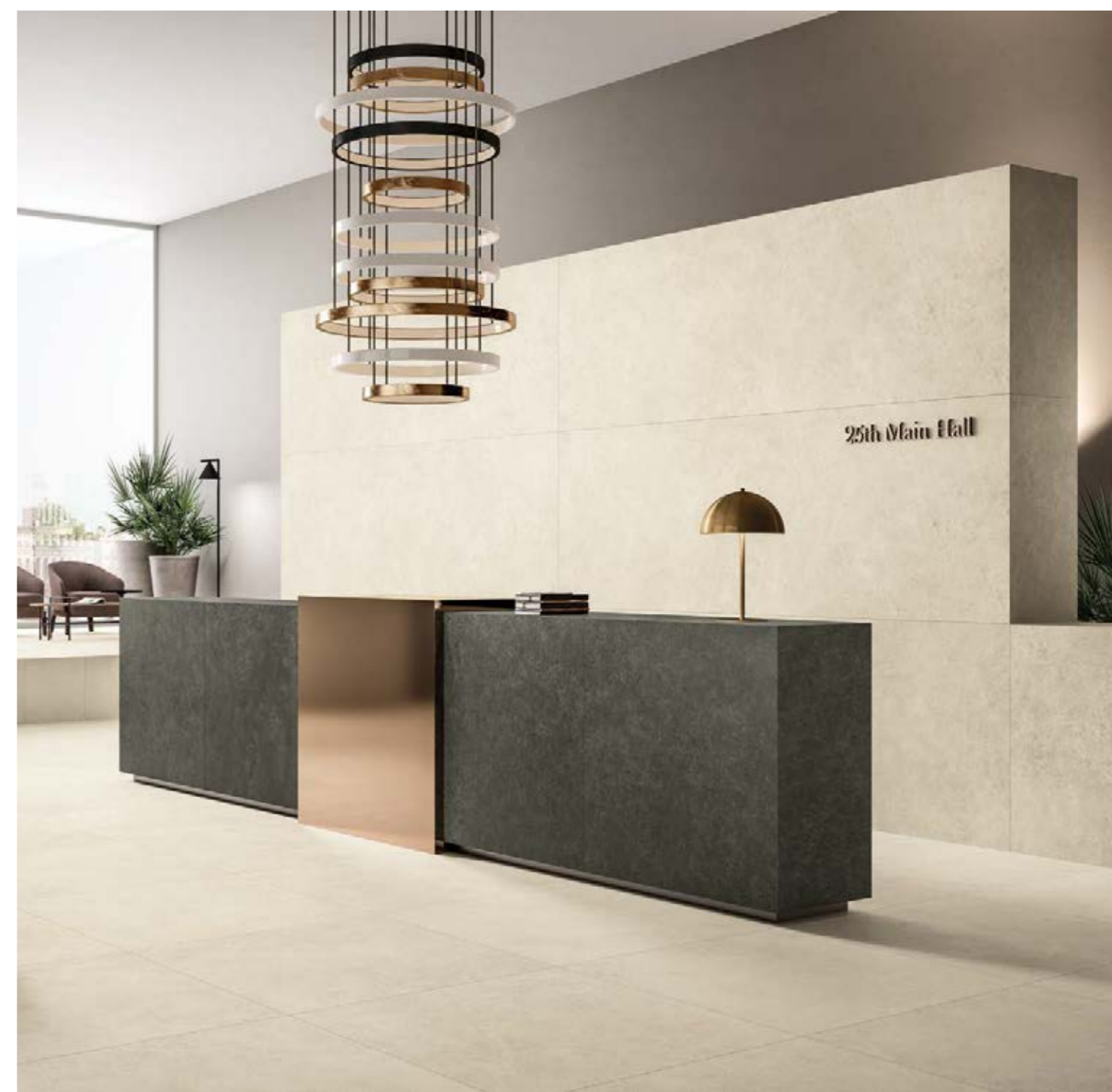

RIVESTIMENTO / WALL White Prime Naturale 100x300 cm Rect - 39"x118" \_Black Prime Naturale 100x300 cm Rect - 39"x118"  
Black Prime Naturale 50x100 cm Rect - 19 1/2"x39"  
PAVIMENTO / FLOOR White Prime Naturale 100x100 cm Rect - 39"x39"



RIVESTIMENTO / WALL White Prime Naturale 100x300 cm Rect - 39"x118" 100x250 cm Rect - 39"x98<sup>1/2</sup>"  
 PAVIMENTO / FLOOR Silver Prime Naturale 100x300 cm Rect - 39"x118" 100x100 cm Rect - 39"x39"



RIVESTIMENTO / WALL Greige Prime Naturale 100x300 cm Rect - 39"x118"  
 PAVIMENTO / FLOOR Greige Prime Naturale 100x100 cm Rect - 39"x39"



PAVIMENTO / FLOOR Greige Prime Strutturato 45x90 cm Rect - 18"x36" 20 mm

# Prime Stone

**PR( )TECT**  
ANTIBATTERICO - ANTIMICROBIAL

## WHITE PRIME



## SILVER PRIME



## SAND PRIME



## GREIGE PRIME



## BLACK PRIME

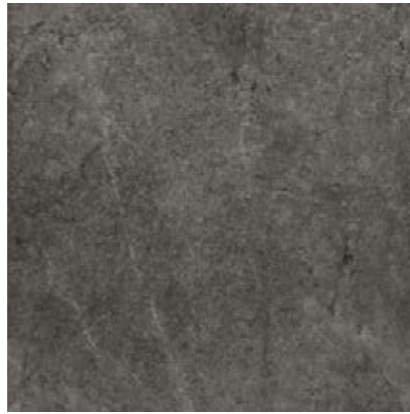

DESTINAZIONI D'USO\_INTENDED USE: **NATURALE** **SOFT** **LUX** **STRUTTURATO**

### DATI TECNICI\_TECHNICAL DATA:

GRES PORCELLANATO LAMINATO LAMINATED PORCELAIN STONEWARE	GRES A MASSA COLORATA COLOURED-BODY STONEWARE	GRES A MASSA COLORATA COLOURED-BODY STONEWARE
± 5,5 mm	9,5 mm	20 mm
DIN 51130: <b>R9</b> Naturale BCR TORTUS: $\mu > 0,40$ Naturale ANSI A326.3: <b>DCOF <math>\geq 0,42</math></b> Naturale	DIN 51130: <b>R9</b> Soft <b>R11</b> Strutturato DIN 51097: <b>C (A+B+C)</b> Strutturato BCR TORTUS: $\mu > 0,40$ Soft - Strutturato ANSI A326.3: <b>DCOF <math>\geq 0,42</math></b> Soft - Strutturato AS/NZS 4586: <b>P4</b> Strutturato BS 7976-2: <b>PTV 36+WET (Sl.96 - Sl.55)</b> Strutturato	DIN 51130: <b>R11</b> Strutturato DIN 51097: <b>C (A+B+C)</b> Strutturato BCR TORTUS: $\mu > 0,40$ Strutturato ANSI A326.3: <b>DCOF <math>\geq 0,42</math></b> Strutturato AS/NZS 4586: <b>P4</b> Strutturato BS 7976-2: <b>PTV 36+WET (Sl.96 - Sl.55)</b> Strutturato
ANSI A137.3: <b>V2</b> Naturale	ANSI A137.1: <b>V2</b> Soft - Lux - Strutturato	ANSI A137.1: <b>V2</b> Strutturato
<b>PR( )TECT</b> ANTIBATTERICO - ANTIMICROBIAL, Naturale	<b>PR( )TECT</b> ANTIBATTERICO - ANTIMICROBIAL, Soft - Lux	

# Prime Stone

## GRES PORCELLANATO LAMINATO\_LAMINATED PORCELAIN STONEWARE **Zero.3**

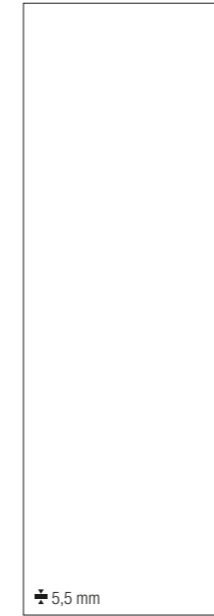

100x300 cm Rect - 39"x118"

White Prime NATURALE PZ7PM00  
Silver Prime NATURALE PZ7PM20  
Sand Prime NATURALE PZ7PM40  
Greige Prime NATURALE PZ7PM30  
Black Prime NATURALE PZ7PM10



100x250 cm Rect - 39"x98"<sup>1/2</sup>"

White Prime NATURALE PZ6PM00  
Silver Prime NATURALE PZ6PM20  
Sand Prime NATURALE PZ6PM40  
Greige Prime NATURALE PZ6PM30  
Black Prime NATURALE PZ6PM10

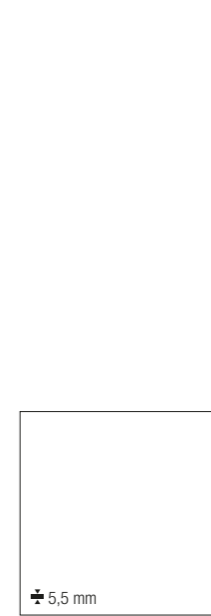

100x100 cm Rect - 39"x39"

White Prime NATURALE PZ8PM00  
Silver Prime NATURALE PZ8PM20  
Sand Prime NATURALE PZ8PM40  
Greige Prime NATURALE PZ8PM30  
Black Prime NATURALE PZ8PM10



50x100 cm Rect - 19"<sup>1/2</sup>"x39"

White Prime NATURALE PZ9PM00  
Silver Prime NATURALE PZ9PM20  
Sand Prime NATURALE PZ9PM40  
Greige Prime NATURALE PZ9PM30  
Black Prime NATURALE PZ9PM10

## GRES PORCELLANATO A MASSA COLORATA\_COLOURED-BODY PORCELAIN STONEWARE



90x90 cm Rect - 36"x36"

White Prime SOFT PGGPM00G  
Silver Prime SOFT PGGPM20G  
Sand Prime SOFT PGGPM40G  
Greige Prime SOFT PGGPM30G  
Black Prime SOFT PGGPM10G  
White Prime LUX PGGPML0G  
Silver Prime LUX PGGPML2G  
Sand Prime LUX PGGPML4G  
Greige Prime LUX PGGPML3G  
Black Prime LUX PGGPML1G



45x90 cm Rect - 18"x36"

White Prime SOFT PGHPMN0G  
Silver Prime SOFT PGHPMN2G  
Sand Prime SOFT PGHPMN4G  
Greige Prime SOFT PGHPMN3G  
Black Prime SOFT PGHPMN1G  
White Prime LUX PGHPML0G  
Silver Prime LUX PGHPML2G  
Sand Prime LUX PGHPML4G  
Greige Prime LUX PGHPML3G  
Black Prime LUX PGHPML1G

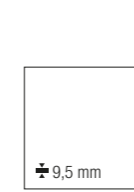

60x60 cm Rect - 24"x24"

White Prime SOFT PGWPM00  
Silver Prime SOFT PGWPM20  
Sand Prime SOFT PGWPM40  
Greige Prime SOFT PGWPM30  
Black Prime SOFT PGWPM10  
White Prime LUX PGWPML0  
Silver Prime LUX PGWPML2  
Sand Prime LUX PGWPML4  
Greige Prime LUX PGWPML3  
Black Prime LUX PGWPML1

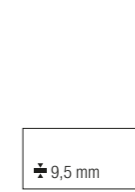

30x60 cm Rect - 12"x24"

White Prime SOFT PG-PM00  
Silver Prime SOFT PG-PM20  
Sand Prime SOFT PG-PM40  
Greige Prime SOFT PG-PM30  
Black Prime SOFT PG-PM10  
Silver Prime STRUTTURATO\* PG-PMS2  
Sand Prime STRUTTURATO\* PG-PMS4



20x60 cm Rect - 8"x24"

Silver Prime STRUTTURATO\* PG2PMS2  
Sand Prime STRUTTURATO\* PG2PMS4

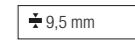

15x60 cm Rect - 6"x24"

Silver Prime STRUTTURATO\* PG1PMS2  
Sand Prime STRUTTURATO\* PG1PMS4

60,3x60,3 cm Rect - 24"x24"  
Silver Prime STRUTTURATO\* PGWPMS2  
Sand Prime STRUTTURATO\* PGWPMS4

## GRES PORCELLANATO A MASSA COLORATA\_COLOURED-BODY PORCELAIN STONEWARE **20 mm**

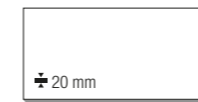

45x90 cm Rect - 18"x36"

Silver Prime STRUTTURATO\* PGHPM21  
Sand Prime STRUTTURATO\* PGHPM41  
Greige Prime STRUTTURATO\* PGHPM31  
Black Prime STRUTTURATO\* PGHPM11

\* Protezione antibatterica non presente\_No antimicrobial protection\_Der Antibakterielle Schutz nicht vorhanden\_Protection antibactérienne pas présente

# Prime Stone

## DECORI\_DECORS

GRES PORCELLANATO A MASSA COLORATA\_COLOURED-BODY PORCELAIN STONWARE

### WHITE PRIME



**MURETTO SOFT**  
30x60 cm Rect - 12"x24"  
± 9,5 mm  
PG-PMM0



**MOSAICO 16 PEZZI SOFT**  
30x30 cm Rect - 12"x12"  
± 9,5 mm  
PGZPM00

### SILVER PRIME



**MURETTO SOFT**  
30x60 cm Rect - 12"x24"  
± 9,5 mm  
PG-PMM2



**MOSAICO 16 PEZZI SOFT**  
30x30 cm Rect - 12"x12"  
± 9,5 mm  
PGZPM20

### SAND PRIME



**MURETTO SOFT**  
30x60 cm Rect - 12"x24"  
± 9,5 mm  
PG-PMM4



**MOSAICO 16 PEZZI SOFT**  
30x30 cm Rect - 12"x12"  
± 9,5 mm  
PGZPM40

### GREIGE PRIME



**MURETTO SOFT**  
30x60 cm Rect - 12"x24"  
± 9,5 mm  
PG-PMM3



**MOSAICO 16 PEZZI SOFT**  
30x30 cm Rect - 12"x12"  
± 9,5 mm  
PGZPM30

### BLACK PRIME



**MURETTO SOFT**  
30x60 cm Rect - 12"x24"  
± 9,5 mm  
PG-PMM1



**MOSAICO 16 PEZZI SOFT**  
30x30 cm Rect - 12"x12"  
± 9,5 mm  
PGZPM10

## PEZZI SPECIALI\_TRIM PIECES

GRES PORCELLANATO A MASSA COLORATA\_COLOURED-BODY PORCELAIN STONWARE

	BATTISCOPA	ANGOLO GRADONE A COSTA RETTA	GRADONE A COSTA RETTA	BATTISCOPA SCALA DX (kit 2 pezzi)	BATTISCOPA SCALA SX (kit 2 pezzi)	ELEMENTO "L"
	10x60 cm Rect - 4"x24" ± 10 mm SOFT LUX	34x34 cm - 13 <sup>3/8</sup> "x13 <sup>3/8</sup> " ± 9,5 mm SOFT	30x34 cm Rect - 12"x13 <sup>3/8</sup> " ± 9,5 mm SOFT	10x45 cm - 4"x18" ± 10 mm SOFT	10x45 cm - 4"x18" ± 10 mm SOFT	15x30x4 cm - 6"x12"x1 <sup>9/16</sup> " ± 9 mm STRUTTURATO*
WHITE PRIME	PGRPM00	PGRPML0	PGEPM01	PGEPM00	PGZPM0D	PGZPM0S
SILVER PRIME	PGRPM20	PGRPML2	PGEPM21	PGEPM20	PGZPM2D	PGZPM2S
SAND PRIME	PGRPM40	PGRPML4	PGEPM41	PGEPM40	PGZPM4D	PGZPM4S
GREIGE PRIME	PGRPM30	PGRPML3	PGEPM31	PGEPM30	PGZPM3D	PGZPM3S
BLACK PRIME	PGRPM10	PGRPML1	PGEPM11	PGEPM10	PGZPM1D	PGZPM1S

\* Protezione antibatterica non presente\_No antimicrobial protection\_Der Antibakterielle Schutz nicht vorhanden\_Protection antibactérienne pas présente

# Prime Stone

## PEZZI SPECIALI\_TRIM PIECES

GRES PORCELLANATO A MASSA COLORATA\_COLOURED-BODY PORCELAIN STONWARE **20 mm**

	COSTA TORO ANGOLARE DX	COSTA TORO ANGOLARE SX	COSTA TORO	COSTA TORO GRIP	COSTA RETTA ANGOLARE DX	COSTA RETTA ANGOLARE SX
	30x90 cm Rect - 12"x36" STRUTTURATO*	30x90 cm Rect - 12"x36" STRUTTURATO*	30x90 cm Rect - 12"x36" STRUTTURATO*	30x90 cm Rect - 12"x36" STRUTTURATO*	30x90 cm Rect - 12"x36" STRUTTURATO*	30x90 cm Rect - 12"x36" STRUTTURATO*
SILVER PRIME	PGDPMK2	PGDPMK7	PGFPMF2	PGFPMJ2	PGDPM2	PGDPM7
SAND PRIME	PGDPMK4	PGDPMK9	PGFPMF4	PGFPMJ4	PGDPM4	PGDPM9
GREIGE PRIME	PGDPMK3	PGDPMK6	PGFPMF3	PGFPMJ3	PGDPM3	PGDPM6
BLACK PRIME	PGDPMK1	PGDPMK5	PGFPMF1	PGFPMJ1	PGDPM1	PGDPM5

	COSTA RETTA	COSTA RETTA GRIP	GRIGLIA ANGOLARE DX	GRIGLIA ANGOLARE SX	GRIGLIA
	30x90 cm Rect - 12"x36" STRUTTURATO*	30x90 cm Rect - 12"x36" STRUTTURATO*	15x45 cm Rect - 6"x18" STRUTTURATO*	15x45 cm Rect - 6"x18" STRUTTURATO*	15x45 cm Rect - 6"x18" STRUTTURATO*
SILVER PRIME	PGFPMC2	PGFPMG2	PGDPMA2	PGDPMA7	PGDPMZ2
SAND PRIME	PGFPMC4	PGFPMG4	PGDPMA4	PGDPMA9	PGDPMZ4
GREIGE PRIME	PGFPMC3	PGFPMG3	PGDPMA3	PGDPMA6	PGDPMZ3
BLACK PRIME	PGFPMC1	PGFPMG1	PGDPMA1	PGDPMA5	PGDPMZ1

\* Protezione antibatterica non presente\_No antimicrobial protection\_Der Antibakterielle Schutz nicht vorhanden\_Protection antibactérienne pas présente

## IMBALLAGGI E PESI\_PACKINGS AND WEIGHTS

DESCRIZIONE Description	± mm	FORMATI Sizes	SCATOLA_Box				PALLET		
FONDO NATURALE	5,5	100x300 <sup>RECT</sup>	1	34,5	3	-	13	448,5	39
FONDO NATURALE	5,5	100x250 <sup>RECT</sup>	1	28,75	2,5	-	13	373,75	32,5
FONDO NATURALE	5,5	100x100 <sup>RECT</sup>	2	23	2	-	25	575	50
FONDO NATURALE	5,5	50x100 <sup>RECT</sup>	3	17,25	1,5	-	32	552	48
FONDO SOFT / LUX	9,5	90x90 <sup>RECT</sup>	2	33,6	1,62	-	25	840	40,5
FONDO SOFT / LUX	9,5	45x90 <sup>RECT</sup>	3	25,9	1,215	-	36	907,2	43,74
FONDO SOFT / LUX	9,5	60x60 <sup>RECT</sup>	4	31,8	1,44	-	32	1018	46,1
FONDO SOFT / STRUTTURATO	9,5	30x60 <sup>RECT</sup>	8	31,8	1,44	-	32	1018	46,1
FONDO STRUTTURATO	9,5	60,3x60,3	4	31,8	1,45	-	32	1018	46,5
FONDO STRUTTURATO	9,5	20x60 <sup>RECT</sup>	13	31,9	1,56	-	30	957	46,8
FONDO STRUTTURATO	9,5	15x60 <sup>RECT</sup>	16	29,5	1,44	-	32	942	46,1
MOSAICO 16 PEZZI SOFT	9,5	30x30 <sup>RECT</sup>	4	7,2	0,36	-	78	562	28,1
MURETTO SOFT	9,5	30x60 <sup>RECT</sup>	4	15,7	0,72	-	30	471	21,6
BATTISCOPA SOFT	10	10x60 <sup>RECT</sup>	12	15	0,72	7,2	60	900	43,2
BATTISCOPA LUX	10	10x60 <sup>RECT</sup>	12	15	0,72	7,2	56	900	840
BATTISCOPA SCALA (KIT 2 PZ.) SOFT	10	10x45	5	8,5	0,43	-	-	-	-
GRADONE A COSTA RETTA SOFT	9,5	30x34 <sup>RECT</sup>	6	17,1	0,61	-	30	513	18,4
ANGOLO GRADONE A COSTA RETTA SOFT	9,5	34x34	2	6,3	0,23	-	48	301	11,1
ELEMENTO "L" STRUTTURATO	9	15x30x4	8	9,6	0,36	2,4	48	461	17,28
FONDO STRUTTURATO	20	45x90 <sup>RECT</sup>	2	36,23	0,81	-	24	870	19,44
COSTA TORO STRUTTURATO	20	30x90 <sup>RECT</sup>	1	12,2	0,27	-	32	390	8,64
COSTA TORO ANGOLARE STRUTTURATO	20	30x90 <sup>RECT</sup>	1	10,2	0,23	-	32	326	7,2
COSTA TORO GRIP STRUTTURATO	20	30x90 <sup>RECT</sup>	1	12,2	0,27	-	32	390	8,64
COSTA RETTA STRUTTURATO	20	30x90 <sup>RECT</sup>	1	12,2	0,27	-	32	390	8,64
COSTA RETTA ANGOLARE STRUTTURATO	20	30x90 <sup>RECT</sup>	1	10,2	0,23	-	32	326	7,2
COSTA RETTA GRIP STRUTTURATO	20	30x90 <sup>RECT</sup>	1	12,2	0,27	-	32	390	8,64
GRIGLIA STRUTTURATO	20	15x45 <sup>RECT</sup>	4	11,2	0,27	-	48	538	12,96
GRIGLIA ANGOLARE STRUTTURATO	20	15x45 <sup>RECT</sup>	4	10	0,23	-	48	480	10,8



# Rock Style

Fiordo



R-GOLD

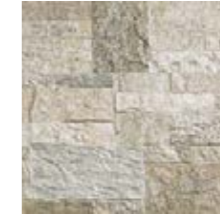

R-SILVER



R-ROYAL

GRES PORCELLANATO SMALTATO \_GLAZED PORCELAIN STONEWARE



± 10 mm



30x56,5 cm  
12"x22<sup>1/4</sup>"



RIVESTIMENTO / WALL R-Royal Naturale 30x56,5 cm - 12"x22<sup>1/4</sup>"



RIVESTIMENTO / WALL R-Gold Naturale 30x56,5 cm - 12"x22<sup>1/4</sup>"



RIVESTIMENTO / WALL R-Royal Naturale 30x56,5 cm - 12"x22<sup>1/4</sup>"\_R-Silver Naturale 30x56,5 cm - 12"x22<sup>1/4</sup>"



# Rock Style

GRES PORCELLANATO SMALTATO\_GLAZED PORCELAIN STONWARE

## R-GOLD



30x56,5 cm - 12"x22<sup>1/4</sup>"  
± 10 mm

R-Gold NATURALE FG-RS10

## R-SILVER



30x56,5 cm - 12"x22<sup>1/4</sup>"  
± 10 mm

R-Silver NATURALE FG-RS00

## R-ROYAL



30x56,5 cm - 12"x22<sup>1/4</sup>"  
± 10 mm

R-Royal NATURALE FG-RS20

### DATI TECNICI\_TECHNICAL DATA:

<b>GRES PORCELLANATO SMALTATO</b> GLAZED PORCELAIN STONWARE	
±	10 mm
	ANSI A137.1: V3 Naturale

### PEZZI SPECIALI\_TRIM PIECES

GRES PORCELLANATO SMALTATO\_GLAZED PORCELAIN STONWARE

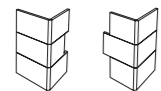

Pezzo / Piece A Pezzo / Piece B

**ROUND CORNER**  
16x12x30 cm - 6<sup>1/8</sup>"x4<sup>3/8</sup>"x12"  
± 10 mm  
NATURALE

R-GOLD	FGZRS50
R-SILVER	FGZRS70
R-ROYAL	FGZRS60

### IMBALLAGGI E PESI\_PACKINGS AND WEIGHTS

DESCRIZIONE Description	± mm	FORMATI Sizes	SCATOLA_Box				PALLET			
FONDO NATURALE	10	30x56,5	7	25,8	1,19	-	32	825,6	37,97	
ROUND CORNER NATURALE	10	16x12x30	4	6,8	0,192	1,2	28	190,4	5,38	

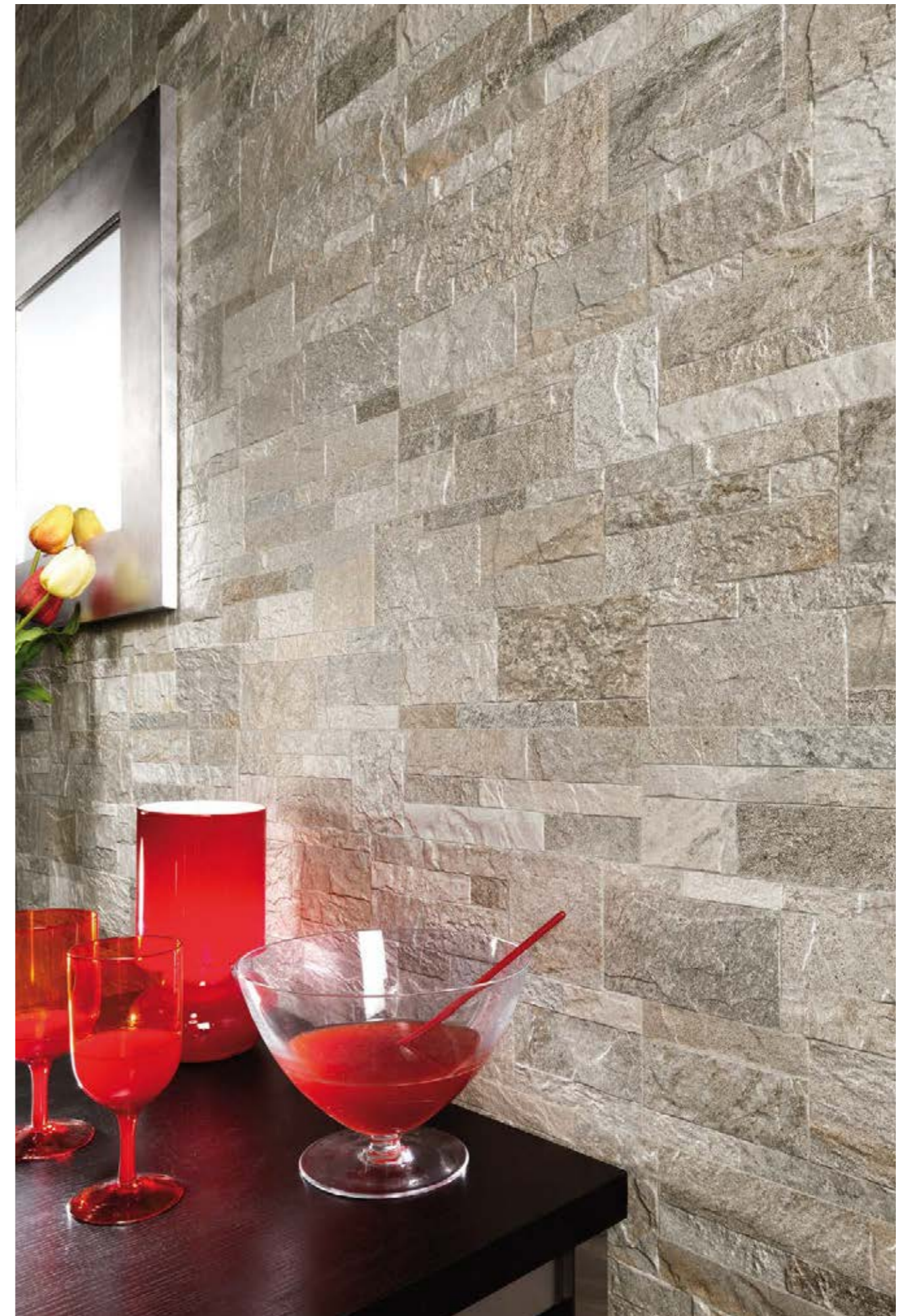

RIVESTIMENTO / WALL R-Silver Naturale 30x56,5 cm - 12"x22<sup>1/4</sup>"

# Stone Trace



GLADE



CREEK



CREST



ABYSS



HOLLOW

GRES PORCELLANATO LAMINATO / LAMINATED PORCELAIN STONEWARE **Zero.3**



± 6 mm



120x278 cm Rect  
48"x109<sup>1/2</sup>"

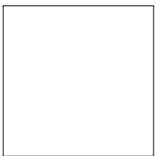

120x120 cm Rect  
48"x48"



60x120 cm Rect  
24"x48"



RIVESTIMENTO / WALL Crest Naturale 120x278 cm Rect - 48"x109<sup>1/2</sup>"  
PAVIMENTO / FLOOR Frame Peak Strutturato 45x90 cm Rect - 18"x36" 20 mm



RIVESTIMENTO / WALL Creek Naturale 120x278 cm Rect - 48"x109 1/2"  
PAVIMENTO / FLOOR Creek Naturale 120x120 cm Rect - 48"x48"



RIVESTIMENTO / WALL Glade Naturale 120x278 cm Rect - 48"x109<sup>1</sup>/<sub>2</sub>"\_Abyss Naturale 120x278 cm Rect - 48"x109<sup>1</sup>/<sub>2</sub>"\_Glam Greenwall 50x100 cm Rect - 19<sup>1</sup>/<sub>2</sub>"x39"  
 PAVIMENTO / FLOOR Abyss Naturale 60x120 cm Rect - 24"x48"



RIVESTIMENTO / WALL Glade Naturale 120x278 cm Rect - 48"x109<sup>1</sup>/<sub>2</sub>"  
 PAVIMENTO / FLOOR Glade Naturale 60x120 cm Rect - 24"x48"  
 TOP CUCINA E TAVOLO / COUNTERTOP AND TABLE Abyss Naturale



RIVESTIMENTO / WALL Hollow Naturale 120x278 cm Rect - 48"x109<sup>1/2</sup>"  
PAVIMENTO / FLOOR Hollow Naturale 120x120 cm Rect - 48"x48"

# Stone Trace

**PR( )TECT**  
ANTIBATTERICO - ANTIMICROBIAL

GLADE



CREEK



CREST



ABYSS



HOLLOW



# Stone Trace

GRES PORCELLANATO LAMINATO\_LAMINATED PORCELAIN STONEWARE **Zero.3**



120x278 cm Rect - 48"x109 1/2"

Glade NATURALE	PZ6ST30
Creek NATURALE	PZ6ST10
Crest NATURALE	PZ6ST20
Hollow NATURALE	PZ6ST40
Abyss NATURALE	PZ6ST00

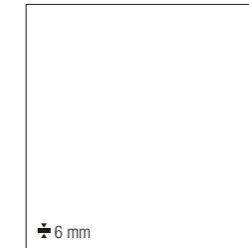

120x120 cm Rect - 48"x48"

Glade NATURALE	PZ8ST30
Creek NATURALE	PZ8ST10
Crest NATURALE	PZ8ST20
Hollow NATURALE	PZ8ST40
Abyss NATURALE	PZ8ST00



60x120 cm Rect - 24"x48"

Glade NATURALE	PZXST30
Creek NATURALE	PZXST10
Crest NATURALE	PZXST20
Hollow NATURALE	PZXST40
Abyss NATURALE	PZXST00

DESTINAZIONI D'USO\_INTENDED USE: NATURALE

DATI TECNICI\_TECHNICAL DATA:

**GRES PORCELLANATO LAMINATO**  
LAMINATED PORCELAIN STONEWARE

6 mm

DIN 51130: **R10** Naturale  
BCR TORTUS:  $\mu > 0,40$  Naturale  
ANSI A326.3: **DCOF  $\geq 0.42$**  Naturale

ANSI A137.3: **V2** Naturale (Glade-Creek-Crest-Abyss)  
**V3** Naturale (Hollow)

**PR( )TECT**  
ANTIBATTERICO - ANTIMICROBIAL Naturale

## IMBALLAGGI E PESI\_PACKINGS AND WEIGHTS

DESCRIZIONE Description	mm	FORMATI Sizes	SCATOLA_Box				PALLET		
FONDO NATURALE	6	120x278 <sup>RECT</sup>	1	47	3,336	-	18	846	60,048
FONDO NATURALE	6	120x120 <sup>RECT</sup>	2	39,8	2,88	-	25	995	72
FONDO NATURALE	6	60x120 <sup>RECT</sup>	3	30,3	2,16	-	16	484,8	34,56



# Tracks

Fiordo



PALE



SOIL



ASH



MUD

GRES PORCELLANATO A MASSA COLORATA\_COLOURED-BODY PORCELAIN STONEWARE



± 9,5 mm



60x60 cm Rect  
24"x24"  
60,3x60,3 cm  
24"x24"



30x60 cm Rect  
12"x24"

GRES PORCELLANATO A MASSA COLORATA\_COLOURED-BODY PORCELAIN STONEWARE **20 mm**



± 20 mm



60x60 cm Rect  
24"x24"





PAVIMENTO / FLOOR Ash Naturale 60x60 cm Rect - 24"x24"



RIVESTIMENTO / WALL Pale Naturale 30x60 cm Rect - 12"x24"  
PAVIMENTO / FLOOR Pale Naturale 60x60 cm Rect - 24"x24"



PAVIMENTO / FLOOR Mud Naturale 60x60 cm Rect - 24"x24"



PAVIMENTO / FLOOR Mud Strutturato 60x60 cm Rect - 24"x24" 20 mm

# Tracks

## PALE



## SOIL



## ASH



## MUD



DESTINAZIONI D'USO\_INTENDED USE: NATURALE STRUTTURATO

### DATI TECNICI\_TECHNICAL DATA:

GRES PORCELLANATO A MASSA COLORATA COLOURED-BODY PORCELAIN STONWARE		GRES PORCELLANATO A MASSA COLORATA COLOURED-BODY PORCELAIN STONWARE	
±	9,5 mm	±	20 mm
	DIN 51130: <b>R10</b> Naturale DIN 51097: <b>A</b> Naturale (Pale) <b>B (A+B)</b> Naturale (Soil, Ash, Mud) BCR TORTUS: $\mu > 0,40$ Naturale ANSI A326.3: <b>DCOF</b> $\geq 0,42$ Naturale		DIN 51130: <b>R11</b> Strutturato DIN 51097: <b>C (A+B+C)</b> Strutturato BCR TORTUS: $\mu > 0,40$ Strutturato ANSI A326.3: <b>DCOF</b> $\geq 0,42$ Strutturato
	ANSI A137.1: <b>V2</b> Naturale		ANSI A137.1: <b>V2</b> Strutturato

# Tracks

## GRES PORCELLANATO A MASSA COLORATA\_COLOURED-BODY PORCELAIN STONWARE



60x60 cm Rect - 24"x24"

Pale NATURALE FGWTKR2  
Soil NATURALE FGWTKR3  
Ash NATURALE FGWTKR0  
Mud NATURALE FGWTKR1

60,3x60,3 cm - 24"x24"

Pale NATURALE FGWTK20  
Soil NATURALE FGWTK30  
Ash NATURALE FGWTK00  
Mud NATURALE FGWTK10

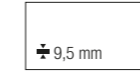

30x60 cm Rect - 12"x24"

Pale NATURALE FG-TKR2  
Soil NATURALE FG-TKR3  
Ash NATURALE FG-TKR0  
Mud NATURALE FG-TKR1

## GRES PORCELLANATO A MASSA COLORATA\_COLOURED-BODY PORCELAIN STONWARE 20 mm



60x60 cm Rect - 24"x24"

Soil STRUTTURATO FGWTK63  
Ash STRUTTURATO FGWTK60  
Mud STRUTTURATO FGWTK61

## PEZZI SPECIALI\_TRIM PIECES

### GRES PORCELLANATO A MASSA COLORATA\_COLOURED-BODY PORCELAIN STONWARE

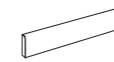

**BATTISCOPA**  
10x60 cm Rect - 4"x24"  
± 10 mm  
NATURALE

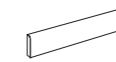

**BATTISCOPA**  
10x60,3 cm - 4"x24"  
± 10 mm  
NATURALE

	BATTISCOPA 10x60 cm Rect - 4"x24"	BATTISCOPA 10x60,3 cm - 4"x24"
PALE	FGRTKR2	FGRTK20
SOIL	FGRTKR3	FGRTK30
ASH	FGRTKR0	FGRTK00
MUD	FGRTKR1	FGRTK10

## IMBALLAGGI E PESI\_PACKINGS AND WEIGHTS

DESCRIZIONE Description	± mm	FORMATI Sizes	SCATOLA_Box				PALLET			
FONDO NATURALE	9,5	60x60 RECT	4	31,8	1,44	-	32	1018	46,1	
FONDO NATURALE	9,5	60,3x60,3	4	31,8	1,45	-	32	1018	46,5	
FONDO NATURALE	9,5	30x60 RECT	8	31,8	1,44	-	32	1018	46,1	
BATTISCOPA NATURALE	10	10x60 RECT	12	15,48	0,72	7,2	60	928,8	43,2	
BATTISCOPA NATURALE	10	10x60,3	16	20	0,9648	9,648	48	960	46,31	
FONDO STRUTTURATO	20	60x60 RECT	2	33	0,72	-	32	1056	23,04	



# Effetto cemento

Concrete look\_Zement-Optik\_Effet ciment



RIVESTIMENTO / WALL Square Naturale 120x260 cm Rect - 48"x102"  
 PAVIMENTO / FLOOR Square Naturale 60x60 cm Rect - 24"x24"

# Context



SQUARE



LOFT



STORE

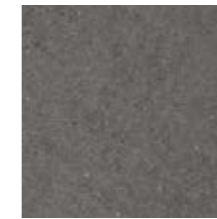

HANGAR

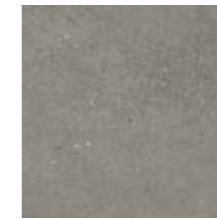

MANSION

GRES PORCELLANATO LAMINATO\_LAMINATED PORCELAIN STONEWARE **Zero.3**



± 6 mm



120x260 cm Rect  
48"x102"



120x120 cm Rect  
48"x48"

GRES PORCELLANATO A MASSA COLORATA\_COLOURED-BODY PORCELAIN STONEWARE



± 9,5 mm



90x90 cm Rect  
36"x36"



60x120 cm Rect  
24"x48"



60x60 cm Rect  
24"x24"  
60,3x60,3 cm  
24"x24"



30x60 cm Rect  
12"x24"

GRES PORCELLANATO A MASSA COLORATA\_COLOURED-BODY PORCELAIN STONEWARE **20 mm**



± 20 mm



60x120 cm Rect  
24"x48"



RIVESTIMENTO / WALL Mansion Naturale 120x260 cm Rect - 48"x102"\_Muretto 3D Mansion Naturale 30x60 cm - 12"x24"  
PAVIMENTO / FLOOR Mansion Naturale 90x90 cm Rect - 36"x36"



RIVESTIMENTO / WALL Square Naturale 120x260 cm Rect - 48"x102"  
PAVIMENTO / FLOOR Square Strutturato 60x60 cm Rect - 24"x24" \_Square Strutturato 60x120 cm Rect - 24"x48" 20 mm



RIVESTIMENTO / WALL Hangar Naturale 120x260 cm Rect - 48"x102"  
PAVIMENTO / FLOOR Hangar Naturale 60x60 cm Rect - 24"x24"



RIVESTIMENTO / WALL Loft Naturale 120x260 cm Rect - 48"x102"  
PAVIMENTO / FLOOR Venice Loft Naturale 60x60 cm Rect - 24"x24"





RIVESTIMENTO / WALL Loft Naturale 120x260 cm Rect - 48"x102"  
PAVIMENTO / FLOOR Loft Naturale 120x120 cm Rect - 48"x48"



RIVESTIMENTO / WALL Store Naturale 120x260 cm Rect - 48"x102"  
PAVIMENTO / FLOOR Store Naturale 120x120 cm Rect - 48"x48"

## SQUARE



## LOFT



## STORE



## HANGAR



## MANSION



DESTINAZIONI D'USO\_INTENDED USE: NATURALE STRUTTURATO / EXT

### DATI TECNICI\_TECHNICAL DATA:

GRES PORCELLANATO LAMINATO LAMINATED PORCELAIN STONWARE	GRES PORCELLANATO A MASSA COLORATA COLOURED-BODY PORCELAIN STONWARE	GRES PORCELLANATO A MASSA COLORATA COLOURED-BODY PORCELAIN STONWARE
6 mm	9,5 mm	20 mm
DIN 51130: <b>R10</b> Naturale BCR TORTUS: $\mu > 0,40$ Naturale ANSI A326.3: <b>DCOF <math>\geq 0,42</math></b> Naturale	DIN 51130: <b>R10</b> Naturale <b>R11</b> Strutturato - Ext DIN 51097: <b>B (A+B)</b> Naturale <b>C (A+B+C)</b> Strutturato - Ext BCR TORTUS: $\mu > 0,40$ Naturale - Strutturato - Ext ANSI A326.3: <b>DCOF <math>\geq 0,42</math></b> Naturale - Strutturato - Ext AS/NZS 4586: <b>P3</b> Naturale <b>P4</b> Strutturato - Ext BS 7976-2: <b>PTV 36+WET (SI.96)</b> Naturale <b>PTV 36+WET (SI.96 - SI.55)</b> Strutturato - Ext	DIN 51130: <b>R11</b> Strutturato DIN 51097: <b>C (A+B+C)</b> Strutturato BCR TORTUS: $\mu > 0,40$ Strutturato ANSI A326.3: <b>DCOF <math>\geq 0,42</math></b> Strutturato AS/NZS 4586: <b>P4</b> Strutturato BS 7976-2: <b>PTV 36+WET (SI.96 - SI.55)</b> Strutturato
ANSI A137.3: <b>V2</b> Naturale	ANSI A137.1: <b>V2</b> Naturale - Strutturato - Ext	ANSI A137.1: <b>V2</b> Strutturato
<b>PR( )TECT</b> ANTIBATTERICO - ANTIMICROBIAL Naturale	<b>PR( )TECT</b> ANTIBATTERICO - ANTIMICROBIAL Naturale	

## GRES PORCELLANATO LAMINATO\_LAMINATED PORCELAIN STONWARE **Zero.3**



**120x260 cm Rect - 48"x102"**  
Square NATURALE PZ6XT301  
Loft NATURALE PZ6XT101  
Store NATURALE PZ6XT401  
Hangar NATURALE PZ6XT001  
Mansion NATURALE PZ6XT201

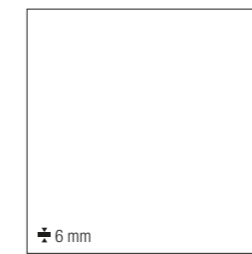

**120x120 cm Rect - 48"x48"**  
Square NATURALE PZ8XT30  
Loft NATURALE PZ8XT10  
Store NATURALE PZ8XT40  
Hangar NATURALE PZ8XT00  
Mansion NATURALE PZ8XT20

## GRES PORCELLANATO A MASSA COLORATA\_COLOURED-BODY PORCELAIN STONWARE

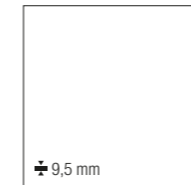

**90x90 cm Rect - 36"x36"**  
Square NATURALE PGGXT30G  
Loft NATURALE PGGXT10G  
Store NATURALE PGGXT40G  
Hangar NATURALE PGGXT00G  
Mansion NATURALE PGGXT20G  
Square EXT\* PGGXT35G  
Loft EXT\* PGGXT15G  
Mansion EXT\* PGGXT25G



**60x120 cm Rect - 24"x48"**  
Square NATURALE PGXXT30  
Loft NATURALE PGXXT10  
Store NATURALE PGXXT40  
Hangar NATURALE PGXXT00  
Mansion NATURALE PGXXT20

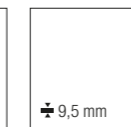

**60x60 cm Rect - 24"x24"**  
Square NATURALE PGWXT30  
Loft NATURALE PGWXT10  
Store NATURALE PGWXT40  
Hangar NATURALE PGWXT00  
Mansion NATURALE PGWXT20  
Square STRUTTURATO\* PGWXT35  
Loft STRUTTURATO\* PGWXT15  
Store STRUTTURATO\* PGWXT45  
Hangar STRUTTURATO\* PGWXT05  
Mansion STRUTTURATO\* PGWXT25



**60,3x60,3 cm - 24"x24"**  
Square NATURALE PGWXTB3  
Loft NATURALE PGWXTB1  
Store NATURALE PGWXTB4  
Hangar NATURALE PGWXTB0  
Mansion NATURALE PGWXTB2

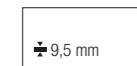

**30x60 cm Rect - 12"x24"**  
Square NATURALE PG-XT30  
Loft NATURALE PG-XT10  
Store NATURALE PG-XT40  
Hangar NATURALE PG-XT00  
Mansion NATURALE PG-XT20  
Square STRUTTURATO\* PG-XT35  
Loft STRUTTURATO\* PG-XT15  
Store STRUTTURATO\* PG-XT45  
Hangar STRUTTURATO\* PG-XT05  
Mansion STRUTTURATO\* PG-XT25

## GRES PORCELLANATO A MASSA COLORATA\_COLOURED-BODY PORCELAIN STONWARE **20 mm**

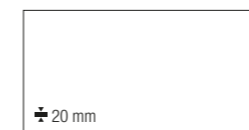

**60x120 cm Rect - 24"x48"**  
Square STRUTTURATO\* PGXXT63  
Loft STRUTTURATO\* PGXXT61  
Store STRUTTURATO\* PGXXT64  
Hangar STRUTTURATO\* PGXXT60  
Mansion STRUTTURATO\* PGXXT62

\* Protezione antibatterica non presente\_No antimicrobial protection\_Der Antibakterielle Schutz nicht vorhanden\_Protection antibactérienne pas présente

# Context

## DECORI\_DECORS

GRES PORCELLANATO A MASSA COLORATA\_COLOURED-BODY PORCELAIN STONEWARE

### SQUARE

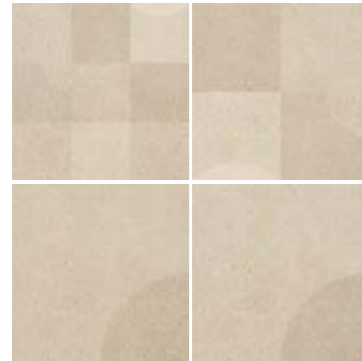

**QUARTER NATURALE**  
60x60 cm Rect - 24"x24"  
± 9,5 mm  
PGWXTQ3

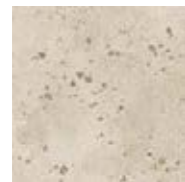

**VENICE NATURALE**  
60x60 cm Rect - 24"x24"  
± 9,5 mm  
PGWXT53



**MURETTO 3D NATURALE**  
30x60 cm Rect - 12"x24"  
± 9,5 mm  
PG-XTM3



**MOSAICO 36 PEZZI NATURALE**  
30x30 cm Rect - 12"x12"  
± 9,5 mm  
PGZXTM3

### LOFT

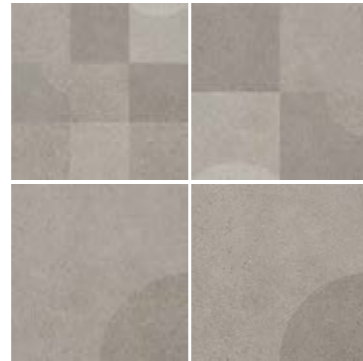

**QUARTER NATURALE**  
60x60 cm Rect - 24"x24"  
± 9,5 mm  
PGWXTQ1



**VENICE NATURALE**  
60x60 cm Rect - 24"x24"  
± 9,5 mm  
PGWXT51



**MURETTO 3D NATURALE**  
30x60 cm Rect - 12"x24"  
± 9,5 mm  
PG-XTM1

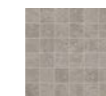

**MOSAICO 36 PEZZI NATURALE**  
30x30 cm Rect - 12"x12"  
± 9,5 mm  
PGZXTM1

### STORE

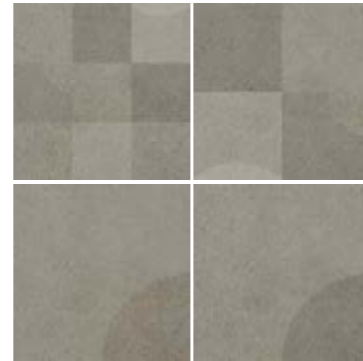

**QUARTER NATURALE**  
60x60 cm Rect - 24"x24"  
± 9,5 mm  
PGWXTQ4



**VENICE NATURALE**  
60x60 cm Rect - 24"x24"  
± 9,5 mm  
PGWXT54



**MURETTO 3D NATURALE**  
30x60 cm Rect - 12"x24"  
± 9,5 mm  
PG-XTM4



**MOSAICO 36 PEZZI NATURALE**  
30x30 cm Rect - 12"x12"  
± 9,5 mm  
PGZXTM4

### HANGAR

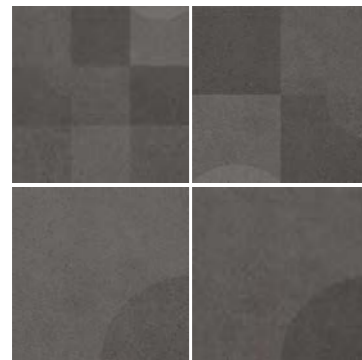

**QUARTER NATURALE**  
60x60 cm Rect - 24"x24"  
± 9,5 mm  
PGWXTQ0



**MURETTO 3D NATURALE**  
30x60 cm Rect - 12"x24"  
± 9,5 mm  
PG-XTM0

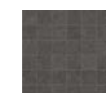

**MOSAICO 36 PEZZI NATURALE**  
30x30 cm Rect - 12"x12"  
± 9,5 mm  
PGZXTM0

### MANSION

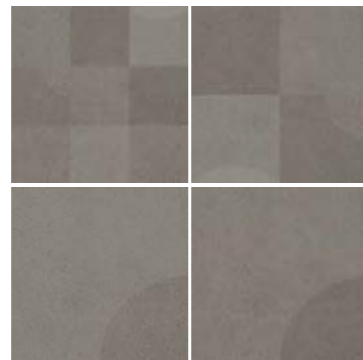

**QUARTER NATURALE**  
60x60 cm Rect - 24"x24"  
± 9,5 mm  
PGWXTQ2



**MURETTO 3D NATURALE**  
30x60 cm Rect - 12"x24"  
± 9,5 mm  
PG-XTM2



**MOSAICO 36 PEZZI NATURALE**  
30x30 cm Rect - 12"x12"  
± 9,5 mm  
PGZXTM2

**QUARTER:**  
Composizione 4 pezzi\_4 pieces composition  
4 Stück- Komposition\_Composition 4 pièces

**MURETTO 3D:**  
Posare solo a parete\_Recommended only for wall applications\_Nur an der Wand verlegen\_Recommandé seulement pour les revêtements



# Context

## PEZZI SPECIALI\_TRIM PIECES

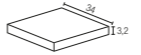
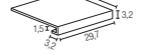
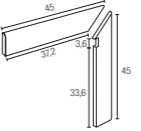
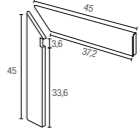
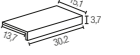
GRES PORCELLANATO A MASSA COLORATA\_COLOURED-BODY PORCELAIN STONEWARE

						
	<b>BATTISCOPA</b> 10x60 cm Rect - 4"x24" ± 10 mm NATURALE	<b>ANGOLO GRADONE A COSTA RETTA</b> 34x34 cm - 13 <sup>3/8</sup> "x13 <sup>3/8</sup> " ± 9,5 mm NATURALE	<b>GRADONE A COSTA RETTA</b> 30x34 cm Rect - 12"x13 <sup>3/8</sup> " ± 9,5 mm NATURALE	<b>BATTISCOPA SCALA DX (kit 2 pezzi)</b> 10x45 cm - 4"x18" ± 10 mm NATURALE	<b>BATTISCOPA SCALA SX (kit 2 pezzi)</b> 10x45 cm - 4"x18" ± 10 mm NATURALE	<b>ELEMENTO "L"</b> 15x30x4 cm - 6"x12"x1 <sup>9/16</sup> " ± 9 mm STRUTTURATO*
SQUARE	PGRXT30	PGEXT31	PGEXT30	PGZXT3D	PGZXT3S	PGZXTA3
LOFT	PGRXT10	PGEXT11	PGEXT10	PGZXT1D	PGZXT1S	PGZXTA1
STORE	PGRXT40	PGEXT41	PGEXT40	PGZXT4D	PGZXT4S	PGZXTA4
HANGAR	PGRXT00	PGEXT01	PGEXT00	PGZXT0D	PGZXT0S	PGZXTA0
MANSION	PGRXT20	PGEXT21	PGEXT20	PGZXT2D	PGZXT2S	PGZXTA2

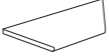
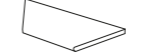
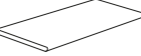
GRES PORCELLANATO A MASSA COLORATA\_COLOURED-BODY PORCELAIN STONEWARE **20 mm**

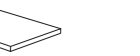



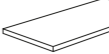
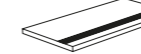
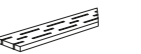
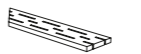
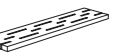

						
	<b>COSTA TORO ANGOLARE DX</b> 30x60 cm Rect - 12"x24" STRUTTURATO*	<b>COSTA TORO ANGOLARE SX</b> 30x60 cm Rect - 12"x24" STRUTTURATO*	<b>COSTA TORO</b> 30x60 cm Rect - 12"x24" STRUTTURATO*	<b>COSTA TORO GRIP</b> 30x60 cm Rect - 12"x24" STRUTTURATO*	<b>COSTA RETTA ANGOLARE DX</b> 30x60 cm Rect - 12"x24" STRUTTURATO*	<b>COSTA RETTA ANGOLARE SX</b> 30x60 cm Rect - 12"x24" STRUTTURATO*
SQUARE	PGDXTK3	PGDXTK7	PGDXTF3	PGDXTJ3	PGDXTD3	PGDXTD7
LOFT	PGDXTK1	PGDXTK9	PGDXTF1	PGDXTJ1	PGDXTD1	PGDXTD9
STORE	PGDXTK4	PGDXTK8	PGDXTF4	PGDXTJ4	PGDXTD4	PGDXTD8
HANGAR	PGDXTK0	PGDXTK5	PGDXTF0	PGDXTJ0	PGDXTD0	PGDXTD5
MANSION	PGDXTK2	PGDXTK6	PGDXTF2	PGDXTJ2	PGDXTD2	PGDXTD6

					
	<b>COSTA RETTA</b> 30x60 cm Rect - 12"x24" STRUTTURATO*	<b>COSTA RETTA GRIP</b> 30x60 cm Rect - 12"x24" STRUTTURATO*	<b>GRIGLIA ANGOLARE DX</b> 15x60 cm Rect - 6"x24" STRUTTURATO*	<b>GRIGLIA ANGOLARE SX</b> 15x60 cm Rect - 6"x24" STRUTTURATO*	<b>GRIGLIA</b> 15x60 cm Rect - 6"x24" STRUTTURATO*
SQUARE	PGDXTC3	PGDXTG3	PG1XTA3	PG1XTA7	PG1XTZ3
LOFT	PGDXTC1	PGDXTG1	PG1XTA1	PG1XTA9	PG1XTZ1
STORE	PGDXTC4	PGDXTG4	PG1XTA4	PG1XTA8	PG1XTZ4
HANGAR	PGDXTC0	PGDXTG0	PG1XTA0	PG1XTA5	PG1XTZ0
MANSION	PGDXTC2	PGDXTG2	PG1XTA2	PG1XTA6	PG1XTZ2

\* Protezione antibatterica non presente\_No antimicrobial protection\_Der Antibakterielle Schutz nicht vorhanden\_Protection antibactérienne pas présente

## IMBALLAGGI E PESI\_PACKINGS AND WEIGHTS

DESCRIZIONE Description	± mm	FORMATI Sizes	SCATOLA_Box				PALLET			
										
FONDO NATURALE	6	120x260 <sup>RECT</sup>	1	44	3,12	-	18	792	56,16	
FONDO NATURALE	6	120x120 <sup>RECT</sup>	2	40,6	2,88	-	25	1015	72	
FONDO NATURALE	9,5	60x120 <sup>RECT</sup>	2	31,8	1,44	-	36	1144,8	51,84	
FONDO NATURALE / EXT	9,5	90x90 <sup>RECT</sup>	2	33,6	1,62	-	25	840	40,5	
FONDO NATURALE / STRUTTURATO	9,5	60x60 <sup>RECT</sup>	4	31,8	1,44	-	32	1017,6	46,08	
FONDO NATURALE	9,5	60,3x60,3	4	31,8	1,454	-	32	1017,6	46,54	
FONDO NATURALE / STRUTTURATO	9,5	30x60 <sup>RECT</sup>	8	31,8	1,44	-	32	1017,6	46,08	
MOSAICO 36 PEZZI NATURALE	9,5	30x30 <sup>RECT</sup>	4	7,31	0,36	-	78	570,57	28,08	
MURETTO 3D NATURALE	9,5	30x60 <sup>RECT</sup>	4	15,7	0,72	-	18	282,6	12,96	
VENICE NATURALE	9,5	60x60 <sup>RECT</sup>	4	31,8	1,44	-	32	1017,6	46,08	
QUARTER NATURALE	9,5	60x60 <sup>RECT</sup>	4	31,8	1,44	-	26	826,8	37,44	
BATTISCOPA NATURALE	10	10x60 <sup>RECT</sup>	12	15	0,72	7,2	60	900	43,2	
BATTISCOPA SCALA (KIT 2 PZ.) NATURALE	10	10x45	5	8,5	0,425	-	-	-	-	
GRADONE A COSTA RETTA NATURALE	9,5	30x34 <sup>RECT</sup>	6	17,1	0,612	-	30	513	18,36	
ANGOLO GRADONE A COSTA RETTA NATURALE	9,5	34x34	2	6,27	0,231	-	48	300,96	11,09	
ELEMENTO "L" STRUTTURATO	9	15x30x4	8	9,6	0,36	2,4	48	460,8	17,28	
FONDO STRUTTURATO	20	60x120 <sup>RECT</sup>	1	32,5	0,72	-	32	1040	23,04	
COSTA TORO STRUTTURATO	20	30x60 <sup>RECT</sup>	1	8,125	0,18	-	100	812,5	18	
COSTA TORO ANGOLARE STRUTTURATO	20	30x60 <sup>RECT</sup>	1	6,1	0,135	-	100	610	13,5	
COSTA TORO GRIP STRUTTURATO	20	30x60 <sup>RECT</sup>	1	8,125	0,18	-	100	812,5	18	
COSTA RETTA STRUTTURATO	20	30x60 <sup>RECT</sup>	1	8,125	0,18	-	100	812,5	18	
COSTA RETTA ANGOLARE STRUTTURATO	20	30x60 <sup>RECT</sup>	1	6,1	0,135	-	100	610	13,5	
COSTA RETTA GRIP STRUTTURATO	20	30x60 <sup>RECT</sup>	1	8,125	0,18	-	100	812,5	18	
GRIGLIA STRUTTURATO	20	15x60 <sup>RECT</sup>	2	8	0,18	-	100	800	18	
GRIGLIA ANGOLARE STRUTTURATO	20	15x60 <sup>RECT</sup>	2	7	0,157	-	100	700	15,75	



# Experience



BIANCO DENSO



BEIGE TENUE



GRIGIO VIVO



NERO PURO

GRES PORCELLANATO LAMINATO\_LAMINATED PORCELAIN STONEWARE **Zero.3**



± 3,5 mm



100x300 cm Rect  
39"x118"



100x100 cm Rect  
39"x39"



50x100 cm Rect  
19 1/2"x39"



50x50 cm Rect  
19 1/2"x19 1/2"



RIVESTIMENTO / WALL Beige Tenue Naturale 100x100 cm Rect - 39"x39" \_Nero Puro Naturale 100x300 cm Rect - 39"x118"  
 PAVIMENTO / FLOOR Nero Puro Naturale 100x100 cm Rect - 39"x39"



RIVESTIMENTO / WALL Beige Tenue Naturale 100x300 cm Rect - 39"x118" \_Mosaico A Beige Tenue Naturale 50x50 cm Rect - 19 1/2"x19 1/2"  
 PAVIMENTO / FLOOR Beige Tenue Naturale 100x300 cm Rect - 39"x118"

# Experience

BIANCO DENSO



BEIGE TENUE



GRIGIO VIVO

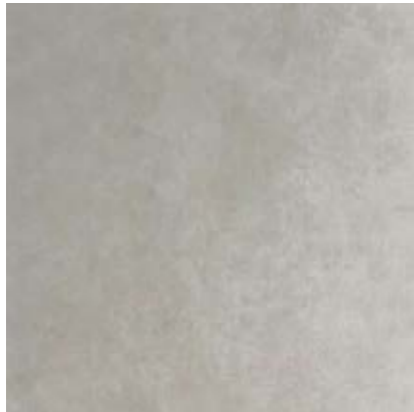

NERO PURO



# Experience

GRES PORCELLANATO LAMINATO\_LAMINATED PORCELAIN STONEWARE **Zero.3**

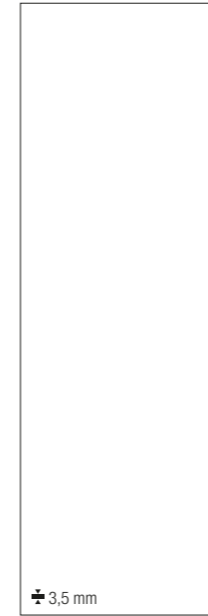

100x300 cm Rect - 39"x118"

Bianco Denso NATURALE PG7EX055  
 Beige Tenue NATURALE PG7EX155  
 Grigio Vivo NATURALE PG7EX255  
 Nero Puro NATURALE PG7EX355



100x100 cm Rect - 39"x39"

Bianco Denso NATURALE PG8EX05  
 Beige Tenue NATURALE PG8EX15  
 Grigio Vivo NATURALE PG8EX25  
 Nero Puro NATURALE PG8EX35

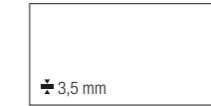

50x100 cm Rect - 19<sup>1</sup>/<sub>2</sub>"x39"

Bianco Denso NATURALE PG9EX05  
 Beige Tenue NATURALE PG9EX15  
 Grigio Vivo NATURALE PG9EX25  
 Nero Puro NATURALE PG9EX35



50x50 cm Rect - 19<sup>1</sup>/<sub>2</sub>"x19<sup>1</sup>/<sub>2</sub>"

Bianco Denso NATURALE PGVEX05  
 Beige Tenue NATURALE PGVEX15  
 Grigio Vivo NATURALE PGVEX25  
 Nero Puro NATURALE PGVEX35

DESTINAZIONI D'USO\_INTENDED USE: NATURALE

DATI TECNICI\_TECHNICAL DATA:

GRES PORCELLANATO LAMINATO  
 LAMINATED PORCELAIN STONEWARE

3,5 mm

DIN 51130: R9 Naturale

ANSI A137.3: V2 Naturale

# Experience

## DECORI\_DECORS

GRES PORCELLANATO LAMINATO\_LAMINATED PORCELAIN STONEWARE **Zero.3**

### BIANCO DENSO



**MOSAICO A NATURALE**  
50x50 cm Rect - 19<sup>1/2</sup>"x19<sup>1/2</sup>"  
± 3 mm  
PGZEX00



**MOSAICO B NATURALE**  
25x25 cm Rect - 10"x10"  
± 3 mm  
PGZEX10

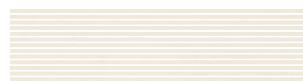

**MOSAICO C NATURALE**  
25x100 cm Rect - 10"x39"  
± 3 mm  
PGZEX20

### BEIGE TENUE



**MOSAICO A NATURALE**  
50x50 cm Rect - 19<sup>1/2</sup>"x19<sup>1/2</sup>"  
± 3 mm  
PGZEX01



**MOSAICO B NATURALE**  
25x25 cm Rect - 10"x10"  
± 3 mm  
PGZEX11

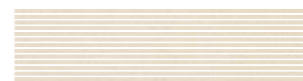

**MOSAICO C NATURALE**  
25x100 cm Rect - 10"x39"  
± 3 mm  
PGZEX21

### GRIGIO VIVO



**MOSAICO A NATURALE**  
50x50 cm Rect - 19<sup>1/2</sup>"x19<sup>1/2</sup>"  
± 3 mm  
PGZEX02



**MOSAICO B NATURALE**  
25x25 cm Rect - 10"x10"  
± 3 mm  
PGZEX12



**MOSAICO C NATURALE**  
25x100 cm Rect - 10"x39"  
± 3 mm  
PGZEX22

### NERO PURO

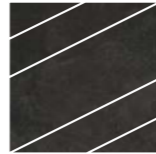

**MOSAICO A NATURALE**  
50x50 cm Rect - 19<sup>1/2</sup>"x19<sup>1/2</sup>"  
± 3 mm  
PGZEX03



**MOSAICO B NATURALE**  
25x25 cm Rect - 10"x10"  
± 3 mm  
PGZEX13



**MOSAICO C NATURALE**  
25x100 cm Rect - 10"x39"  
± 3 mm  
PGZEX23

#### MOSAICO A, MOSAICO B, MOSAICO C:

Posare solo a parete\_Recommended only for wall applications\_Nur an der Wand verlegen\_Recommandé seulement pour les revêtements

# Experience

## DECORI\_DECORS

GRES PORCELLANATO LAMINATO\_LAMINATED PORCELAIN STONEWARE **Zero.3**

### FLORA



**FLORA A**  
100x100 cm Rect - 39"x39"  
± 3,5 mm  
PG8EXFA



**FLORA B**  
100x100 cm Rect - 39"x39"  
± 3,5 mm  
PG8EXFB



**FLORA C**  
100x100 cm Rect - 39"x39"  
± 3,5 mm  
PG8EXFC



**FLORA E**  
100x100 cm Rect - 39"x39"  
± 3,5 mm  
PG8EXFE

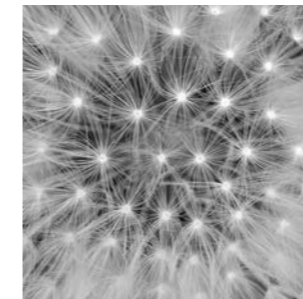

**FLORA D**  
100x100 cm Rect - 39"x39"  
± 3,5 mm  
PG8EXFD

#### FLORA:

Rivestimenti decorati da interno\_Interior decorated wall coverings\_Dekorierter Wandbeleg für Innenbereich\_Décor pour revêtement mural intérieur

I decori Flora sono realizzati mediante la tecnologia di stampa digitale a freddo, che permette di raggiungere risultati estetici e cromatici di eccezionale qualità. Le grafiche vengono impresse ad altissima risoluzione sul supporto ceramico, mantenendo invariati i colori brillanti e le sfumature dei motivi decorativi\_Flora decors are made using digital cold printing technology, with which aesthetic, chromatic results of exceptional quality are achieved. The graphics are imprinted at very high resolution on the ceramic substrate, keeping the brilliant colors and shades of the decorative designs unchanged\_Die Flora-Dekore werden mit der kalten Digitaldrucktechnologie hergestellt, die es ermöglicht, ästhetische und chromatische Ergebnisse von außergewöhnlicher Qualität zu erzielen. Die Grafiken werden in sehr hoher Auflösung auf den Keramikträger gedruckt, wobei die brillanten Farben und Schattierungen der dekorativen Motive unverändert bleiben\_Les décors Flora sont réalisés grâce à la technologie d'impression numérique à froid, qui permet d'obtenir des résultats esthétiques et chromatiques d'une qualité exceptionnelle. Les graphismes sont imprimés en haute résolution sur le support céramique, en préservant la brillance des couleurs et les nuances des motifs décoratifs

Le dimensioni dei decori sono personalizzabili\_Decors dimensions can be customized\_Das Format der Dekoren ist auf Wunsch realisierbar\_La dimension des décors peut être personnalisée

Attenzione: per la pulizia dei decori attenersi scrupolosamente alle istruzioni riportate a pagina 413\_Notice: for decors cleaning you should follow carefully the instructions provided on page 413\_Achtung: für die Reinigung sich genau auf die Anleitungen auf der Seite 413 halten\_Attention: pour le nettoyage des décors il faut suivre scrupuleusement les renseignements contenus à page 413

## IMBALLAGGI E PESI\_PACKINGS AND WEIGHTS

DESCRIZIONE Description	± mm	FORMATI Sizes	SCATOLA_Box				PALLET		
FONDO NATURALE	3,5	100x300 <sup>RECT</sup>	1	23,4	3	-	20	468	60
FONDO NATURALE	3,5	100x100 <sup>RECT</sup>	3	23,4	3	-	25	585	75
FONDO NATURALE	3,5	50x100 <sup>RECT</sup>	5	19,5	2,5	-	32	624	80
FONDO NATURALE	3,5	50x50 <sup>RECT</sup>	7	13,65	1,75	-	48	655	84
MOSAICO A NATURALE	3	50x50 <sup>RECT</sup>	3	5,25	0,75	-	-	-	-
MOSAICO B NATURALE	3	25x25 <sup>RECT</sup>	6	2,7	0,375	-	-	-	-
MOSAICO C NATURALE	3	25x100 <sup>RECT</sup>	3	5,25	0,75	-	-	-	-
FLORA	3,5	100x100 <sup>RECT</sup>	1	7,8	1	-	-	-	-



# Genesis

Fiordo



BIRTH



SOUL



ROOT



GLOAM

GRES PORCELLANATO A MASSA COLORATA\_COLOURED-BODY PORCELAIN STONEWARE



± 9,5 mm



60x60 cm Rect  
24"x24"  
60,3x60,3 cm  
24"x24"



30x60 cm Rect  
12"x24"





PAVIMENTO / FLOOR Soul Naturale 60x60 cm Rect - 24"x24"

# Genesis

BIRTH



SOUL



ROOT



GLOAM



DESTINAZIONI D'USO\_INTENDED USE: NATURALE

DATI TECNICI\_TECHNICAL DATA:

**GRES PORCELLANATO A MASSA COLORATA**  
COLOURED-BODY PORCELAIN STONEWARE

± 9,5 mm

DIN 51130: **R10** Naturale  
BCR TORTUS:  $\mu > 0,40$  Naturale  
ANSI A326.3: **DCOF  $\geq 0,42$**  Naturale

ANSI A137.1: **V2** Naturale

# Genesis

**GRES PORCELLANATO A MASSA COLORATA\_COLOURED-BODY PORCELAIN STONEWARE**



60x60 cm Rect - 24"x24"

Birth NATURALE FGWGSR0  
Soul NATURALE FGWGSR3  
Root NATURALE FGWGSR2  
Gloam NATURALE FGWGSR1

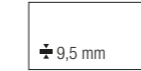

30x60 cm Rect - 12"x24"

Birth NATURALE FG-GSR0  
Soul NATURALE FG-GSR3  
Root NATURALE FG-GSR2  
Gloam NATURALE FG-GSR1

60,3x60,3 cm - 24"x24"

Birth NATURALE FGWGS00  
Soul NATURALE FGWGS30  
Root NATURALE FGWGS20  
Gloam NATURALE FGWGS10

**PEZZI SPECIALI\_TRIM PIECES**

**GRES PORCELLANATO A MASSA COLORATA\_COLOURED-BODY PORCELAIN STONEWARE**

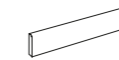

**BATTISCOPA**  
10x60 cm Rect - 4"x24"  
± 10 mm  
NATURALE

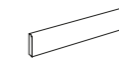

**BATTISCOPA**  
10x60,3 cm - 4"x24"  
± 10 mm  
NATURALE

	FGRGSR0	FGRGS00
BIRTH	FGRGSR0	FGRGS00
SOUL	FGRGSR3	FGRGS30
ROOT	FGRGSR2	FGRGS20
GLOAM	FGRGSR1	FGRGS10

**IMBALLAGGI E PESI\_PACKINGS AND WEIGHTS**

DESCRIZIONE Description	± mm	FORMATI Sizes	SCATOLA_Box				PALLET		
FONDO NATURALE	9,5	60x60 RECT	4	31,8	1,44	-	32	1018	46,1
FONDO NATURALE	9,5	60,3x60,3	4	31,8	1,45	-	32	1018	46,5
FONDO NATURALE	9,5	30x60 RECT	8	31,8	1,44	-	32	1018	46,1
BATTISCOPA NATURALE	10	10x60 RECT	11	15	0,66	6,6	60	900	396
BATTISCOPA NATURALE	10	10x60,3	16	20	0,9648	9,648	48	960	46,31



# Memory Mood



CREAMY



HAZEL



COPPER



SHEER



DIM



KEEN

GRES PORCELLANATO A MASSA COLORATA\_COLOURED-BODY PORCELAIN STONEWARE



± 9 mm  
± 9,5 mm



90x90 cm Rect  
36"x36"



60x60 cm Rect  
24"x24"  
60,3x60,3 cm  
24"x24"



30x60,3 cm  
12"x24"



20x20 cm  
8"x8"

GRES PORCELLANATO A MASSA COLORATA\_COLOURED-BODY PORCELAIN STONEWARE **20 mm**



± 20 mm



60x60 cm Rect  
24"x24"  
60,3x60,3 cm  
24"x24"



PAVIMENTO / FLOOR Dim Naturale 60,3x60,3 cm - 24"x24"



PAVIMENTO / FLOOR Hazel Naturale 60,3x60,3 cm - 24"x24"



PAVIMENTO / FLOOR Keen Naturale 60,3x60,3 cm - 24"x24"



RIVESTIMENTO / WALL Assi d'Alpe Stube Naturale 20x90,5 cm - 8"x36"  
PAVIMENTO / FLOOR Sheer Naturale 20x20 cm - 8"x8" \_Decor Mood 1 Naturale 20x20 cm - 8"x8"

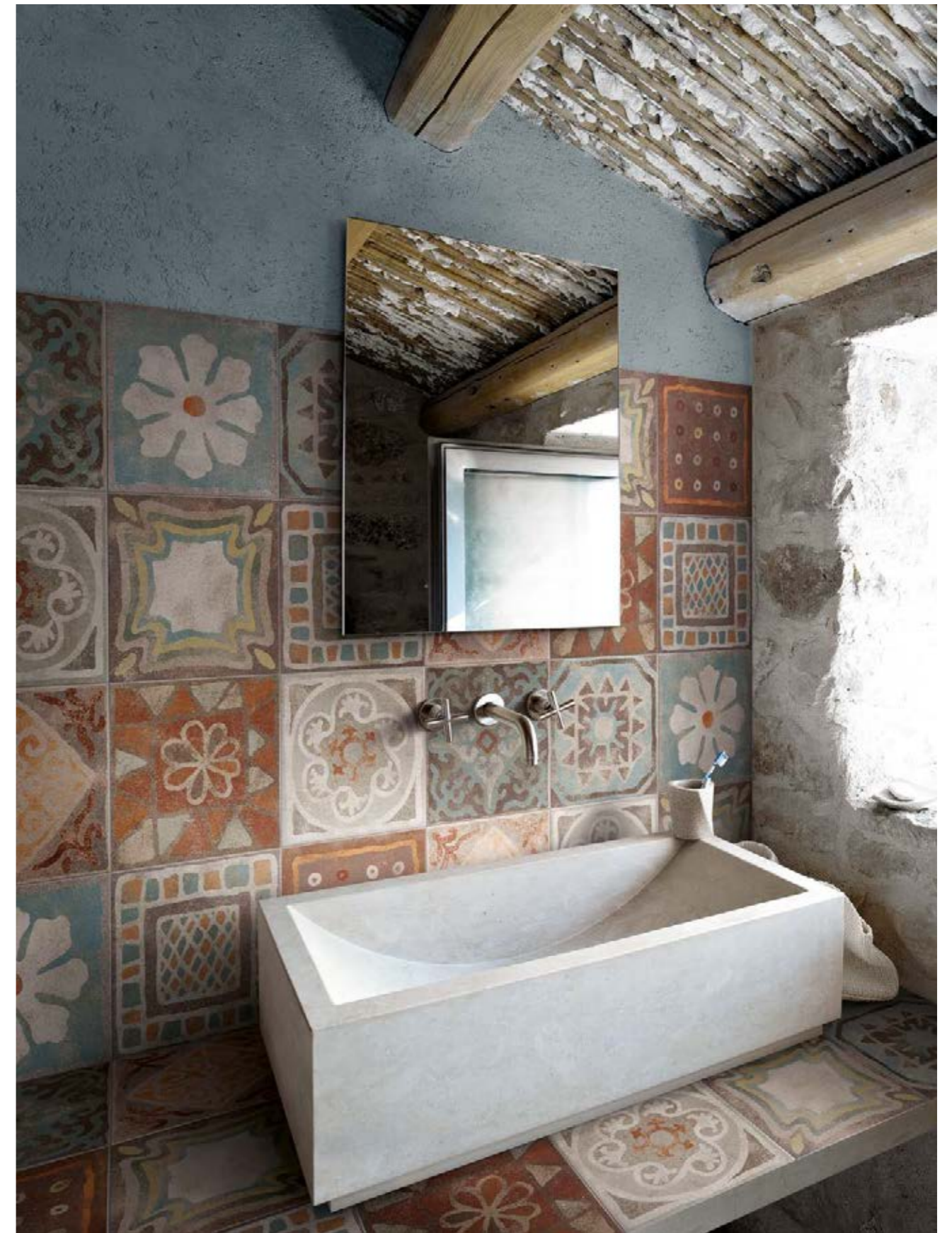

RIVESTIMENTO / WALL Decor Mood Mix Naturale 20x20 cm - 8"x8"



PAVIMENTO / FLOOR Hazel Strutturato 60,3x60,3 cm - 24"x24" 20 mm\_Decor Mood 5 Naturale 20x20 cm - 8"x8"

# Memory Mood

CREAMY



HAZEL



COPPER



SHEER



DIM



KEEN



# Memory Mood

GRES PORCELLANATO A MASSA COLORATA\_COLOURED-BODY PORCELAIN STONEWARE



90x90 cm Rect - 36"x36"

Creamy NATURALE PGGME10G  
Copper NATURALE PGGME00G  
Sheer NATURALE PGGME50G  
Dim NATURALE PGGME20G  
Keen NATURALE PGGME40G

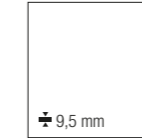

60x60 cm Rect - 24"x24"

Creamy NATURALE PGWMER1  
Hazel NATURALE PGWMER3  
Copper NATURALE PGWME00  
Sheer NATURALE PGWMER5  
Dim NATURALE PGWMER2  
Keen NATURALE PGWMER4

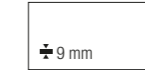

30x60,3 cm - 12"x24"

Creamy NATURALE PG-ME10  
Hazel NATURALE PG-ME30  
Copper NATURALE PG-ME00  
Sheer NATURALE PG-ME50  
Dim NATURALE PG-ME20  
Keen NATURALE PG-ME40



20x20 cm - 8"x8"

Creamy NATURALE PGEME10  
Hazel NATURALE PGEME30  
Copper NATURALE PGEME00  
Sheer NATURALE PGEME50  
Dim NATURALE PGEME20  
Keen NATURALE PGEME40

60,3x60,3 cm - 24"x24"

Creamy NATURALE PGWME10  
Hazel NATURALE PGWME30  
Copper NATURALE PGWME00  
Sheer NATURALE PGWME50  
Dim NATURALE PGWME20  
Keen NATURALE PGWME40

GRES PORCELLANATO A MASSA COLORATA\_COLOURED-BODY PORCELAIN STONEWARE **20 mm**

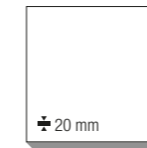

60x60 cm Rect - 24"x24"

Hazel STRUTTURATO PGWMET3  
Dim STRUTTURATO PGWMET2

60,3x60,3 cm - 24"x24"

Hazel STRUTTURATO PGWMES3  
Dim STRUTTURATO PGWMES2

DESTINAZIONI D'USO\_INTENDED USE: NATURALE STRUTTURATO

DATI TECNICI\_TECHNICAL DATA:

GRES PORCELLANATO A MASSA COLORATA COLOURED-BODY PORCELAIN STONEWARE	GRES PORCELLANATO A MASSA COLORATA COLOURED-BODY PORCELAIN STONEWARE
9 / 9,5 mm	20 mm
DIN 51130: R10 Naturale DIN 51097: B (A+B) Naturale BCR TORTUS: $\mu > 0,40$ Naturale ANSI A326.3: DCOF $\geq 0,42$ Naturale UNE 41901 EX: Classe 2 Naturale	DIN 51130: R11 Strutturato DIN 51097: C (A+B+C) Strutturato BCR TORTUS: $\mu > 0,40$ Strutturato ANSI A326.3: DCOF $\geq 0,42$ Strutturato AS/NZS 4586: P4 Strutturato BS 7976-2: PTV 36+WET (Sl.96 - Sl.55) Strutturato UNE 41901 EX: Classe 3 Strutturato
ANSI A137.1: V3 Naturale	ANSI A137.1: V3 Strutturato



# Memory Mood

## DECORI\_DECORS

GRES PORCELLANATO A MASSA COLORATA\_COLOURED-BODY PORCELAIN STONWARE

### COMPOSIZIONE DI 9 PEZZI\_9 PIECES COMPOSITION

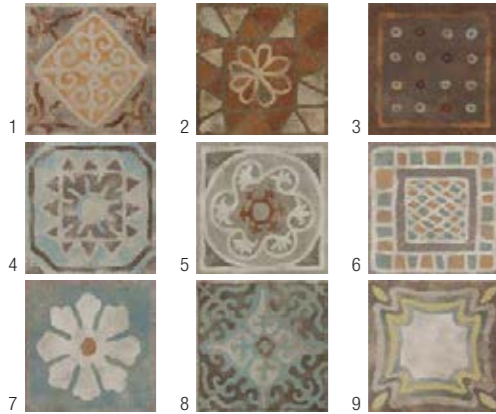

DECOR MOOD  
20x20 cm - 8"x8"  
± 9 mm

- Decor Mood 1 PGEMED1
- Decor Mood 2 PGEMED2
- Decor Mood 3 PGEMED3
- Decor Mood 4 PGEMED4
- Decor Mood 5 PGEMED5
- Decor Mood 6 PGEMED6
- Decor Mood 7 PGEMED7
- Decor Mood 8 PGEMED8
- Decor Mood 9 PGEMED9



DECOR MOOD MIX  
20x20 cm - 8"x8"  
± 9 mm

PGEMEDM

# Memory Mood

## PEZZI SPECIALI\_TRIM PIECES

GRES PORCELLANATO A MASSA COLORATA\_COLOURED-BODY PORCELAIN STONWARE

	BATTISCOPIA 10x60 cm Rect - 4"x24" ± 10 mm NATURALE	BATTISCOPIA 10x60,3 cm - 4"x24" ± 10 mm NATURALE	ANGOLO GRADONE A COSTA RETTA 34x34 cm - 13 <sup>38</sup> °x13 <sup>38</sup> ° ± 9,5 mm NATURALE	GRADONE A COSTA RETTA 30x34 cm Rect - 12"x13 <sup>38</sup> ° ± 9,5 mm NATURALE	BATTISCOPIA SCALA DX (kit 2 pezzi) 10x45 cm - 4"x18" ± 10 mm NATURALE	BATTISCOPIA SCALA SX (kit 2 pezzi) 10x45 cm - 4"x18" ± 10 mm NATURALE
CREAMY	PGRME11	PGRME10	PGEME11	PGEME10	PGZME1D	PGZME1S
HAZEL	PGRME31	PGRME30	PGEME31	PGEME30	PGZME3D	PGZME3S
COPPER	PGRME01	PGRME00	PGEME01	PGEME00	PGZME0D	PGZME0S
SHEER	PGRME51	PGRME50	PGEME51	PGEME50	PGZME5D	PGZME5S
DIM	PGRME21	PGRME20	PGEME21	PGEME20	PGZME2D	PGZME2S
KEEN	PGRME41	PGRME40	PGEME41	PGEME40	PGZME4D	PGZME4S

GRES PORCELLANATO A MASSA COLORATA\_COLOURED-BODY PORCELAIN STONWARE **20 mm**

	COSTA TORO ANGOLARE DX 30x60 cm Rect - 12"x24" STRUTTURATO	COSTA TORO ANGOLARE SX 30x60 cm Rect - 12"x24" STRUTTURATO	COSTA TORO 30x60 cm Rect - 12"x24" STRUTTURATO	COSTA TORO GRIP 30x60 cm Rect - 12"x24" STRUTTURATO	COSTA RETTA ANGOLARE DX 30x60 cm Rect - 12"x24" STRUTTURATO	COSTA RETTA ANGOLARE SX 30x60 cm Rect - 12"x24" STRUTTURATO
HAZEL	PGDMEK6	PGDMEK5	PGDMEF3	PGDMEJ3	PGDMED6	PGDMED5
DIM	PGDMEK3	PGDMEK2	PGDMEF2	PGDMEJ2	PGDMED3	PGDMED2

	COSTA RETTA 30x60 cm Rect - 12"x24" STRUTTURATO	COSTA RETTA GRIP 30x60 cm Rect - 12"x24" STRUTTURATO	GRIGLIA ANGOLARE DX 15x60 cm Rect - 6"x24" STRUTTURATO	GRIGLIA ANGOLARE SX 15x60 cm Rect - 6"x24" STRUTTURATO	GRIGLIA 15x60 cm Rect - 6"x24" STRUTTURATO
HAZEL	PGDMEC3	PGDMEG3	PGDMEA6	PGDMEA5	PGDMEZ3
DIM	PGDMEC2	PGDMEG2	PGDMEA3	PGDMEA2	PGDMEZ2

## IMBALLAGGI E PESI\_PACKINGS AND WEIGHTS

DESCRIZIONE Description	± mm	FORMATI Sizes	SCATOLA_Box				PALLET		
FONDO NATURALE	9,5	90x90 <sup>RECT</sup>	2	33,6	1,62	-	25	840	40,5
FONDO NATURALE	9,5	60x60 <sup>RECT</sup>	4	31,8	1,44	-	32	1018	46,1
FONDO NATURALE	9,5	60,3x60,3	4	31,8	1,45	-	32	1018	46,5
FONDO NATURALE	9	30x60,3	9	33,45	1,628	-	32	1070,4	52,1
FONDO NATURALE	9	20x20	30	25	1,2	-	45	1125	54
DECOR MOOD NATURALE	9	20x20	30	25	1,2	-	45	1125	54
DECOR MOOD MIX NATURALE	9	20x20	9	6,9	0,36	-	30	207	10,8
BATTISCOPIA NATURALE	10	10x60 <sup>RECT</sup>	12	15,48	0,72	7,2	60	929	43,2
BATTISCOPIA NATURALE	10	10x60,3	16	20	0,9648	9,648	48	960	46,31
BATTISCOPIA SCALA (KIT 2 PZ.) NATURALE	10	10x45	5	8,5	0,4	-	-	-	-
GRADONE A COSTA RETTA NATURALE	9,5	30x34 <sup>RECT</sup>	6	17,5	0,61	-	30	524	18,4
ANGOLO GRADONE A COSTA RETTA NATURALE	9,5	34x34	2	6,3	0,23	-	48	301	11,1
FONDO STRUTTURATO	20	60x60 <sup>RECT</sup>	2	33	0,72	-	32	1056	23,04
FONDO STRUTTURATO	20	60,3x60,3	2	33,3	0,73	-	32	1065,6	23,27
COSTA TORO STRUTTURATO	20	30x60 <sup>RECT</sup>	1	8,125	0,135	-	100	813	13,5
COSTA TORO ANGOLARE STRUTTURATO	20	30x60 <sup>RECT</sup>	1	6,1	0,135	-	100	610	13,5
COSTA TORO GRIP STRUTTURATO	20	30x60 <sup>RECT</sup>	1	8,125	0,135	-	100	813	13,5
COSTA RETTA STRUTTURATO	20	30x60 <sup>RECT</sup>	1	8,125	0,135	-	100	813	13,5
COSTA RETTA ANGOLARE STRUTTURATO	20	30x60 <sup>RECT</sup>	1	6,1	0,135	-	100	610	13,5
COSTA RETTA GRIP STRUTTURATO	20	30x60 <sup>RECT</sup>	1	8,125	0,135	-	100	813	13,5
GRIGLIA STRUTTURATO	20	15x60 <sup>RECT</sup>	2	8	0,158	-	100	800	15,75
GRIGLIA ANGOLARE STRUTTURATO	20	15x60 <sup>RECT</sup>	2	7	0,158	-	100	700	15,75



# Motion

Fiordo



CLEAR



LAND



MID



DUN



CARBON

GRES PORCELLANATO SMALTATO \_ GLAZED PORCELAIN STONEWARE



± 9,5 mm



60x60 cm Rect  
24"x24"



30x60 cm Rect  
12"x24"



PAVIMENTO / FLOOR Mid Naturale 60x60 cm Rect - 24"x24"



PAVIMENTO / FLOOR Clear Naturale 60x60 cm Rect - 24"x24"

# Motion

CLEAR



LAND



MID



DUN





CARBON



DESTINAZIONI D'USO\_INTENDED USE: NATURALE   

DATI TECNICI\_TECHNICAL DATA:

<b>GRES PORCELLANATO SMALTATO</b> GLAZED PORCELAIN STONEWARE	
<b>+</b>	9,5 mm
	DIN 51130: <b>R9</b> Naturale BCR TORTUS: $\mu > 0,40$ Naturale ANSI A326.3: <b>DCOF</b> $\geq 0,42$ Naturale ISO 10545-7: <b>PEI 5</b> Clear, Mid - Naturale <b>PEI 4</b> Land, Dun, Carbon - Naturale
	ANSI A137.1: <b>V3</b> Naturale

# Motion

GRES PORCELLANATO SMALTATO\_GLAZED PORCELAIN STONEWARE

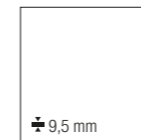

60x60 cm Rect - 24"x24"

Clear NATURALE FGWMNR0  
Land NATURALE FGWMNR2  
Mid NATURALE FGWMNR3  
Dun NATURALE FGWMNR1  
Carbon NATURALE FGWMNR4



30x60 cm Rect - 12"x24"

Clear NATURALE FG-MNR0  
Land NATURALE FG-MNR2  
Mid NATURALE FG-MNR3  
Dun NATURALE FG-MNR1  
Carbon NATURALE FG-MNR4

PEZZI SPECIALI\_TRIM PIECES



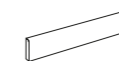



GRES PORCELLANATO SMALTATO\_GLAZED PORCELAIN STONEWARE



**BATTISCOPA**  
10x60 cm Rect - 4"x24"  
+ 10 mm  
NATURALE

CLEAR	<b>FGRMNR0</b>
LAND	<b>FGRMNR2</b>
MID	<b>FGRMNR3</b>
DUN	<b>FGRMNR1</b>
CARBON	<b>FGRMNR4</b>

IMBALLAGGI E PESI\_PACKINGS AND WEIGHTS

DESCRIZIONE Description	+ mm	FORMATI Sizes	SCATOLA_Box				PALLET		
									
<b>FONDO</b> NATURALE	9,5	60x60 RECT	4	31,8	1,44	-	32	1018	46,1
<b>FONDO</b> NATURALE	9,5	30x60 RECT	8	31,8	1,44	-	32	1018	46,1
<b>BATTISCOPA</b> NATURALE	10	10x60 RECT	12	16,4	0,72	7,2	60	984	43,2



# Opificio 22/a



GESSO



CALCE



ARGILLA



TERRA



CENERE

GRES PORCELLANATO A MASSA COLORATA\_COLOURED-BODY PORCELAIN STONEWARE



± 9,5 mm  
± 8 mm



90x90 cm Rect  
36"x36"



60x60 cm Rect  
24"x24"



30x60 cm Rect  
12"x24"



20x20 cm  
8"x8"

GRES PORCELLANATO A MASSA COLORATA\_COLOURED-BODY PORCELAIN STONEWARE **20 mm**



± 20 mm

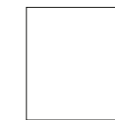

90x90 cm Rect  
36"x36"

RIVESTIMENTO / WALL Trame Mix Naturale 20x20 cm - 8"x8"  
PAVIMENTO / FLOOR Terra Naturale 90x90 cm Rect - 36"x36" Trame Mix Naturale 20x20 cm - 8"x8"  
Terra Ext 60x60 cm Rect - 24"x24"



RIVESTIMENTO / WALL Gesso Naturale 60x60 cm Rect - 24"x24" \_Muretto Gesso Naturale 30x60 cm Rect - 12"x24"  
PAVIMENTO / FLOOR Terra Naturale 60x60 cm Rect - 24"x24"



RIVESTIMENTO / WALL Cenero Naturale 20x20 cm - 8"x8" \_Trame Scuro Naturale 20x20 cm - 8"x8" \_Gesso Naturale 20x20 cm - 8"x8"  
 PAVIMENTO / FLOOR Cenero Naturale 60x60 cm Rect - 24"x24" \_Trame Scuro Naturale 20x20 cm - 8"x8"



RIVESTIMENTO / WALL Argilla Naturale 20x20 cm - 8"x8" \_Trame Chiaro Naturale 20x20 cm - 8"x8"  
 PAVIMENTO / FLOOR Argilla Naturale 60x60 cm Rect - 24"x24" \_Trame Chiaro Naturale 20x20 cm - 8"x8"





RIVESTIMENTO / WALL Muretto Calce Naturale 30x60 cm Rect - 12"x24"  
PAVIMENTO / FLOOR Calce Naturale 90x90 cm Rect - 36"x36"



PAVIMENTO / FLOOR Cenere Naturale 60x60 cm Rect - 24"x24" \_Quadri Scuro Naturale 20x20 cm - 8"x8"



PAVIMENTO / FLOOR Calce Strutturato 90x90 cm Rect - 36"x36" 20 mm

# Opificio 22/a

**PROTECT**  
ANTIBATTERICO - ANTIMICROBIAL

## GESSO



## CALCE



## ARGILLA



## TERRA



## CENERE



# Opificio 22/a

## GRES PORCELLANATO A MASSA COLORATA\_COLOURED-BODY PORCELAIN STONEWARE



90x90 cm Rect - 36"x36"

Gesso NATURALE PGG2A30G  
Calce NATURALE PGG2A10G  
Argilla NATURALE PGG2A00G  
Terra NATURALE PGG2A40G  
Cenere NATURALE PGG2A20G



60x60 cm Rect - 24"x24"

Gesso NATURALE PGW2A80  
Calce NATURALE PGW2A60  
Argilla NATURALE PGW2A50  
Terra NATURALE PGW2A90  
Cenere NATURALE PGW2A70  
Gesso EXT PGW2A30  
Calce EXT PGW2A10  
Argilla EXT PGW2A00  
Terra EXT PGW2A40  
Cenere EXT PGW2A20

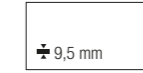

30x60 cm Rect - 12"x24"

Gesso NATURALE PG-2A80  
Calce NATURALE PG-2A60  
Argilla NATURALE PG-2A50  
Terra NATURALE PG-2A90  
Cenere NATURALE PG-2A70  
Gesso EXT PG-2A30  
Calce EXT PG-2A10  
Argilla EXT PG-2A00  
Terra EXT PG-2A40  
Cenere EXT PG-2A20

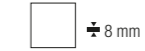

20x20 cm - 8"x8"

Gesso NATURALE PGE2A30  
Calce NATURALE PGE2A10  
Argilla NATURALE PGE2A00  
Terra NATURALE PGE2A40  
Cenere NATURALE PGE2A20

## GRES PORCELLANATO A MASSA COLORATA\_COLOURED-BODY PORCELAIN STONEWARE 20 mm

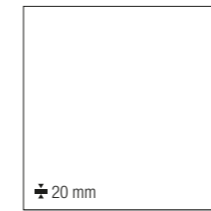

90x90 cm Rect - 36"x36"

Gesso STRUTTURATO PGG2A80  
Calce STRUTTURATO PGG2A60  
Argilla STRUTTURATO PGG2A50  
Terra STRUTTURATO PGG2A90  
Cenere STRUTTURATO PGG2A70

DESTINAZIONI D'USO\_INTENDED USE: NATURALE STRUTTURATO / EXT

### DATI TECNICI\_TECHNICAL DATA:

GRES PORCELLANATO A MASSA COLORATA COLOURED-BODY PORCELAIN STONEWARE	GRES PORCELLANATO A MASSA COLORATA COLOURED-BODY PORCELAIN STONEWARE
9,5 / 8 mm	20 mm
DIN 51130: R10 Naturale R11 Ext DIN 51097: A Naturale C (A+B+C) Ext BCR TORTUS: $\mu > 0,40$ Naturale - Ext ANSI A326.3: DCOF $\geq 0,42$ Naturale - Ext AS/NZS 4586: P4 Ext BS 7976-2: PTV 36+WET (SI.96 - SI.55) Ext	DIN 51130: R11 Strutturato DIN 51097: C (A+B+C) Strutturato BCR TORTUS: $\mu > 0,40$ Strutturato ANSI A326.3: DCOF $\geq 0,42$ Strutturato AS/NZS 4586: P4 Strutturato BS 7976-2: PTV 36+WET (SI.96 - SI.55) Strutturato
ANSI A137.1: V4 Naturale - Ext	ANSI A137.1: V4 Strutturato
<b>PROTECT</b> ANTIBATTERICO - ANTIMICROBIAL Naturale	/

### NATURALE:

Protezione antibatterica presente\_Integrated antibacterial protection\_Antibakterieller Schutz vorhanden\_Protection antibactérienne présente

# Opificio 22/a

## DECORI\_DECORS

GRES PORCELLANATO A MASSA COLORATA\_COLOURED-BODY PORCELAIN STONWARE

### GESSO



**MURETTO NATURALE**  
30x60 cm Rect - 12"x24"  
± 9,5 mm  
PGZ2AM3



**MOSAICO 16 PEZZI NATURALE**  
30x30 cm Rect - 12"x12"  
± 9,5 mm  
PGZ2A30

Abbinabile ai colori\_Matches with colors\_  
Mit den Farben kombinierbar\_À combiner avec les couleurs:  
**GESSO - CALCE - ARGILLA**



**TRAME CHIARO NATURALE**  
20x20 cm - 8"x8"  
± 8 mm  
PGE2A50



**QUADRI CHIARO NATURALE**  
20x20 cm - 8"x8"  
± 8 mm  
PGE2A80

**GRAFFITI:**  
Decoro sviluppato su 2 soggetti diversi venduti insieme\_Decoration developed on 2 different patterns sold together\_Dekor zu 2 verschiedenen Themen entwickelt, die zusammen verkauft werden\_Décor développé sur 2 sujets différents vendus ensemble  
Posare solo a parete\_Recommended only for wall applications\_Nur an der Wand verlegen\_Recommandé seulement pour les revêtements  
Protezione antibatterica non presente\_No antimicrobial protection\_Der Antibakterielle Schutz nicht vorhanden\_Protection antibactérienne pas présente

### CALCE



**MURETTO NATURALE**  
30x60 cm Rect - 12"x24"  
± 9,5 mm  
PGZ2AM1



**MOSAICO 16 PEZZI NATURALE**  
30x30 cm Rect - 12"x12"  
± 9,5 mm  
PGZ2A10

Abbinabile ai colori\_Matches with colors\_  
Mit den Farben kombinierbar\_À combiner avec les couleurs:  
**TERRA - CENERE**



**TRAME SCURO NATURALE**  
20x20 cm - 8"x8"  
± 8 mm  
PGE2A70



**QUADRI SCURO NATURALE**  
20x20 cm - 8"x8"  
± 8 mm  
PGE2A90

### TERRA



**MURETTO NATURALE**  
30x60 cm Rect - 12"x24"  
± 9,5 mm  
PGZ2AM4



**MOSAICO 16 PEZZI NATURALE**  
30x30 cm Rect - 12"x12"  
± 9,5 mm  
PGZ2A40

Abbinabile a tutti i colori\_Matches with all colors\_  
Kombinierbar mit allen Farben\_Combinable à tous les coloris



**TRAME MIX NATURALE**  
20x20 cm - 8"x8"  
± 8 mm  
PGE2A60



**GRAFFITI**  
30x60 cm Rect - 12"x24"  
± 9,5 mm  
PGZ2A50

### CENERE



**MURETTO NATURALE**  
30x60 cm Rect - 12"x24"  
± 9,5 mm  
PGZ2AM2



**MOSAICO 16 PEZZI NATURALE**  
30x30 cm Rect - 12"x12"  
± 9,5 mm  
PGZ2A20

# Opificio 22/a

## PEZZI SPECIALI\_TRIM PIECES

GRES PORCELLANATO A MASSA COLORATA\_COLOURED-BODY PORCELAIN STONWARE

<b>BATTISCOPA</b> 7,5x60 cm Rect - 3"x24" ± 10 mm NATURALE	<b>GRADONE A COSTA RETTA</b> 30x34 cm Rect - 12"x13 <sup>3/8</sup> "* ± 9,5 mm NATURALE	<b>ANGOLO GRADONE A COSTA RETTA</b> 34x34 cm - 13 <sup>3/8</sup> "x13 <sup>3/8</sup> "* ± 9,5 mm NATURALE	<b>BATTISCOPA SCALA DX (kit 2 pezzi)</b> 7,5x45 cm - 3"x18" ± 10 mm NATURALE	<b>BATTISCOPA SCALA SX (kit 2 pezzi)</b> 7,5x45 cm - 3"x18" ± 10 mm NATURALE	<b>ELEMENTO "L"</b> 15x30x4 cm Rect - 6"x12"x1 <sup>9/16</sup> "* ± 9,5 mm EXT*
GESSO PGR2A30	PGE2A30	PGE2A31	PGZ2A3D	PGZ2A3S	PGZ2AL3
CALCE PGR2A10	PGE2A10	PGE2A11	PGZ2A1D	PGZ2A1S	PGZ2AL1
ARGILLA PGR2A00	PGE2A00	PGE2A01	PGZ2A0D	PGZ2A0S	PGZ2AL0
TERRA PGR2A40	PGE2A40	PGE2A41	PGZ2A4D	PGZ2A4S	PGZ2AL4
CENERE PGR2A20	PGE2A20	PGE2A21	PGZ2A2D	PGZ2A2S	PGZ2AL2

**ELEMENTO "L":**  
Realizzato tramite incollaggio\_Made by gluing\_Hergestellt durch Kleben\_Réalisé par collage  
Abbinabile alla finitura Ext\_To be used with Ext version\_Kombinierbar mit Finish Ext\_Combinable à la finition Ext

GRES PORCELLANATO A MASSA COLORATA\_COLOURED-BODY PORCELAIN STONWARE **20 mm**

<b>COSTA TORO ANGOLORE DX</b> 30x90 cm Rect - 12"x36" STRUTTURATO*	<b>COSTA TORO ANGOLORE SX</b> 30x90 cm Rect - 12"x36" STRUTTURATO*	<b>COSTA TORO</b> 30x90 cm Rect - 12"x36" STRUTTURATO*	<b>COSTA TORO GRIP</b> 30x90 cm Rect - 12"x36" STRUTTURATO*	<b>COSTA RETTA ANGOLORE DX</b> 30x90 cm Rect - 12"x36" STRUTTURATO*	<b>COSTA RETTA ANGOLORE SX</b> 30x90 cm Rect - 12"x36" STRUTTURATO*
GESSO PGF2AK6	PGF2AK7	PGF2AF3	PGF2AJ3	PGF2AD6	PGF2AD7
CALCE PGF2AK2	PGF2AK3	PGF2AF1	PGF2AJ1	PGF2AD2	PGF2AD3
ARGILLA PGF2AK0	PGF2AK1	PGF2AF0	PGF2AJ0	PGF2AD0	PGF2AD1
TERRA PGF2AK8	PGF2AK9	PGF2AF4	PGF2AJ4	PGF2AD8	PGF2AD9
CENERE PGF2AK4	PGF2AK5	PGF2AF2	PGF2AJ2	PGF2AD4	PGF2AD5
<b>COSTA RETTA</b> 30x90 cm Rect - 12"x36" STRUTTURATO*	<b>COSTA RETTA GRIP</b> 30x90 cm Rect - 12"x36" STRUTTURATO*	<b>GRIGLIA ANGOLORE DX</b> 15x45 cm Rect - 6"x18" STRUTTURATO*	<b>GRIGLIA ANGOLORE SX</b> 15x45 cm Rect - 6"x18" STRUTTURATO*	<b>GRIGLIA</b> 15x45 cm Rect - 6"x18" STRUTTURATO*	
GESSO PGF2AC3	PGF2AG3	PGD2AA6	PGD2AA7	PGD2AZ8	
CALCE PGF2AC1	PGF2AG1	PGD2AA2	PGD2AA3	PGD2AZ6	
ARGILLA PGF2AC0	PGF2AG0	PGD2AA0	PGD2AA1	PGD2AZ5	
TERRA PGF2AC4	PGF2AG4	PGD2AA8	PGD2AA9	PGD2AZ9	
CENERE PGF2AC2	PGF2AG2	PGD2AA4	PGD2AA5	PGD2AZ7	

\* Protezione antibatterica non presente\_No antimicrobial protection\_Der Antibakterielle Schutz nicht vorhanden\_Protection antibactérienne pas présente

## IMBALLAGGI E PESI\_PACKINGS AND WEIGHTS

DESCRIZIONE Description	± mm	FORMATI Sizes	SCATOLA_Box				PALLET		
FONDO NATURALE	9,5	90x90 <sup>RECT</sup>	2	33,6	1,62	-	25	840	40,5
FONDO NATURALE / EXT	9,5	60x60 <sup>RECT</sup>	4	31,8	1,44	-	32	1017,6	46,08
FONDO NATURALE / EXT	9,5	30x60 <sup>RECT</sup>	8	31,8	1,44	-	32	1017,6	46,08
FONDO NATURALE	8	20x20	34	22,6	1,36	-	45	1017	61,2
FONDO STRUTTURATO	20	90x90 <sup>RECT</sup>	1	37,3	0,81	-	30	1119	24,3
GRAFFITI	9,5	30x60 <sup>RECT</sup>	2	7,5	0,36	-	48	360	17,28
MURETTO NATURALE	9,5	30x60 <sup>RECT</sup>	4	15	0,72	-	30	450	21,6
MOSAICO 16 PEZZI NATURALE	9,5	30x30 <sup>RECT</sup>	4	7,2	0,36	-	78	561,6	28
TRAME CHIARO NATURALE	8	20x20	34	22,6	1,36	-	45	1017	61,2
TRAME SCURO NATURALE	8	20x20	34	22,6	1,36	-	45	1017	61,2
TRAME MIX NATURALE	8	20x20	34	22,6	1,36	-	45	1017	61,2
QUADRI CHIARO NATURALE	8	20x20	34	22,6	1,36	-	45	1017	61,2
QUADRI SCURO NATURALE	8	20x20	34	22,6	1,36	-	45	1017	61,2
BATTISCOPA NATURALE	10	7,5x60 <sup>RECT</sup>	12	11,61	0,54	7,2	60	696,6	32,4
BATTISCOPA SCALA (KIT 2 PZ.) NATURALE	10	7,5x45	5	7,5	0,337	-	-	-	-
GRADONE A COSTA RETTA NATURALE	9,5	30x34 <sup>RECT</sup>	6	19,95	0,612	-	30	598,5	18,36
ANGOLO GRADONE A COSTA RETTA NATURALE	9,5	34x34	2	6,27	0,231	-	48	300,96	11,097
ELEMENTO "L" EXT	9,5	15x30x4 <sup>RECT</sup>	8	8,74	0,36	2,4	48	419,52	17,28
COSTA TORO STRUTTURATO	20	30x90 <sup>RECT</sup>	1	12,2	0,27	-	32	390,4	8,64
COSTA TORO ANGOLORE STRUTTURATO	20	30x90 <sup>RECT</sup>	1	10,2	0,225	-	32	326,4	7,2
COSTA TORO GRIP STRUTTURATO	20	30x90 <sup>RECT</sup>	1	12,2	0,27	-	32	390,4	8,64
COSTA RETTA STRUTTURATO	20	30x90 <sup>RECT</sup>	1	12,2	0,27	-	32	390,4	8,64
COSTA RETTA ANGOLORE STRUTTURATO	20	30x90 <sup>RECT</sup>	1	10,2	0,225	-	32	326,4	7,2
COSTA RETTA GRIP STRUTTURATO	20	30x90 <sup>RECT</sup>	1	12,2	0,27	-	32	390,4	8,64
GRIGLIA STRUTTURATO	20	15x45 <sup>RECT</sup>	4	11,2	0,27	-	48	537,6	12,96
GRIGLIA ANGOLORE STRUTTURATO	20	15x45 <sup>RECT</sup>	4	10	0,225	-	48	480	10,8

# Urbanature



LIME



CONCRETE



CEMENT



PORTLAND



SILICON

GRES PORCELLANATO LAMINATO\_LAMINATED PORCELAIN STONEWARE **Zero.3**



± 3,5 mm

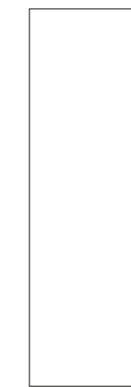

100x300 cm Rect  
39"x118"



100x100 cm Rect  
39"x39"



50x100 cm Rect  
19 1/2"x39"

GRES PORCELLANATO A MASSA COLORATA\_COLOURED-BODY PORCELAIN STONEWARE



± 9,5 mm



90x90 cm Rect  
36"x36"



45x90 cm Rect  
18"x36"



22,5x90 cm Rect  
9"x36"



60x60 cm Rect  
24"x24"



30x60 cm Rect  
12"x24"

GRES PORCELLANATO A MASSA COLORATA\_COLOURED-BODY PORCELAIN STONEWARE **20 mm**



± 20 mm



60x60 cm Rect  
24"x24"  
60,3x60,3 cm  
24"x24"



RIVESTIMENTO / WALL Lime Naturale 100x300 cm Rect - 39"x118" \_100x100 cm Rect - 39"x39" \_50x100 cm Rect - 19 1/2"x39"  
 PAVIMENTO / FLOOR Silicon Naturale 100x100 cm Rect - 39"x39"



RIVESTIMENTO / WALL Lime Naturale 100x300 cm Rect - 39"x118" \_50x100 cm Rect - 19 1/2"x39"  
 PAVIMENTO / FLOOR Silicon Naturale 100x100 cm Rect - 39"x39"



RIVESTIMENTO / WALL Portland Naturale 100x300 cm Rect - 39"x118" \_50x100 cm Rect - 19 1/2"x39" \_Urban Stripes Portland 50x100 cm Rect - 19 1/2"x39"  
PAVIMENTO / FLOOR Portland Naturale 100x100 cm Rect - 39"x39"



RIVESTIMENTO / WALL Urban Steel Portland Naturale 60x60 cm Rect - 24"x24"  
PAVIMENTO / FLOOR Portland Naturale 60x60 cm Rect - 24"x24"



RIVESTIMENTO / WALL Portland Naturale 30x60 cm Rect - 12"x24" \_Urban Texture Portland 30x60 cm Rect - 12"x24"



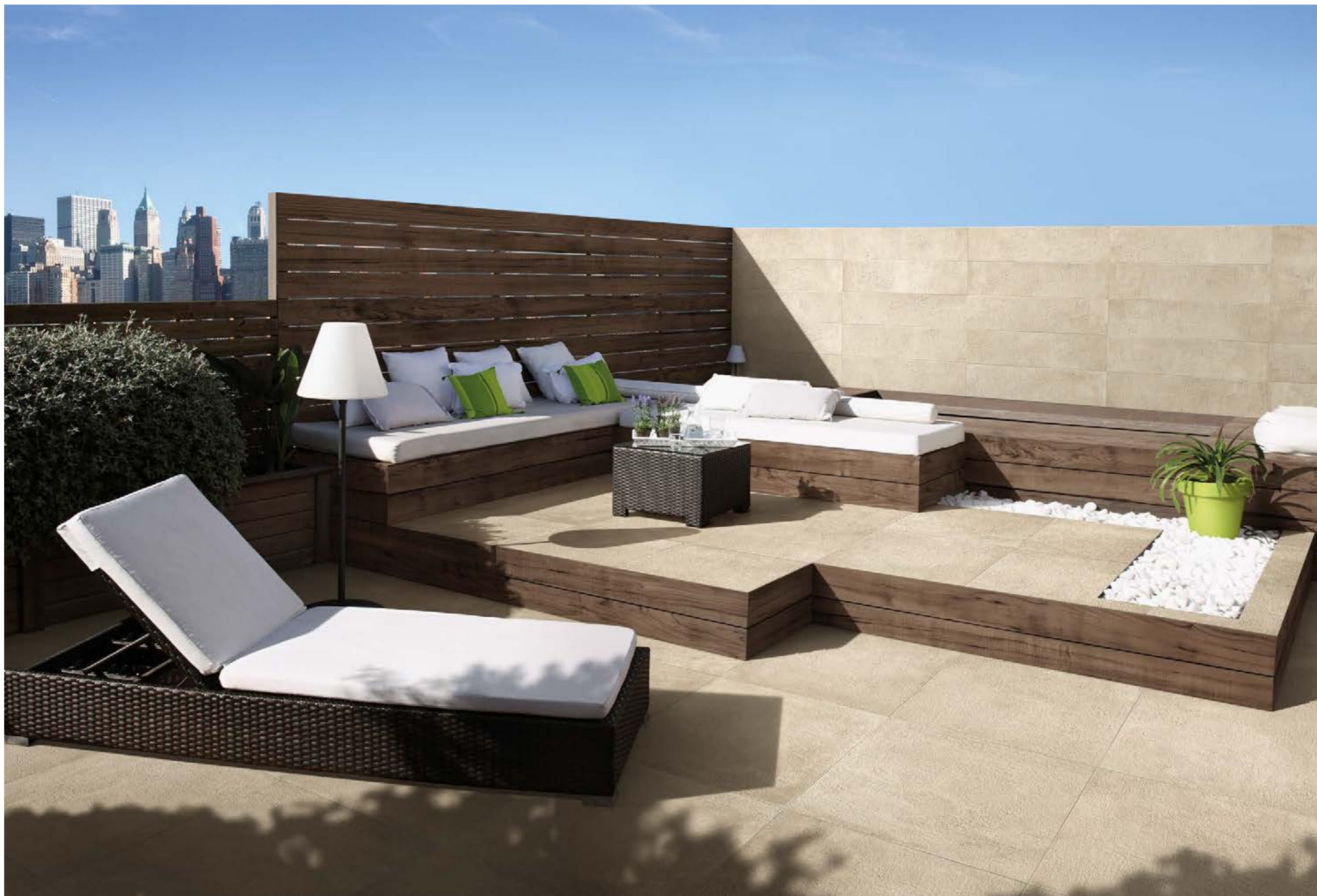

RIVESTIMENTO / WALL Concrete Naturale 22,5x90 cm Rect - 9"x36"  
 PAVIMENTO / FLOOR Concrete Strutturato 60,3x60,3 cm - 24"x24" 20 mm

## LIME



## CONCRETE



## CEMENT



## PORTLAND



## SILICON



DESTINAZIONI D'USO\_INTENDED USE: NATURALE STRUTTURATO / EXT

### DATI TECNICI\_TECHNICAL DATA:

GRES PORCELLANATO LAMINATO LAMINATED PORCELAIN STONEWARE	GRES PORCELLANATO A MASSA COLORATA COLOURED-BODY PORCELAIN STONEWARE	GRES PORCELLANATO A MASSA COLORATA COLOURED-BODY PORCELAIN STONEWARE
3,5 mm	9,5 mm	20 mm
DIN 51130: <b>R9</b> Naturale <b>R11</b> Ext DIN 51097: <b>C (A+B+C)</b> Ext BCR TORTUS: $\mu > 0,40$ Naturale - Ext ANSI A326.3: <b>DCOF <math>\geq 0,42</math></b> Naturale - Ext AS/NZS 4586: <b>P4</b> Ext BS 7976-2: <b>PTV 36+WET (SI.96 - SI.55)</b> Ext	DIN 51130: <b>R9</b> Naturale <b>R11</b> Ext DIN 51097: <b>C (A+B+C)</b> Strutturato BCR TORTUS: $\mu > 0,40$ Strutturato ANSI A326.3: <b>DCOF <math>\geq 0,42</math></b> Strutturato AS/NZS 4586: <b>P4</b> Strutturato BS 7976-2: <b>PTV 36+WET (SI.96 - SI.55)</b> Strutturato	DIN 51130: <b>R11</b> Strutturato DIN 51097: <b>C (A+B+C)</b> Strutturato BCR TORTUS: $\mu > 0,40$ Strutturato ANSI A326.3: <b>DCOF <math>\geq 0,42</math></b> Strutturato AS/NZS 4586: <b>P4</b> Strutturato BS 7976-2: <b>PTV 36+WET (SI.96 - SI.55)</b> Strutturato
ANSI A137.1: <b>V2</b> Naturale	ANSI A137.1: <b>V2</b> Naturale - Ext	ANSI A137.1: <b>V2</b> Strutturato

## GRES PORCELLANATO LAMINATO\_LAMINATED PORCELAIN STONEWARE **Zero.3**



100x300 cm Rect - 39"x118"

Lime NATURALE\* PZ7UN00  
Concrete NATURALE\* PZ7UN10  
Cement NATURALE\* PZ7UN20  
Portland NATURALE\* PZ7UN30  
Silicon NATURALE\* PZ7UN40



100x100 cm Rect - 39"x39"

Lime NATURALE\* PZ8UN00  
Concrete NATURALE\* PZ8UN10  
Cement NATURALE\* PZ8UN20  
Portland NATURALE\* PZ8UN30  
Silicon NATURALE\* PZ8UN40

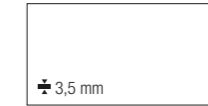

50x100 cm Rect - 19<sup>1/2</sup>"x39"

Lime NATURALE\* PZ9UN00  
Concrete NATURALE\* PZ9UN10  
Cement NATURALE\* PZ9UN20  
Portland NATURALE\* PZ9UN30  
Silicon NATURALE\* PZ9UN40

## GRES PORCELLANATO A MASSA COLORATA\_COLOURED-BODY PORCELAIN STONEWARE



90x90 cm Rect - 36"x36"

Lime NATURALE PGGUNR0G  
Concrete NATURALE PGGUNR1G  
Cement NATURALE PGGUNR2G  
Portland NATURALE PGGUNR3G  
Silicon NATURALE PGGUNR4G  
Portland EXT\* PGGUNG3G

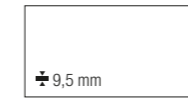

45x90 cm Rect - 18"x36"

Lime NATURALE PGHUN00G  
Concrete NATURALE PGHUN10G  
Cement NATURALE PGHUN20G  
Portland NATURALE PGHUN30G  
Silicon NATURALE PGHUN40G

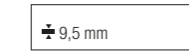

22,5x90 cm Rect - 9"x36"

Lime NATURALE PG2UN00G  
Concrete NATURALE PG2UN10G  
Cement NATURALE PG2UN20G  
Portland NATURALE PG2UN30G  
Silicon NATURALE PG2UN40G

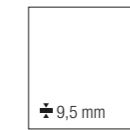

60x60 cm Rect - 24"x24"

Lime NATURALE PGWUN01P  
Concrete NATURALE PGWUN11P  
Cement NATURALE PGWUN21P  
Portland NATURALE PGWUN31P  
Silicon NATURALE PGWUN41P  
  
60,3x60,3 cm - 24"x24"  
Lime NATURALE PGWUN00P  
Concrete NATURALE PGWUN10P  
Cement NATURALE PGWUN20P  
Portland NATURALE PGWUN30P  
Silicon NATURALE PGWUN40P

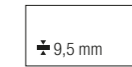

30x60 cm Rect - 12"x24"

Lime NATURALE PG-UN01  
Concrete NATURALE PG-UN11  
Cement NATURALE PG-UN21  
Portland NATURALE PG-UN31  
Silicon NATURALE PG-UN41

## GRES PORCELLANATO A MASSA COLORATA\_COLOURED-BODY PORCELAIN STONEWARE **20 mm**



60x60 cm Rect - 24"x24"

Cement STRUTTURATO\* PGWUN29  
Portland STRUTTURATO\* PGWUN39

60,3x60,3 cm - 24"x24"









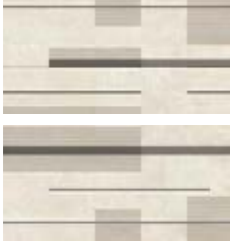

Cement STRUTTURATO\* PGWUN28  
Portland STRUTTURATO\* PGWUN38

\* Protezione antibatterica non presente\_No antimicrobial protection\_Der Antibakterielle Schutz nicht vorhanden\_Protection antibactérienne pas présente

# Urbanature

DECORI\_DECORS

GRES PORCELLANATO LAMINATO\_LAMINATED PORCELAIN STONEWARE **Zero.3**

LIME	CONCRETE	CEMENT	PORTLAND	SILICON
				
<b>URBAN STRIPES*</b> 50x100 cm Rect - 19 <sup>1</sup> / <sub>2</sub> "x39" ± 3 mm PZ9UNS0	<b>URBAN STRIPES*</b> 50x100 cm Rect - 19 <sup>1</sup> / <sub>2</sub> "x39" ± 3 mm PZ9UNS1	<b>URBAN STRIPES*</b> 50x100 cm Rect - 19 <sup>1</sup> / <sub>2</sub> "x39" ± 3 mm PZ9UNS2	<b>URBAN STRIPES*</b> 50x100 cm Rect - 19 <sup>1</sup> / <sub>2</sub> "x39" ± 3 mm PZ9UNS3	<b>URBAN STRIPES*</b> 50x100 cm Rect - 19 <sup>1</sup> / <sub>2</sub> "x39" ± 3 mm PZ9UNS4
				
				
<b>URBAN LEAVES 1*</b> 50x100 cm Rect - 19 <sup>1</sup> / <sub>2</sub> "x39" ± 3 mm PZ9UNL1	<b>URBAN LEAVES 2*</b> 50x100 cm Rect - 19 <sup>1</sup> / <sub>2</sub> "x39" ± 3 mm PZ9UNL2			
				
<b>URBAN TWEED 1</b> 50x100 cm Rect - 19 <sup>1</sup> / <sub>2</sub> "x39" ± 3 mm PZ9UNT1	<b>URBAN TWEED 2</b> 50x100 cm Rect - 19 <sup>1</sup> / <sub>2</sub> "x39" ± 3 mm PZ9UNT2			

URBAN STRIPES, URBAN LEAVES 1, URBAN LEAVES 2, URBAN TWEED 1, URBAN TWEED 2:

Posare solo a parete\_Recommended only for wall applications\_Nur an der Wand verlegen\_Recommandé seulement pour les revêtements















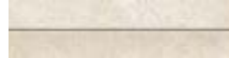

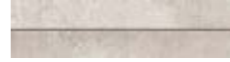



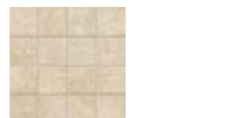
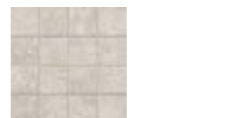

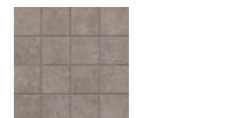
Protezione antibatterica non presente\_No antimicrobial protection\_Der Antibakterielle Schutz nicht vorhanden\_Protection antibactérienne pas présente

\* Sviluppato su 2 soggetti, venduto solo a scatole complete\_Developed on 2 patterns, full boxes order only\_Paarweise, nur als komplette Verpackung erhältlich\_Développé sur 2 éléments, vendu uniquement en boîtes complètes

# Urbanature

DECORI\_DECORS

GRES PORCELLANATO A MASSA COLORATA\_COLOURED-BODY PORCELAIN STONEWARE

LIME	CONCRETE	CEMENT	PORTLAND	SILICON
				
<b>URBAN STEEL NATURALE</b> 60x60 cm Rect - 24"x24" ± 9,5 mm PGWUNS0	<b>URBAN STEEL NATURALE</b> 60x60 cm Rect - 24"x24" ± 9,5 mm PGWUNS1	<b>URBAN STEEL NATURALE</b> 60x60 cm Rect - 24"x24" ± 9,5 mm PGWUNS2	<b>URBAN STEEL NATURALE</b> 60x60 cm Rect - 24"x24" ± 9,5 mm PGWUNS3	<b>URBAN STEEL NATURALE</b> 60x60 cm Rect - 24"x24" ± 9,5 mm PGWUNS4
				
<b>URBAN WAVY NATURALE</b> 15x60 cm Rect - 6"x24" ± 9,5 mm PG1UN00	<b>URBAN WAVY NATURALE</b> 15x60 cm Rect - 6"x24" ± 9,5 mm PG1UN10	<b>URBAN WAVY NATURALE</b> 15x60 cm Rect - 6"x24" ± 9,5 mm PG1UN20	<b>URBAN WAVY NATURALE</b> 15x60 cm Rect - 6"x24" ± 9,5 mm PG1UN30	<b>URBAN WAVY NATURALE</b> 15x60 cm Rect - 6"x24" ± 9,5 mm PG1UN40
				
<b>MOSAICO 16 PEZZI NATURALE</b> 30x30 cm Rect - 12"x12" ± 9,5 mm PGZUN00	<b>MOSAICO 16 PEZZI NATURALE</b> 30x30 cm Rect - 12"x12" ± 9,5 mm PGZUN10	<b>MOSAICO 16 PEZZI NATURALE</b> 30x30 cm Rect - 12"x12" ± 9,5 mm PGZUN20	<b>MOSAICO 16 PEZZI NATURALE</b> 30x30 cm Rect - 12"x12" ± 9,5 mm PGZUN30	<b>MOSAICO 16 PEZZI NATURALE</b> 30x30 cm Rect - 12"x12" ± 9,5 mm PGZUN40
				
<b>URBAN WOOD*</b> 45x90 cm Rect - 18"x36" ± 9,5 mm PGHUN04	<b>URBAN WOOD*</b> 45x90 cm Rect - 18"x36" ± 9,5 mm PGHUN24	<b>URBAN WOOD*</b> 45x90 cm Rect - 18"x36" ± 9,5 mm PGHUN34	<b>URBAN WOOD*</b> 45x90 cm Rect - 18"x36" ± 9,5 mm PGHUN44	<b>URBAN WOOD LISTONE*</b> 22,5x90 cm Rect - 9"x36" ± 9,5 mm PG2UN54
				
<b>URBAN TEXTURE*</b> 30x60 cm Rect - 12"x24" ± 9,5 mm PG-UN13	<b>LISTELLO URBAN TEXTURE*</b> 6x60 cm Rect - 2 <sup>3</sup> / <sub>8</sub> "x24" ± 9,5 mm PGTUN13	<b>URBAN TEXTURE*</b> 30x60 cm Rect - 12"x24" ± 9,5 mm PG-UN33	<b>LISTELLO URBAN TEXTURE*</b> 6x60 cm Rect - 2 <sup>3</sup> / <sub>8</sub> "x24" ± 9,5 mm PGTUN33	

URBAN WOOD, URBAN WOOD LISTONE, URBAN TEXTURE, LISTELLO URBAN TEXTURE, URBAN WAVY, URBAN STEEL:



Posare solo a parete\_Recommended only for wall applications\_Nur an der Wand verlegen\_Recommandé seulement pour les revêtements



Protezione antibatterica non presente\_No antimicrobial protection\_Der Antibakterielle Schutz nicht vorhanden\_Protection antibactérienne pas présente

# Urbanature

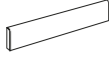
## PEZZI SPECIALI\_TRIM PIECES

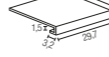
### GRES PORCELLANATO A MASSA COLORATA\_COLOURED-BODY PORCELAIN STONWARE

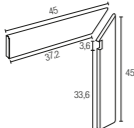
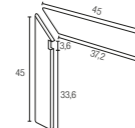
			
<b>BATTISCOPA</b> 10x60,3 cm Rect - 4''x24'' ± 10 mm NATURALE	<b>BATTISCOPA</b> 10x60,3 cm - 4''x24'' ± 10 mm NATURALE	<b>ANGOLO GRADONE A COSTA RETTA</b> 34x34 cm - 13''x13'' ± 9,5 mm NATURALE	<b>GRADONE A COSTA RETTA</b> 30x34 cm Rect - 12''x13'' ± 9,5 mm NATURALE
LIME	PGRUNR0	PGRUN00	PGEUN01
CONCRETE	PGRUNR1	PGRUN10	PGEUN11
CEMENT	PGRUNR2	PGRUN20	PGEUN21
PORTLAND	PGRUNR3	PGRUN30	PGEUN31
SILICON	PGRUNR4	PGRUN40	PGEUN41





			
<b>BATTISCOPA SCALA DX</b> (kit 2 pezzi) 10x45 cm - 4''x18'' ± 10 mm NATURALE	<b>BATTISCOPA SCALA SX</b> (kit 2 pezzi) 10x45 cm - 4''x18'' ± 10 mm NATURALE	<b>RACCORDO</b> 1x30 cm Rect - 3/8''x12'' NATURALE	<b>ANGOLO RACCORDO</b> 1x1 cm - 3/8''x3/8'' NATURALE
LIME	PGZUN0D	PGZUN0S	PGZUNR0
CONCRETE	PGZUN1D	PGZUN1S	PGZUNR1
CEMENT	PGZUN2D	PGZUN2S	PGZUNR2
PORTLAND	PGZUN3D	PGZUN3S	PGZUNR3
SILICON	PGZUN4D	PGZUN4S	PGZUNR4

### RACCORDO, ANGOLO RACCORDO:

Posare solo all'interno\_Strictly for interiors\_Nur im Innenraum zu verlegen\_Poser seulement à l'intérieur

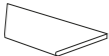
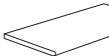
Protezione antibatterica non presente\_No antimicrobial protection\_Der Antibakterielle Schutz nicht vorhanden\_Protection antibactérienne pas présente

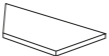
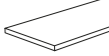

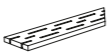
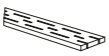
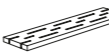



### GRES PORCELLANATO A MASSA COLORATA\_COLOURED-BODY PORCELAIN STONWARE 20 mm

					
<b>COSTA TORO ANGOLARE DX</b> 30x60 cm Rect - 12''x24'' STRUTTURATO*	<b>COSTA TORO ANGOLARE SX</b> 30x60 cm Rect - 12''x24'' STRUTTURATO*	<b>COSTA TORO</b> 30x60 cm Rect - 12''x24'' STRUTTURATO*	<b>COSTA TORO GRIP</b> 30x60 cm Rect - 12''x24'' STRUTTURATO*	<b>COSTA RETTA ANGOLARE DX</b> 30x60 cm Rect - 12''x24'' STRUTTURATO*	<b>COSTA RETTA ANGOLARE SX</b> 30x60 cm Rect - 12''x24'' STRUTTURATO*
CEMENT	PGDUNK4	PGDUNK2	PGDUNF2	PGDUNJ2	PGDUND4
PORTLAND	PGDUNK5	PGDUNK3	PGDUNF3	PGDUNJ3	PGDUND5
					
<b>COSTA RETTA</b> 30x60 cm Rect - 12''x24'' STRUTTURATO*	<b>COSTA RETTA GRIP</b> 30x60 cm Rect - 12''x24'' STRUTTURATO*	<b>GRIGLIA ANGOLARE DX</b> 15x60 cm Rect - 6''x24'' STRUTTURATO*	<b>GRIGLIA ANGOLARE SX</b> 15x60 cm Rect - 6''x24'' STRUTTURATO*	<b>GRIGLIA</b> 15x60 cm Rect - 6''x24'' STRUTTURATO*	
CEMENT	PGDUNC2	PGDUNA2	PGDUNA4	PGDUNA2	PGDUNZ2
PORTLAND	PGDUNC3	PGDUNA3	PGDUNA5	PGDUNA3	PGDUNZ3

\* Protezione antibatterica non presente\_No antimicrobial protection\_Der Antibakterielle Schutz nicht vorhanden\_Protection antibactérienne pas présente

# Urbanature

## IMBALLAGGI E PESI\_PACKINGS AND WEIGHTS

DESCRIZIONE Description	± mm	FORMATI Sizes	SCATOLA_Box				PALLET		
									
FONDO NATURALE	3,5	100x300 <sup>RECT</sup>	1	23,4	3	-	20	468	60
FONDO NATURALE	3,5	100x100 <sup>RECT</sup>	3	23,4	3	-	25	585	75
FONDO NATURALE	3,5	50x100 <sup>RECT</sup>	5	19,5	2,5	-	32	624	80
FONDO NATURALE / EXT	9,5	90x90 <sup>RECT</sup>	2	33,6	1,62	-	25	840	40,5
FONDO NATURALE	9,5	45x90 <sup>RECT</sup>	3	25,2	1,215	-	36	907,2	43,74
FONDO NATURALE	9,5	22,5x90 <sup>RECT</sup>	4	17,27	0,81	-	44	760	35,6
FONDO NATURALE	9,5	60x60 <sup>RECT</sup>	4	31,8	1,44	-	32	1018	46,1
FONDO NATURALE	9,5	60,3x60,3	4	31,8	1,45	-	32	1018	46,5
FONDO NATURALE	9,5	30x60 <sup>RECT</sup>	8	31,8	1,44	-	32	1018	46,1
URBAN STRIPES	3	50x100 <sup>RECT</sup>	2	7	1	-	25	175	25
URBAN LEAVES 1/2	3	50x100 <sup>RECT</sup>	2	7	1	-	25	175	25
URBAN TWEED 1/2	3	50x100 <sup>RECT</sup>	2	7	1	-	25	175	25
URBAN STEEL NATURALE	9,5	60x60 <sup>RECT</sup>	2	15,9	0,72	-	20	318	14,4
URBAN WAVY NATURALE	9,5	15x60 <sup>RECT</sup>	4	7,9	0,36	-	48	379	17,3
MOSAICO 16 PEZZI NATURALE	9,5	30x30 <sup>RECT</sup>	4	7,2	0,36	-	78	562	28,1
URBAN WOOD	9,5	45x90 <sup>RECT</sup>	2	17,3	0,81	-	15	259	12,2
URBAN WOOD LISTONE	9,5	22,5x90 <sup>RECT</sup>	2	8,6	0,4	-	45	389	18,2
URBAN TEXTURE	9,5	30x60 <sup>RECT</sup>	2	8	0,36	-	128	1024	46,1
LISTELLO URBAN TEXTURE	9,5	6x60 <sup>RECT</sup>	4	3	0,14	-	-	-	-
RACCORDO NATURALE	-	1x30 <sup>RECT</sup>	8	0,8	0,02	-	-	-	-
ANGOLO RACCORDO NATURALE	-	1x1	10	0,07	0,001	-	-	-	-
BATTISCOPA NATURALE	10	10x60 <sup>RECT</sup>	12	15,48	0,72	7,2	60	929	43,2
BATTISCOPA NATURALE	10	10x60,3	16	20	0,9648	9,648	48	960	46,31
BATTISCOPA SCALA NATURALE	10	10x45	5	8,5	0,43	-	-	-	-
GRADONE A COSTA RETTA NATURALE	9,5	30x34 <sup>RECT</sup>	6	17,1	0,61	-	30	513	18,4
ANGOLO GRADONE A COSTA RETTA NATURALE	9,5	34x34	2	6,3	0,23	-	48	301	11,1
FONDO STRUTTURATO	20	60x60 <sup>RECT</sup>	2	33	0,72	-	32	1056	23,04
FONDO STRUTTURATO	20	60,3x60,3	2	33,3	0,72	-	32	1065,6	23,04
COSTA TORO STRUTTURATO	20	30x60 <sup>RECT</sup>	1	8,13	0,135	-	100	813	13,5
COSTA TORO ANGOLARE STRUTTURATO	20	30x60 <sup>RECT</sup>	1	6,1	0,135	-	100	610	13,5
COSTA TORO GRIP STRUTTURATO	20	30x60 <sup>RECT</sup>	1	8,13	0,135	-	100	813	13,5
COSTA RETTA STRUTTURATO	20	30x60 <sup>RECT</sup>	1	8,13	0,135	-	100	813	13,5
COSTA RETTA ANGOLARE STRUTTURATO	20	30x60 <sup>RECT</sup>	1	6,1	0,135	-	100	610	13,5
COSTA RETTA GRIP STRUTTURATO	20	30x60 <sup>RECT</sup>	1	8,13	0,135	-	100	813	13,5
GRIGLIA STRUTTURATO	20	15x60 <sup>RECT</sup>	2	8	0,158	-	100	800	15,75
GRIGLIA ANGOLARE STRUTTURATO	20	15x60 <sup>RECT</sup>	2	7	0,158	-	100	700	15,75



## Effetto marmo

Marble look\_Marmor-Optik\_Effet marbre



RIVESTIMENTO / WALL Marquina Black Lux 120x260 cm Rect - 48"x102"  
 PAVIMENTO / FLOOR Statuario White Lux 120x120 cm Rect - 48"x48"

# Eternity



STATUARIO WHITE



ARABESQUE PEARL



BREACH GREY



MARQUINA BLACK

GRES PORCELLANATO LAMINATO\_LAMINATED PORCELAIN STONEWARE **Zero.3**



± 6 mm



120x260 cm Rect  
48"x102"

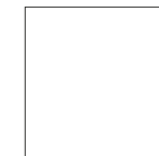

120x120 cm Rect  
48"x48"

GRES PORCELLANATO A MASSA COLORATA\_COLOURED-BODY PORCELAIN STONEWARE



± 9,5 mm



60x120 cm Rect  
24"x48"



60x60 cm Rect  
24"x24"



30x60 cm Rect  
12"x24"



RIVESTIMENTO / WALL Arabesque Pearl Lux 120x260 cm Rect - 48"x102"  
PAVIMENTO / FLOOR Marquina Black Soft 120x120 cm Rect - 48"x48"



PAVIMENTO / FLOOR Breach Grey Soft 60x120 cm Rect - 24"x48"



PAVIMENTO / FLOOR Statuario White Lux 60x60 cm Rect - 24"x24"  
Listello Marquina Black Lux 7x60 cm - 2<sup>3</sup>/<sub>4</sub>"x24" \_Quadrato Marquina Black Lux 7x7 cm - 2<sup>3</sup>/<sub>4</sub>"x2<sup>3</sup>/<sub>4</sub>"





RIVESTIMENTO / WALL Mosaico Kubic Arabesque Pearl Lux 17x29,2 cm Rect - 6<sup>5/8</sup>"x11<sup>1/2</sup>"\_Arabesque Pearl Lux 30x60 cm Rect - 12"x24"  
 Marquina Black Lux 60x120 cm Rect - 24"x48"

PAVIMENTO / FLOOR Arabesque Pearl Soft 60x60 cm Rect - 24"x24"\_Marquina Black Soft 60x120 cm Rect - 24"x48"



RIVESTIMENTO / WALL Statuario White Lux 120x260 cm Rect - 48"x102"\_Bookmatch Statuario White Lux 120x260 cm Rect - 48"x102"  
PAVIMENTO / FLOOR Statuario White Soft 120x260 cm Rect - 48"x102"



RIVESTIMENTO / WALL Marquina Black Lux 120x260 cm Rect - 48"x102"\_Bookmatch Arabesque Pearl Lux 120x260 cm Rect - 48"x102"  
PAVIMENTO / FLOOR Arabesque Pearl Lux 120x120 cm Rect - 48"x48"



PAVIMENTO / FLOOR Chevron Statuario White Soft 9,5x54 cm Rect - 3<sup>3</sup>/<sub>4</sub>"x21<sup>1</sup>/<sub>4</sub>"

# Eternity

**PR( )TECT**  
ANTIBATTERICO - ANTIMICROBIAL

STATUARIO WHITE



ARABESQUE PEARL



BREACH GREY



MARQUINA BLACK

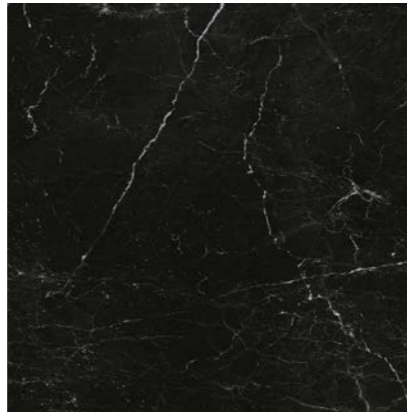

# Eternity

GRES PORCELLANATO LAMINATO\_LAMINATED PORCELAIN STONEWARE **Zero.3**



120x260 cm Rect - 48"x102"

Statuario White SOFT PZ6EN201  
Arabesque Pearl SOFT PZ6EN001  
Breach Grey SOFT PZ6EN101  
Marquina Black SOFT PZ6EN301  
Statuario White LUX PZ6EN251  
Arabesque Pearl LUX PZ6EN051  
Breach Grey LUX PZ6EN151  
Marquina Black LUX PZ6EN351

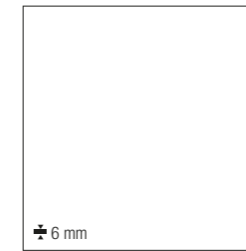

120x120 cm Rect - 48"x48"

Statuario White SOFT PZ8EN20  
Arabesque Pearl SOFT PZ8EN00  
Breach Grey SOFT PZ8EN10  
Marquina Black SOFT PZ8EN30  
Statuario White LUX PZ8EN25  
Arabesque Pearl LUX PZ8EN05  
Breach Grey LUX PZ8EN15  
Marquina Black LUX PZ8EN35

GRES PORCELLANATO A MASSA COLORATA\_COLOURED-BODY PORCELAIN STONEWARE

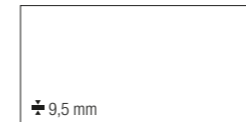

60x120 cm Rect - 24"x48"

Statuario White SOFT PGXEN20  
Arabesque Pearl SOFT PGXEN00  
Breach Grey SOFT PGXEN10  
Marquina Black SOFT PGXEN30  
Statuario White LUX PGXEN25  
Arabesque Pearl LUX PGXEN05  
Breach Grey LUX PGXEN15  
Marquina Black LUX PGXEN35

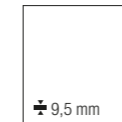

60x60 cm Rect - 24"x24"

Statuario White SOFT PGWEN20  
Arabesque Pearl SOFT PGWEN00  
Breach Grey SOFT PGWEN10  
Marquina Black SOFT PGWEN30  
Statuario White LUX PGWEN25  
Arabesque Pearl LUX PGWEN05  
Breach Grey LUX PGWEN15  
Marquina Black LUX PGWEN35





30x60 cm Rect - 12"x24"

Statuario White SOFT PGVEN20  
Arabesque Pearl SOFT PGVEN00  
Breach Grey SOFT PGVEN10  
Marquina Black SOFT PGVEN30  
Statuario White LUX PGVEN25  
Arabesque Pearl LUX PGVEN05  
Breach Grey LUX PGVEN15  
Marquina Black LUX PGVEN35

DESTINAZIONI D'USO\_INTENDED USE: SOFT / LUX  

DATI TECNICI\_TECHNICAL DATA:

GRES PORCELLANATO LAMINATO LAMINATED PORCELAIN STONEWARE	GRES PORCELLANATO A MASSA COLORATA COLOURED-BODY PORCELAIN STONEWARE
6 mm	9,5 mm
 ANSI A326.3: DCOF ≥ 0.42 Soft	ANSI A326.3: DCOF ≥ 0.42 Soft
 ANSI A137.3: V2 Soft - Lux	ANSI A137.1: V2 Soft - Lux
<b>PR( )TECT</b> ANTIBATTERICO - ANTIMICROBIAL Soft - Lux	<b>PR( )TECT</b> ANTIBATTERICO - ANTIMICROBIAL Soft - Lux

# Eternity

DECORI\_DECORS

GRES PORCELLANATO LAMINATO\_LAMINATED PORCELAIN STONEWARE **Zero.3**

## STATUARIO WHITE BOOKMATCH LUX A+B



LUX A  
120x260 cm Rect - 48"x102"  
± 6 mm  
PZ6ENA21

LUX B  
120x260 cm Rect - 48"x102"  
± 6 mm  
PZ6ENB21

## ARABESQUE PEARL BOOKMATCH LUX A+B



LUX A  
120x260 cm Rect - 48"x102"  
± 6 mm  
PZ6ENA01

LUX B  
120x260 cm Rect - 48"x102"  
± 6 mm  
PZ6ENB01

L'immagine è puramente indicativa. La grafica di bookmatch può presentare discontinuità di vena nel passaggio tra le lastre, al pari del materiale naturale. Eventuali differenze fino a 1,5 cm sono dunque da considerarsi caratteristica del prodotto. The picture is purely illustrative. The graphic design of bookmatch may result in discontinuities in the veining between panels, as with the natural material. Discontinuities of up to 1.5 cm are not defects, but are characteristic of the product. Die Abbildung ist rein indikativ. Die Grafik Bookmatch kann, wie beim natürlichen Material, Unterbrechungen in der Maserung beim Übergang zwischen den Platten aufweisen. Eventuelle Unterschiede bis zu 1,5 cm gelten daher als produkttypisch. L'image est purement indicative. Le graphisme de bookmatch peut présenter une discontinuité de veine lors du passage d'une plaque à une autre, comme le matériau naturel. Les différences éventuelles jusqu'à 1,5 mm doivent donc être considérées comme une caractéristique du produit.

GRES PORCELLANATO A MASSA COLORATA\_COLOURED-BODY PORCELAIN STONEWARE

## STATUARIO WHITE



ANGOLO CLASSIC 1 LUX  
(Statuario White, Marquina Black)  
60x60 cm Rect - 24"x24"  
± 9,5 mm  
PGWENA1



FASCIA CLASSIC 1 LUX  
(Statuario White, Marquina Black)  
60x60 cm Rect - 24"x24"  
± 9,5 mm  
PGWENF1

## MARQUINA BLACK



ANGOLO CLASSIC 2 LUX  
(Marquina Black - Statuario White)  
60x60 cm Rect - 24"x24"  
± 9,5 mm  
PGWENA2



FASCIA CLASSIC 2 LUX  
(Marquina Black - Statuario White)  
60x60 cm Rect - 24"x24"  
± 9,5 mm  
PGWENF2

# Eternity

DECORI\_DECORS

GRES PORCELLANATO A MASSA COLORATA\_COLOURED-BODY PORCELAIN STONEWARE

## STATUARIO WHITE



MOSAICO 36 SOFT  
30x30 cm Rect - 12"x12"  
± 9,5 mm  
PGZEN62



MOSAICO KUBIC LUX  
17x29,2 cm Rect - 6<sup>5/8</sup>"x11<sup>1/2</sup>"  
± 9,5 mm  
PGZENK2



CHEVRON SOFT  
9,5x54 cm Rect - 3<sup>3/4</sup>"x21<sup>1/4</sup>"  
± 9,5 mm  
PGZENC2



LISTELLO LUX  
7x60 cm Rect - 2<sup>3/4</sup>"x24"  
± 9,5 mm  
PGZENL2



QUADRATO LUX  
7x7 cm Rect - 2<sup>3/4</sup>"x2<sup>3/4</sup>"  
± 9,5 mm  
PGZENQ2

## ARABESQUE PEARL



MOSAICO 36 SOFT  
30x30 cm Rect - 12"x12"  
± 9,5 mm  
PGZEN60



MOSAICO KUBIC LUX  
17x29,2 cm Rect - 6<sup>5/8</sup>"x11<sup>1/2</sup>"  
± 9,5 mm  
PGZENK0



CHEVRON SOFT  
9,5x54 cm Rect - 3<sup>3/4</sup>"x21<sup>1/4</sup>"  
± 9,5 mm  
PGZENC0



LISTELLO LUX  
7x60 cm Rect - 2<sup>3/4</sup>"x24"  
± 9,5 mm  
PGZENL0



QUADRATO LUX  
7x7 cm Rect - 2<sup>3/4</sup>"x2<sup>3/4</sup>"  
± 9,5 mm  
PGZENQ0

## BREACH GREY



MOSAICO 36 SOFT  
30x30 cm Rect - 12"x12"  
± 9,5 mm  
PGZEN61



MOSAICO KUBIC LUX  
17x29,2 cm Rect - 6<sup>5/8</sup>"x11<sup>1/2</sup>"  
± 9,5 mm  
PGZENK1



CHEVRON SOFT  
9,5x54 cm Rect - 3<sup>3/4</sup>"x21<sup>1/4</sup>"  
± 9,5 mm  
PGZENC1



LISTELLO LUX  
7x60 cm Rect - 2<sup>3/4</sup>"x24"  
± 9,5 mm  
PGZENL1



QUADRATO LUX  
7x7 cm Rect - 2<sup>3/4</sup>"x2<sup>3/4</sup>"  
± 9,5 mm  
PGZENQ1

## MARQUINA BLACK

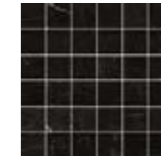

MOSAICO 36 SOFT  
30x30 cm Rect - 12"x12"  
± 9,5 mm  
PGZEN63



MOSAICO KUBIC LUX  
17x29,2 cm Rect - 6<sup>5/8</sup>"x11<sup>1/2</sup>"  
± 9,5 mm  
PGZENK3



CHEVRON SOFT  
9,5x54 cm Rect - 3<sup>3/4</sup>"x21<sup>1/4</sup>"  
± 9,5 mm  
PGZENC3



LISTELLO LUX  
7x60 cm Rect - 2<sup>3/4</sup>"x24"  
± 9,5 mm  
PGZENL3



QUADRATO LUX  
7x7 cm Rect - 2<sup>3/4</sup>"x2<sup>3/4</sup>"  
± 9,5 mm  
PGZENQ3

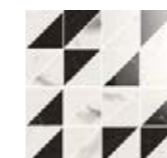

MOSAICO GEMS B LUX  
(Statuario White, Marquina Black)  
30x30 cm Rect - 12"x12"  
± 9,5 mm  
PGZEN51

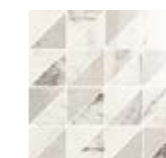

MOSAICO GEMS A LUX  
(Arabesque Pearl, Breach Grey)  
30x30 cm Rect - 12"x12"  
± 9,5 mm  
PGZEN50

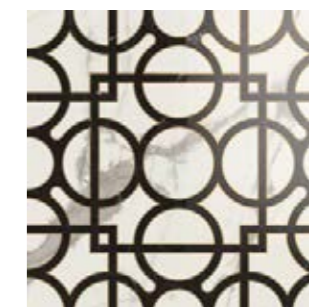

CONTEMPORARY LUX  
(Statuario White, Marquina Black)  
60x60 cm Rect - 24"x24"  
± 9,5 mm  
PGWENCO

MOSAICO KUBIC, MOSAICO GEMS A, MOSAICO GEMS B:  
Posare solo a parete\_Recommended only for wall applications\_Nur an der Wand verlegen\_Recommandé seulement pour les revêtements

# Eternity

## ESEMPI COMPOSIZIONI\_TILE LAYOUT EXAMPLES



LISTELLO Marquina Black Lux 7x60 cm Rect  
 QUADRATO Marquina Black Lux 7x7 cm Rect  
 FONDO Statuario White Lux 60x60 cm Rect



LISTELLO Arabesque Lux 7x60 cm Rect  
 QUADRATO Arabesque Lux 7x7 cm Rect  
 FONDO Marquina Black Lux 60x60 cm Rect

Per questo tipo di posa Listello e Quadrato Eternity sono abbinabili tra loro e con tutti i fondi 60x60 rettificati delle collezioni a catalogo. For this laying solution Eternity Listello and Quadrato are matchable with the 60x60 rectified of all collections. Bei dieser Art von Verlegung sind Listello und Quadrato Eternity untereinander und mit allen begradigten 60x60 Untergründen der Katalogkollektionen kombinierbar. Pour ce type de pose Listello et Quadrato Eternity sont combinables entre eux et avec tous les fonds de 60x60 rectifiés des collections du catalogue.

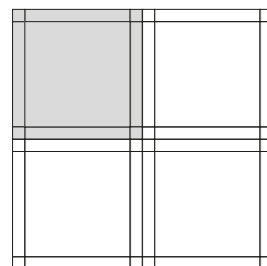

**Modulo A**\_Module A\_Modul A\_Module A  
 4 PEZZI 7x60 (30,68%)  
 4 PEZZI 7x7 (3,58%)  
 1 PEZZO 60x60 (65,74%)

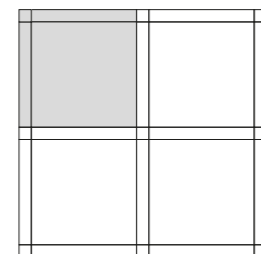

**Modulo B**\_Module B\_Modul B\_Module B  
 2 PEZZI 7x60 (18,71%)  
 1 PEZZI 7x7 (1,09%)  
 1 PEZZO 60x60 (80,20%)

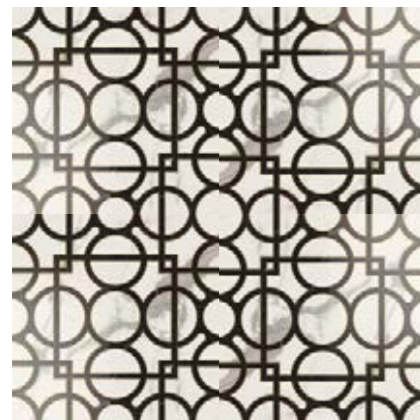

CONTEMPORARY LUX

Esempio composizione 4 pz\_4 pz composition example\_Beispiel  
 Zusammensetzung 4 Stk\_Exemple de composition 4 pièces



FASCIA E ANGOLO CLASSIC 1 LUX

Esempio composizione 6 pz\_6 pz composition example\_Beispiel  
 Zusammensetzung 6 Stk\_Exemple de composition 6 pièces



FASCIA E ANGOLO CLASSIC 2 LUX

Esempio composizione 6 pz\_6 pz composition example\_Beispiel  
 Zusammensetzung 6 Stk\_Exemple de composition 6 pièces

# Eternity

## PEZZI SPECIALI\_TRIM PIECES

GRES A MASSA COLORATA\_COLOURED-BODY STONEWARE

	BATTISCOPA 10x60 cm Rect - 4"x24" ± 10 mm		GRADINO PLUS BORDO* 34x120x4,5 cm Rect - 13 <sup>3/8</sup> "x48"x1 <sup>3/4</sup> " ± 9,5 mm		GRADINO PLUS ANGOLARE DX* 34x120x4,5 cm Rect - 13 <sup>3/8</sup> "x48"x1 <sup>3/4</sup> " ± 9,5 mm		GRADINO PLUS ANGOLARE SX* 34x120x4,5 cm Rect - 13 <sup>3/8</sup> "x48"x1 <sup>3/4</sup> " ± 9,5 mm	
	SOFT	LUX*	SOFT	LUX*	SOFT	LUX*	SOFT	LUX*
STATUARIO WHITE	PGREN20	PGREN25	PGDEN20	PGDEN70	PGDEN21	PGDEN71	PGDEN22	PGDEN72
ARABESQUE PEARL	PGREN00	PGREN05	PGDEN00	PGDEN50	PGDEN01	PGDEN51	PGDEN02	PGDEN52
BREACH GREY	PGREN10	PGREN15	PGDEN10	PGDEN60	PGDEN11	PGDEN61	PGDEN12	PGDEN62
MARQUINA BLACK	PGREN30	PGREN35	PGDEN30	PGDEN80	PGDEN31	PGDEN81	PGDEN32	PGDEN82

\* Lavorati solo su richiesta\_Manufactured only upon special request\_Nur auf Anfrage\_Seulement à la demande

## IMBALLAGGI E PESI\_PACKINGS AND WEIGHTS

DESCRIZIONE Description	± mm	FORMATI Sizes	SCATOLA_Box				PALLET		
				KG	M <sup>2</sup>	ML		KG	M <sup>2</sup>
FONDO SOFT / LUX	6	120x260 RECT	1	43,1	3,12	-	18	775,8	56,16
FONDO SOFT / LUX	6	120x120 RECT	2	39,8	2,88	-	25	995	72
BOOKMATCH A LUX	6	120x260 RECT	1	43,1	3,12	-	18	775,8	56,16
BOOKMATCH B LUX	6	120x260 RECT	1	43,1	3,12	-	18	775,8	56,16
FONDO SOFT / LUX	9,5	60x120 RECT	2	31,8	1,44	-	36	1145	51,8
FONDO SOFT / LUX	9,5	60x60 RECT	4	31,8	1,44	-	32	1018	46,1
FONDO SOFT / LUX	9,5	30x60 RECT	8	31,8	1,44	-	32	1018	46,1
MOSAICO 36 SOFT	9,5	30x30 RECT	4	7,5	0,36	-	78	585	28,8
MOSAICO KUBIC LUX	9,5	17x29,2 RECT	4	4,085	0,198	-	60	245,1	11,914
CHEVRON SOFT	9,5	9,5x54 RECT	8	9,2	0,41	-	60	553	24,6
MOSAICO GEMS A/B LUX	9,5	30x30 RECT	4	7,41	0,36	-	48	355,68	17,28
CONTEMPORARY LUX	9,5	60x60 RECT	4	31,8	1,44	-	32	1018	46,1
ANGOLO CLASSIC 1/2 LUX	9,5	60x60 RECT	4	31,8	1,44	-	-	-	-
FASCIA CLASSIC 1/2 LUX	9,5	60x60 RECT	2	15,9	0,72	-	-	-	-
LISTELLO LUX	9,5	7x60 RECT	16	13,8	0,672	-	40	551	26,9
QUADRATO LUX	9,5	7x7 RECT	16	1,6	0,078	-	456	736	35,8
BATTISCOPA SOFT / LUX	10	10x60 RECT	12	15	0,72	7,2	60	900	43,2
GRADINO PLUS BORDO SOFT / LUX	9,5	34x120x4,5	2	33,3	0,816	-	12	399	9,8
GRADINO PLUS ANGOLARE SOFT / LUX	9,5	34x120x4,5	1	16,6	0,408	-	24	399	9,8



# Trilogy



CALACATTA WHITE



ONYX LIGHT



MOON BEIGE

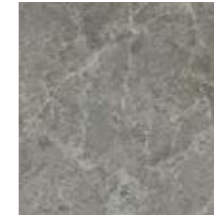

SANDY GREY



SKY SMOKE

GRES PORCELLANATO LAMINATO\_LAMINATED PORCELAIN STONEWARE **Zero.3**



± 5,5 mm



100x300 cm Rect  
39"x118"



100x100 cm Rect  
39"x39"



50x100 cm Rect  
19 1/2"x39"

MONOPOROSA IN PASTA BIANCA SMALTATA\_GLAZED WHITE BODY POROUS SINGLE-FIRED WALL TILES



± 10,5 mm



35x100 cm Rect  
13 3/4"x39"

GRES PORCELLANATO A MASSA COLORATA\_COLOURED-BODY PORCELAIN STONEWARE



± 9,5 mm



90x90 cm Rect  
36"x36"  
88x88 cm  
34 5/8"x34 5/8"



60x120 cm Rect  
24"x48"



60x60 cm Rect  
24"x24"



30x60 cm Rect  
12"x24"

RIVESTIMENTO / WALL Sandy Grey Lux 100x300 cm Rect - 39"x118"  
PAVIMENTO / FLOOR Sandy Grey Soft 60x120 cm Rect - 24"x48"



RIVESTIMENTO / WALL Moon Beige Soft 100x300 cm Rect - 39"x118"  
PAVIMENTO / FLOOR Moon Beige Soft 60x60 cm Rect - 24"x24"



RIVESTIMENTO / WALL Moon Beige 35x100 cm Rect - 13<sup>3/4</sup>"x39" Fusion Moon Beige 35x100 cm Rect - 13<sup>3/4</sup>"x39" Sky Smoke Lux 100x300 cm Rect - 39"x118"  
PAVIMENTO / FLOOR Moon Beige Lux 60x120 cm Rect - 24"x48"





RIVESTIMENTO / WALL Calacatta White Lux 100x300 cm Rect - 39"x118"  
PAVIMENTO / FLOOR Calacatta White Lux 100x100 cm Rect - 39"x39"



RIVESTIMENTO / WALL Curl Calacatta White 35x100 cm - 13<sup>3/4</sup>"x39"



RIVESTIMENTO / WALL Onyx Light 35x100 cm Rect - 13<sup>3/4</sup>"x39" \_ Swing Onyx Light 35x100 cm Rect - 13<sup>3/4</sup>"x39"  
PAVIMENTO / FLOOR Onyx Light Lux 100x100 cm Rect - 39"x39"



PAVIMENTO / FLOOR Chevron Sandy Grey Soft 9,5x54 cm Rect - 3<sup>3</sup>/<sub>4</sub>"x21<sup>1</sup>/<sub>4</sub>"



RIVESTIMENTO / WALL Mosaico Freccia Sky Smoke Soft 30x34,5 cm Rect - 12"x13<sup>3</sup>/<sub>4</sub>"

# Trilogy

**PR( )TECT**  
ANTIBATTERICO - ANTIMICROBIAL

CALACATTA WHITE



ONYX LIGHT



MOON BEIGE





SANDY GREY





SKY SMOKE



DESTINAZIONI D'USO\_INTENDED USE: SOFT / LUX  

DATI TECNICI\_TECHNICAL DATA:

GRES PORCELLANATO LAMINATO LAMINATED PORCELAIN STONEWARE	MONOPOROSA IN PASTA BIANCA SMALTATA GLAZED WHITE BODY POROUS SINGLE-FIRED WALL TILES	GRES PORCELLANATO A MASSA COLORATA COLOURED-BODY PORCELAIN STONEWARE
± 5,5 mm	10,5 mm	9,5 mm
 ANSI A326.3: DCOF ≥ 0.42 Soft	/	ANSI A326.3: DCOF ≥ 0.42 Soft
 ANSI A137.3: V2 Soft - Lux	ANSI A137.1: V2	ANSI A137.1: V2 Soft - Lux
<b>PR( )TECT</b> ANTIBATTERICO - ANTIMICROBIAL Soft	/	<b>PR( )TECT</b> ANTIBATTERICO - ANTIMICROBIAL Soft

# Trilogy

GRES PORCELLANATO LAMINATO\_LAMINATED PORCELAIN STONEWARE **Zero.3**

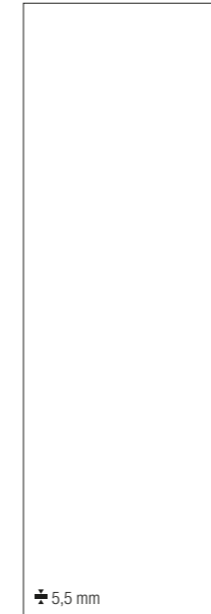

100x300 cm Rect - 39"x118"

Calacatta White SOFT	PZ7TY00
Onyx Light SOFT	PZ7TY20
Moon Beige SOFT	PZ7TY10
Sandy Grey SOFT	PZ7TY30
Sky Smoke SOFT	PZ7TY40
Calacatta White LUX	PZ7TYX0
Onyx Light LUX	PZ7TYX2
Moon Beige LUX	PZ7TYX1
Sandy Grey LUX	PZ7TYX3
Sky Smoke LUX	PZ7TYX4

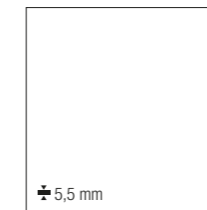

100x100 cm Rect - 39"x39"

Calacatta White SOFT	PZ8TY00
Onyx Light SOFT	PZ8TY20
Moon Beige SOFT	PZ8TY10
Sandy Grey SOFT	PZ8TY30
Sky Smoke SOFT	PZ8TY40
Calacatta White LUX	PZ8TYX0
Onyx Light LUX	PZ8TYX2
Moon Beige LUX	PZ8TYX1
Sandy Grey LUX	PZ8TYX3
Sky Smoke LUX	PZ8TYX4

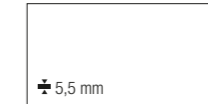

50x100 cm Rect - 19 1/2"x39"

Calacatta White SOFT	PZ9TYS0
Onyx Light SOFT	PZ9TYS2
Moon Beige SOFT	PZ9TYS1
Sandy Grey SOFT	PZ9TYS3
Sky Smoke SOFT	PZ9TYS4
Calacatta White LUX	PZ9TYX0
Onyx Light LUX	PZ9TYX2
Moon Beige LUX	PZ9TYX1
Sandy Grey LUX	PZ9TYX3
Sky Smoke LUX	PZ9TYX4

GRES PORCELLANATO A MASSA COLORATA\_COLOURED-BODY PORCELAIN STONEWARE



90x90 cm Rect - 36"x36"

Calacatta White SOFT	PGGTYS01
Moon Beige SOFT	PGGTYS11
Sandy Grey SOFT	PGGTYS31
88x88 cm - 34 5/8"x34 5/8"	
Calacatta White LUX	PGGTYL0G
Moon Beige LUX	PGGTYL1G
Sandy Grey LUX	PGGTYL3G

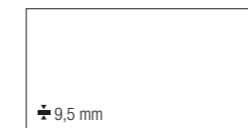

60x120 cm Rect - 24"x48"

Calacatta White SOFT	PGXTY052
Onyx Light SOFT	PGXTY252
Moon Beige SOFT	PGXTY152
Sandy Grey SOFT	PGXTY352
Sky Smoke SOFT	PGXTY452
Calacatta White LUX	PGXTY50
Onyx Light LUX	PGXTY52
Moon Beige LUX	PGXTY51
Sandy Grey LUX	PGXTY53
Sky Smoke LUX	PGXTY54



60x60 cm Rect - 24"x24"

Calacatta White SOFT	PGWTY05
Onyx Light SOFT	PGWTY25
Moon Beige SOFT	PGWTY15
Sandy Grey SOFT	PGWTY35
Sky Smoke SOFT	PGWTY45
Calacatta White LUX	PGWTY60
Onyx Light LUX	PGWTY62
Moon Beige LUX	PGWTY61
Sandy Grey LUX	PGWTY63
Sky Smoke LUX	PGWTY64



30x60 cm Rect - 12"x24"

Calacatta White SOFT	PG-TY05
Onyx Light SOFT	PG-TY25
Moon Beige SOFT	PG-TY15
Sandy Grey SOFT	PG-TY35
Sky Smoke SOFT	PG-TY45
Calacatta White LUX	PG-TY60
Onyx Light LUX	PG-TY62
Moon Beige LUX	PG-TY61
Sandy Grey LUX	PG-TY63
Sky Smoke LUX	PG-TY64

MONOPOROSA IN PASTA BIANCA SMALTATA\_GLAZED WHITE BODY POROUS SINGLE-FIRED WALL TILES

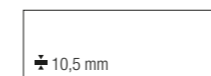

35x100 cm Rect - 13 3/4"x39"

Calacatta White	PBFTY002
Onyx Light	PBFTY202
Moon Beige	PBFTY102
Sandy Grey	PBFTY302

SOFT: Protezione antibatterica presente\_Integrated antibacterial protection\_Antibakterieller Schutz vorhanden\_Protection antibactérienne présente

# Trilogy

DECORI\_DECORS

GRES PORCELLANATO A MASSA COLORATA\_COLOURED-BODY PORCELAIN STONEWARE

CALACATTA WHITE

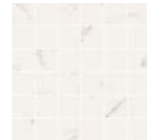

MOSAICO 36 SOFT  
30x30 cm Rect - 12"x12"  
± 9,5 mm  
PGZTY00

ONYX LIGHT



MOSAICO 36 SOFT  
30x30 cm Rect - 12"x12"  
± 9,5 mm  
PGZTY20

MOON BEIGE

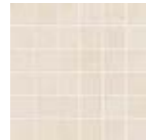

MOSAICO 36 SOFT  
30x30 cm Rect - 12"x12"  
± 9,5 mm  
PGZTY10

SANDY GREY



MOSAICO 36 SOFT  
30x30 cm Rect - 12"x12"  
± 9,5 mm  
PGZTY30

SKY SMOKE

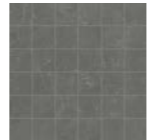

MOSAICO 36 SOFT  
30x30 cm Rect - 12"x12"  
± 9,5 mm  
PGZTY40



MOSAICO 36 LUX  
29x29 cm Rect - 11 1/2"x11 1/2"  
± 9,5 mm  
PGZTYL0



MOSAICO 36 LUX  
29x29 cm Rect - 11 1/2"x11 1/2"  
± 9,5 mm  
PGZTYL2



MOSAICO 36 LUX  
29x29 cm Rect - 11 1/2"x11 1/2"  
± 9,5 mm  
PGZTYL1



MOSAICO 36 LUX  
29x29 cm Rect - 11 1/2"x11 1/2"  
± 9,5 mm  
PGZTYL3



MOSAICO 36 LUX  
29x29 cm Rect - 11 1/2"x11 1/2"  
± 9,5 mm  
PGZTYL4



MOSAICO 72 1 LUX  
30x30 cm Rect - 12"x12"  
± 9,5 mm  
PGZTY71



MOSAICO 72 1 LUX  
30x30 cm Rect - 12"x12"  
± 9,5 mm  
PGZTY72



MOSAICO FRECCIA SOFT  
30x34,5 cm Rect - 12"x13 3/4"  
± 9,5 mm  
PGZTYE0



MOSAICO FRECCIA SOFT  
30x34,5 cm Rect - 12"x13 3/4"  
± 9,5 mm  
PGZTYE2



MOSAICO FRECCIA SOFT  
30x34,5 cm Rect - 12"x13 3/4"  
± 9,5 mm  
PGZTYE1



MOSAICO FRECCIA SOFT  
30x34,5 cm Rect - 12"x13 3/4"  
± 9,5 mm  
PGZTYE3

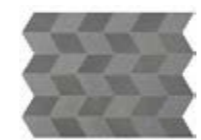

MOSAICO FRECCIA SOFT  
30x34,5 cm Rect - 12"x13 3/4"  
± 9,5 mm  
PGZTYE4



CHEVRON SOFT  
9,5x54 cm Rect - 3 3/4"x21 1/4"  
± 9,5 mm  
PGZTYC0



CHEVRON SOFT  
9,5x54 cm Rect - 3 3/4"x21 1/4"  
± 9,5 mm  
PGZTYC2



CHEVRON SOFT  
9,5x54 cm Rect - 3 3/4"x21 1/4"  
± 9,5 mm  
PGZTYC1



CHEVRON SOFT  
9,5x54 cm Rect - 3 3/4"x21 1/4"  
± 9,5 mm  
PGZTYC3



CHEVRON SOFT  
9,5x54 cm Rect - 3 3/4"x21 1/4"  
± 9,5 mm  
PGZTYC4

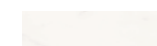

7,5x30 cm Rect - 3"x12"  
± 9,5 mm  
PGZTYM01 SOFT



7,5x30 cm Rect - 3"x12"  
± 9,5 mm  
PGZTYM21 SOFT



7,5x30 cm Rect - 3"x12"  
± 9,5 mm  
PGZTYM11 SOFT



7,5x30 cm Rect - 3"x12"  
± 9,5 mm  
PGZTYM31 SOFT



7,5x30 cm Rect - 3"x12"  
± 9,5 mm  
PGZTYM41 SOFT

MOSAICO FRECCIA:

Posare solo a parete\_Recommended only for wall applications\_Nur an der Wand verlegen\_Recommandé seulement pour les revêtements

SOFT: Protezione antibatterica presente\_Integrated antibacterial protection\_Antibakterieller Schutz vorhanden\_Protection antibactérienne présente

# Trilogy

DECORI\_DECORS

MONOPOROSA IN PASTA BIANCA SMALTATA\_GLAZED WHITE BODY POROUS SINGLE-FIRED WALL TILES

CALACATTA WHITE

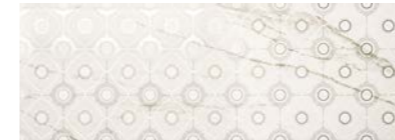

JEWEL  
35x100 cm Rect - 13 3/4"x39"  
± 10,5 mm  
PBFTYJ01

ONYX LIGHT



JEWEL  
35x100 cm Rect - 13 3/4"x39"  
± 10,5 mm  
PBFTYJ21

MOON BEIGE



JEWEL  
35x100 cm Rect - 13 3/4"x39"  
± 10,5 mm  
PBFTYJ11



FUSION  
35x100 cm Rect - 13 3/4"x39"  
± 10,5 mm  
PBFTY052



FUSION  
35x100 cm Rect - 13 3/4"x39"  
± 10,5 mm  
PBFTY252



FUSION  
35x100 cm Rect - 13 3/4"x39"  
± 10,5 mm  
PBFTY152



SWING  
35x100 cm Rect - 13 3/4"x39"  
± 10,5 mm  
PBFTYS0



SWING  
35x100 cm Rect - 13 3/4"x39"  
± 10,5 mm  
PBFTYS2



SWING  
35x100 cm Rect - 13 3/4"x39"  
± 10,5 mm  
PBFTYS1



SWING GLITTER  
35x100 cm Rect - 13 3/4"x39"  
± 10,5 mm  
PBFTYF01



SWING GLITTER  
35x100 cm Rect - 13 3/4"x39"  
± 10,5 mm  
PBFTYF21



SWING GLITTER  
35x100 cm Rect - 13 3/4"x39"  
± 10,5 mm  
PBFTYF11

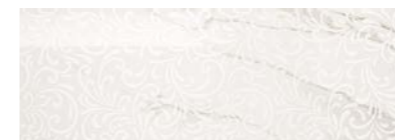

CURL  
35x100 cm Rect - 13 3/4"x39"  
± 10,5 mm  
PBFTYC01

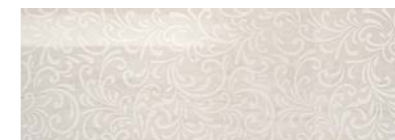

CURL  
35x100 cm Rect - 13 3/4"x39"  
± 10,5 mm  
PBFTYC21



CURL  
35x100 cm Rect - 13 3/4"x39"  
± 10,5 mm  
PBFTYC11



GLAMOUR MIX  
35x100 cm Rect - 13 3/4"x39"  
± 10,5 mm  
PBFTYG0



GLAMOUR MIX  
35x100 cm Rect - 13 3/4"x39"  
± 10,5 mm  
PBFTYG1

GLAMOUR MIX:

Sviluppato su 2 soggetti\_Developed on 2 patterns\_Paarweise entwickelt\_Developpe sur 2 éléments

# Trilogy

## DECORI\_DECORS

MONOPOROSA IN PASTA BIANCA SMALTATA\_GLAZED WHITE BODY POROUS SINGLE-FIRED WALL TILES

### SANDY GREY



**JEWEL**  
35x100 cm Rect - 13<sup>3/4</sup>"x39"  
± 10,5 mm

PBFTYJ31



**FUSION**  
35x100 cm Rect - 13<sup>3/4</sup>"x39"  
± 10,5 mm

PBFTY352



**SWING**  
35x100 cm Rect - 13<sup>3/4</sup>"x39"  
± 10,5 mm

PBFTY3

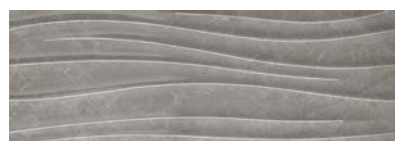

**SWING GLITTER**  
35x100 cm Rect - 13<sup>3/4</sup>"x39"  
± 10,5 mm

PBFTYF31

# Trilogy

## PEZZI SPECIALI\_TRIM PIECES

GRES PORCELLANATO A MASSA COLORATA\_COLOURED-BODY PORCELAIN STONEWARE

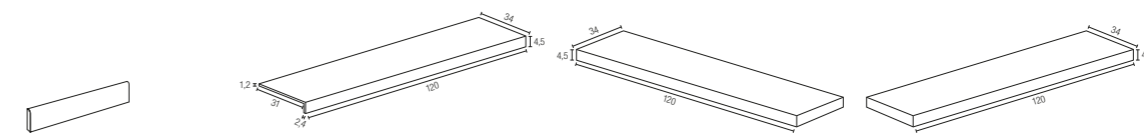

**BATTISCOPA**  
10x60 cm Rect - 4"x24"  
± 10 mm

**GRADINO PLUS BORDO\***  
34x120x4,5 cm Rect - 13<sup>3/8</sup>"x48"x1<sup>3/4</sup>"  
± 9,5 mm

**GRADINO PLUS ANGOLARE DX\***  
34x120x4,5 cm Rect - 13<sup>3/8</sup>"x48"x1<sup>3/4</sup>"  
± 9,5 mm

**GRADINO PLUS ANGOLARE SX\***  
34x120x4,5 cm Rect - 13<sup>3/8</sup>"x48"x1<sup>3/4</sup>"  
± 9,5 mm

	SOFT	LUX*	SOFT	LUX*	SOFT	LUX*	SOFT	LUX*
CALACATTA WHITE	PGRTY00	PGRTY60	PGDTY00	PGDTY55	PGDTY01	PGDTY56	PGDTY02	PGDTY57
ONYX LIGHT	PGRTY20	PGRTY62	PGDTY20	PGDTY75	PGDTY21	PGDTY76	PGDTY22	PGDTY77
MOON BEIGE	PGRTY10	PGRTY61	PGDTY10	PGDTY65	PGDTY11	PGDTY66	PGDTY12	PGDTY67
SANDY GREY	PGRTY30	PGRTY63	PGDTY30	PGDTY85	PGDTY31	PGDTY86	PGDTY32	PGDTY87
SKY SMOKE	PGRTY40	PGRTY64	PGDTY40	PGDTY95	PGDTY41	PGDTY96	PGDTY42	PGDTY97

\* Lavorati solo su richiesta\_Manufactured only upon special request\_Nur auf Anfrage\_Seulement à la demande

SOFT: Protezione antibatterica presente\_Integrated antibacterial protection\_Antibakterieller Schutz vorhanden\_Protection antibactérienne présente

MONOPOROSA IN PASTA BIANCA SMALTATA\_GLAZED WHITE BODY POROUS SINGLE-FIRED WALL TILES



**SPIGOLO**  
1x35 cm Rect - 3/8"x13<sup>3/4</sup>"  
± 10 mm

**TORELLO**  
5x35 cm Rect - 2"x13<sup>3/4</sup>"  
± 10 mm

**ANGOLO ESTERNO TORELLO**  
2x5 cm - 3/4"x2"

**ALZATA**  
12,5x35 cm - 5"x13<sup>3/4</sup>"  
± 10 mm

**ANGOLO ESTERNO ALZATA**  
2x12,5 cm - 3/4"x5"

CALACATTA WHITE	PBZTY00	PBZTY01	PBZTY03	PBZTY02	PBZTY04
ONYX LIGHT	PBZTY20	PBZTY21	PBZTY23	PBZTY22	PBZTY24
MOON BEIGE	PBZTY10	PBZTY11	PBZTY13	PBZTY12	PBZTY14

## IMBALLAGGI E PESI\_PACKINGS AND WEIGHTS

DESCRIZIONE Description	± mm	FORMATI Sizes	SCATOLA_Box				PALLET			
FONDO SOFT / LUX	5,5	100x300 <sup>RECT</sup>	1	34,5	3	-	13	448,5	39	
FONDO SOFT / LUX	5,5	100x100 <sup>RECT</sup>	2	23	2	-	25	575	50	
FONDO SOFT / LUX	5,5	50x100 <sup>RECT</sup>	3	18,9	1,5	-	32	604,8	48	
FONDO SOFT	9,5	90x90 <sup>RECT</sup>	2	33,6	1,62	-	25	840	40,5	
FONDO LUX	9,5	88x88 <sup>RECT</sup>	2	33,6	1,549	-	25	840	38,72	
FONDO SOFT / LUX	9,5	60x120 <sup>RECT</sup>	2	31,8	1,44	-	36	1144,8	51,84	
FONDO SOFT / LUX	9,5	60x60 <sup>RECT</sup>	4	31,8	1,44	-	32	1017,6	46,08	
FONDO SOFT / LUX	9,5	30x60 <sup>RECT</sup>	8	31,8	1,44	-	32	1017,6	46,08	
MOSAICO 36 SOFT	9,5	30x30 <sup>RECT</sup>	4	7,5	0,36	-	78	585	28,08	
MOSAICO 36 LUX	9,5	29x29 <sup>RECT</sup>	4	7,13	0,336	-	60	427,5	20,18	
MOSAICO FRECCIA SOFT	9,5	30x34,5 <sup>RECT</sup>	4	9,3	0,414	-	-	-	-	
MOSAICO 72 1/2 LUX	9,5	30x30 <sup>RECT</sup>	4	7,5	0,36	-	78	585	28,08	
CHEVRON SOFT	9,5	9,5x54 <sup>RECT</sup>	8	9,2	0,407	-	64	589,76	26,02	
FONDO SOFT	9,5	7,5x30 <sup>RECT</sup>	16	7,6	0,36	-	84	638,4	30,24	
BATTISCOPA SOFT / LUX	10	10x60 <sup>RECT</sup>	12	15	0,72	7,2	60	900	43,2	
GRADINO PLUS BORDO SOFT / LUX	9,5	34x120x4,5	2	33,25	0,816	-	12	399	9,79	
GRADINO PLUS ANGOLARE SOFT / LUX	9,5	34x120x4,5	1	16,63	0,408	-	24	399	9,79	
FONDO	10,5	35x100 <sup>RECT</sup>	3	20,15	1,05	-	28	564,2	29,4	
JEWEL	10,5	35x100 <sup>RECT</sup>	3	19,8	1,05	-	12	237,6	12,6	
FUSION	10,5	35x100 <sup>RECT</sup>	3	20,15	1,05	-	26	523,9	27,3	
CURL	10,5	35x100 <sup>RECT</sup>	3	19,8	1,05	-	12	237,6	12,6	
SWING	10,5	35x100 <sup>RECT</sup>	3	20,15	1,05	-	26	523,9	27,3	
SWING GLITTER	10,5	35x100 <sup>RECT</sup>	3	19,8	1,05	-	12	237,6	12,6	
GLAMOUR MIX	10,5	35x100 <sup>RECT</sup>	2	13,2	0,7	-	18	237,6	12,6	
SPIGOLO	10	1x35 <sup>RECT</sup>	8	0,8	0,028	-	-	-	-	
TORELLO	10	5x35 <sup>RECT</sup>	6	1,8	0,105	-	-	-	-	
ANGOLO ESTERNO TORELLO	-	2x5	4	0,2	0,004	-	-	-	-	
ALZATA	10	12,5x35 <sup>RECT</sup>	6	3,6	0,262	-	-	-	-	
ANGOLO ESTERNO ALZATA	-	2x12,5	4	0,4	0,01	-	-	-	-	



# Effetto legno



Wood look\_Holz-Optik\_Effet bois



# Assi d'Alpe



CHALET



BADIA



CIASA



MASO



STUBE

GRES PORCELLANATO A MASSA COLORATA\_COLOURED-BODY PORCELAIN STONEWARE



± 9,5 mm



20x90,5 cm  
8"x36"





PAVIMENTO / FLOOR Badia Naturale 20x90,5 cm - 8"x36"



PAVIMENTO / FLOOR Chalet Naturale 20x90,5 cm - 8"x36"



PAVIMENTO / FLOOR Ciasa Naturale 20x90,5 cm - 8"x36"



PAVIMENTO / FLOOR Maso Naturale 20x90,5 cm - 8"x36"

# Assi d'Alpe

CHALET



BADIA



CIASA



MASO



STUBE



DESTINAZIONI D'USO\_INTENDED USE: NATURALE   

DATI TECNICI\_TECHNICAL DATA:

**GRES PORCELLANATO A MASSA COLORATA**  
COLOURED-BODY PORCELAIN STONEWARE

± 9,5 mm

 DIN 51130: **R10** Naturale  
DIN 51097: **A** Naturale  
BCR TORTUS:  $\mu > 0,40$  Naturale  
ANSI A326.3: **DCOF  $\geq 0,42$**  Naturale

 ANSI A137.1: **V2** Naturale (Badia-Ciasa-Chalet)  
**V3** Naturale (Stube-Maso)

**PR( )TECT**<sup>®</sup> Naturale  
ANTIBATTERICO - ANTIMICROBIAL

\* Per ordini superiori ai 1.000 Mq può essere richiesta la protezione antibatterica con una maggiorazione di 2,5€ netti al Mq. For orders above 1.000 Sqm the anti-bacterial protection may be requested and added, with a €2,50/Sqm net price increase. Sie koennen den antibakterielle Hygieneschutz von nachfragen für alle Aufträge ab 1000 QM, mit einer Preiserhöhung von Euro 2,50/QM netto. Pour commandes supérieures à 1.000 m<sup>2</sup> vous pouvez demander la protection antibactérienne avec un prix majoré de 2,5 Euro net/m<sup>2</sup>

# Assi d'Alpe

**GRES PORCELLANATO A MASSA COLORATA**\_COLOURED-BODY PORCELAIN STONEWARE

± 9,5 mm

20x90,5 cm - 8"x36"

Chalet NATURALE PG2DA001  
Badia NATURALE PG2DA301  
Ciasa NATURALE PG2DA201  
Maso NATURALE PG2DA401  
Stube NATURALE PG2DA101

**PEZZI SPECIALI**\_TRIM PIECES



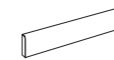



**GRES PORCELLANATO A MASSA COLORATA**\_COLOURED-BODY PORCELAIN STONEWARE



**BATTISCOPA**  
10x60,3 cm - 4"x24"  
± 10 mm  
NATURALE

CHALET	PGRDA00
BADIA	PGRDA30
CIASA	PGRDA20
MASO	PGRDA40
STUBE	PGRDA10

**IMBALLAGGI E PESI**\_PACKINGS AND WEIGHTS

DESCRIZIONE Description	± mm	FORMATI Sizes	SCATOLA_Box				PALLET			
										
FONDO NATURALE	9,5	20x90,5	6	23,4	1,086	-	48	1123,2	52,128	
BATTISCOPA NATURALE	10	10x60,3	16	20	0,9648	9,648	48	960	46,3104	



# Borealis



INARI



ABISKO



DONEGAL



ALTA

GRES PORCELLANATO A MASSA COLORATA\_COLOURED-BODY PORCELAIN STONEWARE



± 10,5 mm  
± 9,5 mm



30x180 cm Rect  
12"x71"

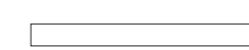

20x180 cm Rect  
8"x71"



20x120 cm Rect  
8"x48"

GRES PORCELLANATO A MASSA COLORATA\_COLOURED-BODY PORCELAIN STONEWARE **20 mm**



± 20 mm



40x120 cm Rect  
16"x48"



PAVIMENTO / FLOOR Abisko Naturale 20x120 cm Rect - 8"x48" \_Abisko Strutturato 40x120 cm Rect - 16"x48" 20 mm



PAVIMENTO / FLOOR Alta Naturale 20x120 cm Rect - 8"x48"



PAVIMENTO / FLOOR Listello Inari Naturale 6,5x60 cm Rect - 2 1/2"x24"



PAVIMENTO / FLOOR Donegal Naturale 20x180 cm Rect - 8"x71" \_30x180 cm Rect - 12"x71"  
Donegal Strutturato 40x120 cm Rect - 16"x48" 20 mm



PAVIMENTO / FLOOR Baroque Donegal Naturale 60x60 cm Rect - 24"x24"

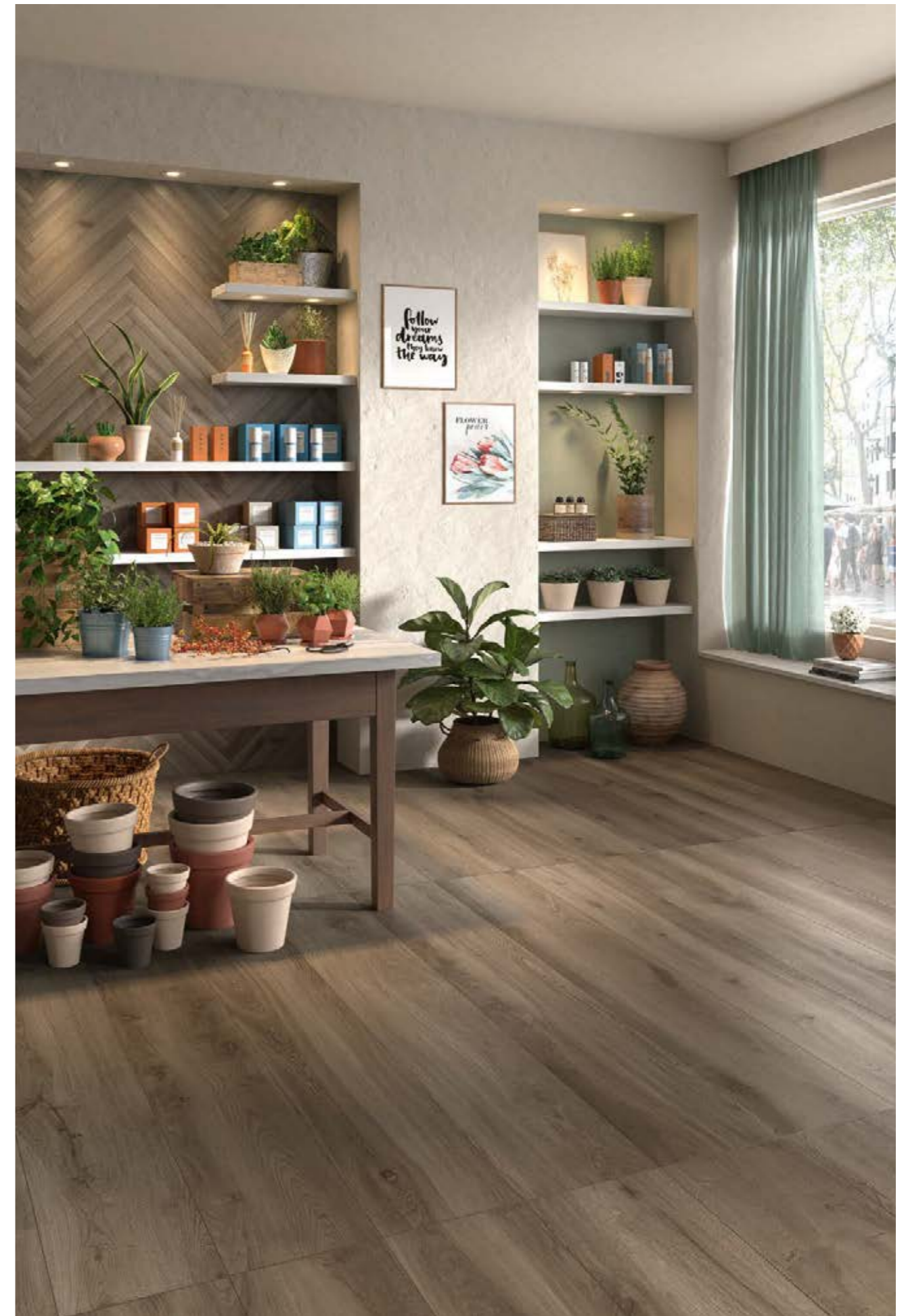

RIVESTIMENTO / WALL Listello Alta Naturale 6,5x60 cm Rect - 2 1/2"x24"  
PAVIMENTO / FLOOR Alta Naturale 30x180 cm Rect - 12"x71"



# Borealis

**PROTECT**  
ANTIBATTERICO - ANTIMICROBIAL

## INARI



## ABISKO



## DONEGAL



## ALTA



# Borealis

## GRES PORCELLANATO A MASSA COLORATA\_COLOURED-BODY PORCELAIN STONEWARE

± 10,5 mm

30x180 cm Rect - 12"x71"

Inari NATURALE PGIBE301  
Abisko NATURALE PGIBE001  
Donegal NATURALE PGIBE201  
Alta NATURALE PGIBE101

± 10,5 mm

20x180 cm Rect - 8"x71"

Inari NATURALE PG4BE30  
Abisko NATURALE PG4BE00  
Donegal NATURALE PG4BE20  
Alta NATURALE PG4BE10

± 9,5 mm

20x120 cm Rect - 8"x48"

Inari NATURALE PGOBE30  
Abisko NATURALE PGOBE00  
Donegal NATURALE PGOBE20  
Alta NATURALE PGOBE10  
Inari EXT\* PGOBE35  
Abisko EXT\* PGOBE05  
Donegal EXT\* PGOBE25  
Alta EXT\* PGOBE15

## GRES PORCELLANATO A MASSA COLORATA\_COLOURED-BODY PORCELAIN STONEWARE **20 mm**

± 20 mm

40x120 cm Rect - 16"x48"

Inari STRUTTURATO\* PG9BE301  
Abisko STRUTTURATO\* PG9BE001  
Donegal STRUTTURATO\* PG9BE201  
Alta STRUTTURATO\* PG9BE101

DESTINAZIONI D'USO\_INTENDED USE: NATURALE STRUTTURATO

### DATI TECNICI\_TECHNICAL DATA:

GRES PORCELLANATO A MASSA COLORATA COLOURED-BODY PORCELAIN STONEWARE	GRES PORCELLANATO A MASSA COLORATA COLOURED-BODY PORCELAIN STONEWARE
± 10,5 / 9,5 mm	20 mm
DIN 51130: R10 Naturale R11 Ext DIN 51097: C (A+B+C) Ext BCR TORTUS: $\mu > 0,40$ Naturale - Ext ANSI A326.3: DCOF $\geq 0,42$ Naturale - Ext AS/NZS 4586: P4 Ext BS 7976-2: PTV 36+WET (SI.96 - SI.55) Ext	DIN 51130: R11 Strutturato DIN 51097: C (A+B+C) Strutturato BCR TORTUS: $\mu > 0,40$ Strutturato ANSI A326.3: DCOF $\geq 0,42$ Strutturato AS/NZS 4586: P4 Strutturato BS 7976-2: PTV 36+WET (SI.96 - SI.55) Strutturato
ANSI A137.1: V3 Naturale - Ext	ANSI A137.1: V3 Strutturato
<b>PROTECT</b> ANTIBATTERICO - ANTIMICROBIAL Naturale	

\* Protezione antibatterica non presente\_No antimicrobial protection\_Der Antibakterielle Schutz nicht vorhanden\_Protection antibactérienne pas présente

# Borealis

## DECORI\_DECORS

GRES PORCELLANATO A MASSA COLORATA\_COLOURED-BODY PORCELAIN STONWARE

### INARI



**BAROQUE NATURALE**  
60x60 cm Rect - 24"x24"  
± 9,5 mm  
PGWBE30

### ABISKO



**BAROQUE NATURALE**  
60x60 cm Rect - 24"x24"  
± 9,5 mm  
PGWBE00

### DONEGAL



**BAROQUE NATURALE**  
60x60 cm Rect - 24"x24"  
± 9,5 mm  
PGWBE20

### ALTA



**BAROQUE NATURALE**  
60x60 cm Rect - 24"x24"  
± 9,5 mm  
PGWBE10



**PLANKS NATURALE**  
60x60 cm Rect - 24"x24"  
± 9,5 mm  
PGWBE80



**PLANKS NATURALE**  
60x60 cm Rect - 24"x24"  
± 9,5 mm  
PGWBE50



**PLANKS NATURALE**  
60x60 cm Rect - 24"x24"  
± 9,5 mm  
PGWBE70



**CHEVRON NATURALE**  
20x98 cm Rect - 8"x38<sup>5/8"</sup>  
± 9,5 mm  
PG2BE30



**CHEVRON NATURALE**  
20x98 cm Rect - 8"x38<sup>5/8"</sup>  
± 9,5 mm  
PG2BE00



**CHEVRON NATURALE**  
20x98 cm Rect - 8"x38<sup>5/8"</sup>  
± 9,5 mm  
PG2BE20



**CHEVRON NATURALE**  
20x98 cm Rect - 8"x38<sup>5/8"</sup>  
± 9,5 mm  
PG2BE10



**LISTELLO NATURALE**  
6,5x60 cm Rect - 2<sup>1/2"</sup>x24"  
± 9,5 mm  
PGTBE30



**LISTELLO NATURALE**  
6,5x60 cm Rect - 2<sup>1/2"</sup>x24"  
± 9,5 mm  
PGTBE00



**LISTELLO NATURALE**  
6,5x60 cm Rect - 2<sup>1/2"</sup>x24"  
± 9,5 mm  
PGTBE20



**LISTELLO NATURALE**  
6,5x60 cm Rect - 2<sup>1/2"</sup>x24"  
± 9,5 mm  
PGTBE10

# Borealis

## PEZZI SPECIALI\_TRIM PIECES

GRES PORCELLANATO A MASSA COLORATA\_COLOURED-BODY PORCELAIN STONWARE

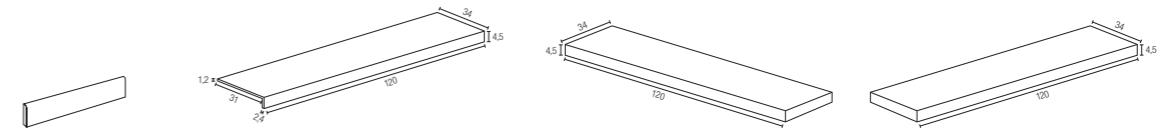

**BATTISCOPA**  
7,5x60 cm - 3"x24"  
± 10 mm  
NATURALE

**GRADINO PLUS BORDO**  
34x120x4,5 cm Rect - 13<sup>3/8"</sup>x48"x1<sup>3/4"</sup>  
± 9,5 mm  
NATURALE

**GRADINO PLUS ANGOLARE DX**  
34x120x4,5 cm Rect - 13<sup>3/8"</sup>x48"x1<sup>3/4"</sup>  
± 9,5 mm  
NATURALE

**GRADINO PLUS ANGOLARE SX**  
34x120x4,5 cm Rect - 13<sup>3/8"</sup>x48"x1<sup>3/4"</sup>  
± 9,5 mm  
NATURALE

INARI	PGRBE30	PGDBE30	PGDBE31	PGDBE32
ABISKO	PGRBE00	PGDBE00	PGDBE01	PGDBE02
DONEGAL	PGRBE20	PGDBE20	PGDBE21	PGDBE22
ALTA	PGRBE10	PGDBE10	PGDBE11	PGDBE12

GRES PORCELLANATO A MASSA COLORATA\_COLOURED-BODY PORCELAIN STONWARE **20 mm**

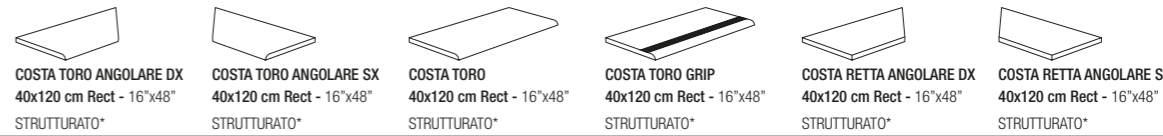

**COSTA TORO ANGOLARE DX**  
40x120 cm Rect - 16"x48"  
STRUTTURATO\*

**COSTA TORO ANGOLARE SX**  
40x120 cm Rect - 16"x48"  
STRUTTURATO\*

**COSTA TORO**  
40x120 cm Rect - 16"x48"  
STRUTTURATO\*

**COSTA TORO GRIP**  
40x120 cm Rect - 16"x48"  
STRUTTURATO\*

**COSTA RETTA ANGOLARE DX**  
40x120 cm Rect - 16"x48"  
STRUTTURATO\*

**COSTA RETTA ANGOLARE SX**  
40x120 cm Rect - 16"x48"  
STRUTTURATO\*

INARI	PGDBEK3	PGDBEK7	PGDBEF3	PGDBEJ3	PGDBED3	PGDBED7
ABISKO	PGDBEK0	PGDBEK4	PGDBEF0	PGDBEJ0	PGDBED0	PGDBED4
DONEGAL	PGDBEK2	PGDBEK6	PGDBEF2	PGDBEJ2	PGDBED2	PGDBED4
ALTA	PGDBEK1	PGDBEK5	PGDBEF1	PGDBEJ1	PGDBED1	PGDBED5

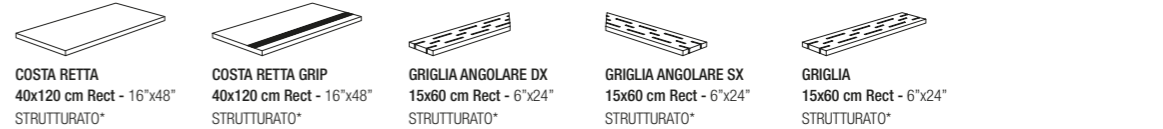

**COSTA RETTA**  
40x120 cm Rect - 16"x48"  
STRUTTURATO\*

**COSTA RETTA GRIP**  
40x120 cm Rect - 16"x48"  
STRUTTURATO\*

**GRIGLIA ANGOLARE DX**  
15x60 cm Rect - 6"x24"  
STRUTTURATO\*

**GRIGLIA ANGOLARE SX**  
15x60 cm Rect - 6"x24"  
STRUTTURATO\*

**GRIGLIA**  
15x60 cm Rect - 6"x24"  
STRUTTURATO\*

INARI	PGDBEC3	PGDBEG3	PGDBEA6	PGDBEA7	PGDBEZ3
ABISKO	PGDBEC0	PGDBEG0	PGDBEA0	PGDBEA1	PGDBEZ0
DONEGAL	PGDBEC2	PGDBEG2	PGDBEA4	PGDBEA5	PGDBEZ2
ALTA	PGDBEC1	PGDBEG1	PGDBEA2	PGDBEA3	PGDBEZ1

\* Protezione antibatterica non presente\_No antimicrobial protection\_Der Antibakterielle Schutz nicht vorhanden\_Protection antibactérienne pas présente

## IMBALLAGGI E PESI\_PACKINGS AND WEIGHTS

DESCRIZIONE Description	± mm	FORMATI Sizes	SCATOLA_Box				PALLET		
				KG	M <sup>2</sup>	ML		KG	M <sup>2</sup>
FONDO NATURALE / EXT	9,5	20x120 RECT	5	25	1,2	-	24	600	28,8
FONDO NATURALE	10,5	20x180 RECT	3	25,5	1,08	-	48	1224	51,84
FONDO NATURALE	10,5	30x180 RECT	2	25,5	1,08	-	36	918	48,6
BAROQUE NATURALE	9,5	60x60 RECT	4	32	1,44	-	28	896	40,32
PLANKS NATURALE	9,5	60x60 RECT	4	31,8	1,44	-	32	1017,6	46,08
CHEVRON NATURALE	9,5	20x98 RECT	4	16	0,784	-	30	480	23,52
LISTELLO NATURALE	9,5	6,5x60 RECT	15	11	0,585	-	91	1001	53,235
BATTISCOPA NATURALE	10	7,5x60 RECT	12	11,61	0,54	7,2	60	696,6	32,4
GRADINO PLUS BORDO NATURALE	9,5	34x120x4,5 RECT	2	33,25	0,816	-	12	399	9,792
GRADINO PLUS ANGOLARE NATURALE	9,5	34x120x4,5 RECT	1	16,625	0,408	-	24	399	9,792
FONDO STRUTTURATO	20	40x120 RECT	2	46	0,96	-	20	920	30,72
COSTA TORO STRUTTURATO	20	40x120 RECT	1	23	0,48	-	-	-	-
COSTA TORO ANGOLARE STRUTTURATO	20	40x120 RECT	1	21	0,4	-	-	-	-
COSTA TORO GRIP STRUTTURATO	20	40x120 RECT	1	23	0,48	-	-	-	-
COSTA RETTA STRUTTURATO	20	40x120 RECT	1	23	0,48	-	-	-	-
COSTA RETTA ANGOLARE STRUTTURATO	20	40x120 RECT	1	21	0,4	-	-	-	-
COSTA RETTA GRIP STRUTTURATO	20	40x120 RECT	1	23	0,48	-	-	-	-
GRIGLIA STRUTTURATO	20	15x60 RECT	2	8	0,18	-	100	800	15,8
GRIGLIA ANGOLARE STRUTTURATO	20	15x60 RECT	2	7	0,158	-	100	700	15,8



# Cross Wood



BONE



BUFF



DUST



CINDER



EBONY

GRES PORCELLANATO A MASSA COLORATA\_COLOURED-BODY PORCELAIN STONEWARE



± 9,5 mm

20x121,5 cm  
8"x48"

GRES PORCELLANATO A MASSA COLORATA\_COLOURED-BODY PORCELAIN STONEWARE **20 mm**



± 20 mm

30x120 cm Rect  
12"x48"



PAVIMENTO / FLOOR Buff Naturale 20x121,5 cm - 8"x48"



PAVIMENTO / FLOOR Bone Naturale 20x121,5 cm - 8"x48"



RIVESTIMENTO / WALL Experience 0.3 Nero Puro Naturale 100x300 cm Rect - 39"x118"  
PAVIMENTO / FLOOR Ebony Naturale 20x121,5 cm - 8"x48"



PAVIMENTO / FLOOR Dust Strutturato 30x120 cm Rect - 12"x48" 20 mm

# Cross Wood

BONE



BUFF



DUST



CINDER



EBONY



DESTINAZIONI D'USO\_INTENDED USE: NATURALE EXT STRUTTURATO

DATI TECNICI\_TECHNICAL DATA:

GRES PORCELLANATO A MASSA COLORATA COLOURED-BODY PORCELAIN STONEWARE		GRES PORCELLANATO A MASSA COLORATA COLOURED-BODY PORCELAIN STONEWARE	
9,5 mm		20 mm	
DIN 51130: R10 Naturale R11 Ext DIN 51097: C (A+B+C) Ext BCR TORTUS: $\mu > 0,40$ Naturale - Ext ANSI A326.3: DCOF $\geq 0,42$ Naturale - Ext AS/NZS 4586: P4 Ext UNE 41901 EX: CLASE 3 Ext BS 7976-2: PTV 36+WET (Sl.96 - Sl.55) Ext	DIN 51130: R11 Strutturato DIN 51097: C (A+B+C) Strutturato BCR TORTUS: $\mu > 0,40$ Strutturato ANSI A326.3: DCOF $\geq 0,42$ Strutturato AS/NZS 4586: P4 Strutturato UNE 41901 EX: CLASE 3 Strutturato BS 7976-2: PTV 36+WET (Sl.96 - Sl.55) Strutturato	ANSI A137.1: V2 Naturale - Ext (Bone) V3 Naturale - Ext (Buff-Cinder-Dust-Ebony)	ANSI A137.1: V3 Strutturato

# Cross Wood

GRES PORCELLANATO A MASSA COLORATA\_COLOURED-BODY PORCELAIN STONEWARE

9,5 mm

20x121,5 cm - 8"x48"

Bone NATURALE	PG0CW00
Buff NATURALE	PG0CW10
Dust NATURALE	PG0CW40
Cinder NATURALE	PG0CW30
Ebony NATURALE	PG0CW20
Buff EXT	PG0CWS1
Dust EXT	PG0CWS4
Cinder EXT	PG0CWS3
Ebony EXT	PG0CWS2

GRES PORCELLANATO A MASSA COLORATA\_COLOURED-BODY PORCELAIN STONEWARE **20 mm**

20 mm

30x120 cm Rect - 12"x48"

Buff STRUTTURATO	PG6CW101
Dust STRUTTURATO	PG6CW401
Cinder STRUTTURATO	PG6CW301

## PEZZI SPECIALI\_TRIM PIECES

GRES PORCELLANATO A MASSA COLORATA\_COLOURED-BODY PORCELAIN STONEWARE

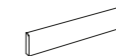

BATTISCOPA  
10x60,3 cm - 4"x24"  
10 mm  
NATURALE

BONE	PGRCW00
BUFF	PGRCW10
DUST	PGRCW40
CINDER	PGRCW30
EBONY	PGRCW20

GRES PORCELLANATO A MASSA COLORATA\_COLOURED-BODY PORCELAIN STONEWARE **20 mm**



COSTA TORO ANGOLARE DX  
30x60 cm Rect - 12"x24"  
STRUTTURATO



COSTA TORO ANGOLARE SX  
30x60 cm Rect - 12"x24"  
STRUTTURATO



COSTA TORO  
30x60 cm Rect - 12"x24"  
STRUTTURATO

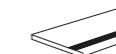

COSTA TORO GRIP  
30x60 cm Rect - 12"x24"  
STRUTTURATO

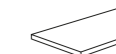

COSTA RETTA ANGOLARE DX  
30x60 cm Rect - 12"x24"  
STRUTTURATO

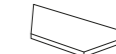

COSTA RETTA ANGOLARE SX  
30x60 cm Rect - 12"x24"  
STRUTTURATO

BUFF	PGDCWK1	PGDCWK6	PGDCWF1	PGDCWJ1	PGDCWD1	PGDCWD6
DUST	PGDCWK4	PGDCWK8	PGDCWF4	PGDCWJ4	PGDCWD4	PGDCWD8
CINDER	PGDCWK3	PGDCWK7	PGDCWF3	PGDCWJ3	PGDCWD3	PGDCWD7

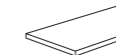

COSTA RETTA  
30x60 cm Rect - 12"x24"  
STRUTTURATO



COSTA RETTA GRIP  
30x60 cm Rect - 12"x24"  
STRUTTURATO



GRIGLIA ANGOLARE DX  
15x60 cm Rect - 6"x24"  
STRUTTURATO



GRIGLIA ANGOLARE SX  
15x60 cm Rect - 6"x24"  
STRUTTURATO



GRIGLIA  
15x60 cm Rect - 6"x24"  
STRUTTURATO

BUFF	PGDCWC1	PGDCWG1	PGDCWA1	PGDCWA6	PGDCWZ1
DUST	PGDCWC4	PGDCWG4	PGDCWA4	PGDCWA8	PGDCWZ4
CINDER	PGDCWC3	PGDCWG3	PGDCWA3	PGDCWA7	PGDCWZ3

## IMBALLAGGI E PESI\_PACKINGS AND WEIGHTS

DESCRIZIONE Description	mm	FORMATI Sizes	SCATOLA_Box				PALLET			
FONDO NATURALE / EXT	9,5	20x121,5	5	27,3	1,22	-	24	655	29,2	
BATTISCOPA NATURALE	10	10x60,3	16	20	0,9648	9,648	48	960	46,31	
FONDO STRUTTURATO	20	30x120 <sup>RECT</sup>	2	33,25	0,72	-	32	1064	23,04	
COSTA TORO STRUTTURATO	20	30x60 <sup>RECT</sup>	1	8,13	0,135	-	100	813	13,5	
COSTA TORO ANGOLARE STRUTTURATO	20	30x60 <sup>RECT</sup>	1	6,1	0,135	-	100	610	13,5	
COSTA TORO GRIP STRUTTURATO	20	30x60 <sup>RECT</sup>	1	8,13	0,135	-	100	813	13,5	
COSTA RETTA STRUTTURATO	20	30x60 <sup>RECT</sup>	1	8,13	0,135	-	100	813	13,5	
COSTA RETTA ANGOLARE STRUTTURATO	20	30x60 <sup>RECT</sup>	1	6,1	0,135	-	100	610	13,5	
COSTA RETTA GRIP STRUTTURATO	20	30x60 <sup>RECT</sup>	1	8,13	0,135	-	100	813	13,5	
GRIGLIA STRUTTURATO	20	15x60 <sup>RECT</sup>	2	8	0,158	-	100	800	15,8	
GRIGLIA ANGOLARE STRUTTURATO	20	15x60 <sup>RECT</sup>	2	7	0,158	-	100	700	15,8	



# North Cape



REISA



DROVE



RONDANE



GUTULIA

GRES PORCELLANATO A MASSA COLORATA\_COLOURED-BODY PORCELAIN STONEWARE



± 10,5 mm  
± 9,5 mm



30x180 cm Rect  
12"x71"

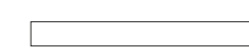

20x180 cm Rect  
8"x71"



20x90,5 cm  
8"x36"





PAVIMENTO / FLOOR Drove Naturale 30x180 cm Rect - 12"x71" \_20x180 cm Rect - 8"x71"



PAVIMENTO / FLOOR Rondane Naturale 30x180 cm Rect - 12"x71"

# North Cape

**PROTECT**  
ANTIBATTERICO - ANTIMICROBIAL

## REISA



## DROVE



## RONDANE



## GUTULIA



# North Cape

**GRES PORCELLANATO A MASSA COLORATA**\_COLOURED-BODY PORCELAIN STONWARE

± 10,5 mm

30x180 cm Rect - 12"x71"

Reisa NATURALE PGICN202  
Drove NATURALE PGICN002  
Rondane NATURALE PGICN302  
Gutulia NATURALE PGICN102

± 10,5 mm

20x180 cm Rect - 8"x71"

Reisa NATURALE PG4CN20G  
Drove NATURALE PG4CN00G  
Rondane NATURALE PG4CN30G  
Gutulia NATURALE PG4CN10G

± 9,5 mm

20x90,5 cm - 8"x36"

Reisa NATURALE\* PG2NC20  
Drove NATURALE\* PG2NC00  
Rondane NATURALE\* PG2NC30  
Gutulia NATURALE\* PG2NC10

\* Protezione antibatterica non presente\_No antimicrobial protection\_Der Antibakterielle Schutz nicht vorhanden\_Protection antibactérienne pas présente

## PEZZI SPECIALI\_TRIM PIECES

**GRES PORCELLANATO A MASSA COLORATA**\_COLOURED-BODY PORCELAIN STONWARE

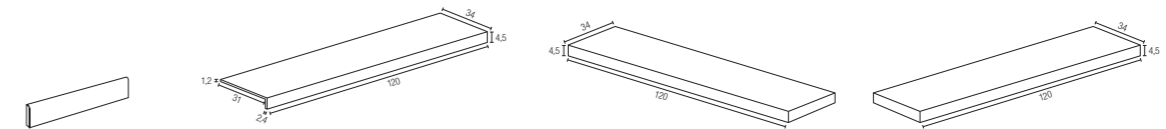

**BATTISCOPA**  
10x60,3 cm - 4"x24"  
± 10 mm  
NATURALE

**GRADINO PLUS BORDO**  
34x120x4,5 cm Rect - 13<sup>3/8</sup>"x48"x1<sup>3/4</sup>"  
± 10,5 mm  
NATURALE

**GRADINO PLUS ANGOLARE DX**  
34x120x4,5 cm Rect - 13<sup>3/8</sup>"x48"x1<sup>3/4</sup>"  
± 10,5 mm  
NATURALE

**GRADINO PLUS ANGOLARE SX**  
34x120x4,5 cm Rect - 13<sup>3/8</sup>"x48"x1<sup>3/4</sup>"  
± 10,5 mm  
NATURALE

REISA	PGRNC20	PGDNC20G	PGDNC21G	PGDNC22G
DROVE	PGRNC00	PGDNC00G	PGDNC01G	PGDNC02G
RONDANE	PGRNC30	PGDNC30G	PGDNC31G	PGDNC32G
GUTULIA	PGRNC10	PGDNC10G	PGDNC11G	PGDNC12G

DESTINAZIONI D'USO\_INTENDED USE: NATURALE

DATI TECNICI\_TECHNICAL DATA:

	GRES PORCELLANATO A MASSA COLORATA COLOURED-BODY PORCELAIN STONWARE	GRES PORCELLANATO A MASSA COLORATA COLOURED-BODY PORCELAIN STONWARE
±	9,5 mm	10,5 mm
	DIN 51130: R9 Naturale BCR TORTUS: $\mu > 0,40$ Naturale ANSI A326.3: DCOF $\geq 0,42$ Naturale	DIN 51130: R9 Naturale BCR TORTUS: $\mu > 0,40$ Naturale ANSI A326.3: DCOF $\geq 0,42$ Naturale
	ANSI A137.1: V2 Naturale (Rondane) V3 Naturale (Gutulia-Drove-Reisa)	ANSI A137.1: V2 Naturale (Rondane) V3 Naturale (Gutulia-Drove-Reisa)
	<b>PROTECT</b> ANTIBATTERICO - ANTIMICROBIAL Naturale	

## IMBALLAGGI E PESI\_PACKINGS AND WEIGHTS

DESCRIZIONE Description	± mm	FORMATI Sizes	SCATOLA_Box				PALLET		
				KG	M <sup>2</sup>	ML		KG	M <sup>2</sup>
FONDO NATURALE	10,5	30x180 RECT	2	25,5	1,08	-	36	918	38,88
FONDO NATURALE	10,5	20x180 RECT	3	25,5	1,08	-	48	1224	51,84
FONDO NATURALE	9,5	20x90,5	6	23,3	1,09	-	48	1117	52,1
BATTISCOPA NATURALE	10	10x60,3	16	20	0,9648	9,648	48	960	46,31
GRADINO PLUS BORDO NATURALE	10,5	34x120x4,5 RECT	2	30,6	0,82	-	12	367,2	9,792
GRADINO PLUS ANGOLARE NATURALE	10,5	34x120x4,5 RECT	1	15,3	0,408	-	24	367,2	9,792



# Nuance

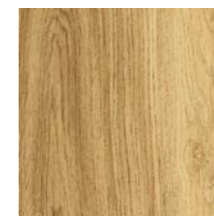

CARAMEL

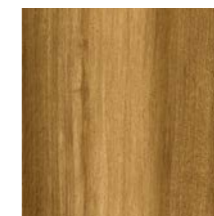

MIEL

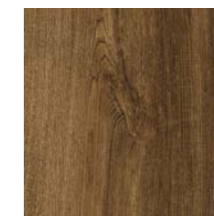

TABAC



CENDRE



PERLE

GRES PORCELLANATO A MASSA COLORATA\_COLOURED-BODY PORCELAIN STONEWARE



± 10,5 mm  
± 9,5 mm



30x180 cm Rect  
12"x71"

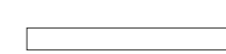

20x180 cm Rect  
8"x71"



30x120 cm Rect  
12"x48"

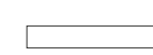

20x120 cm Rect  
8"x48"

GRES PORCELLANATO A MASSA COLORATA\_COLOURED-BODY PORCELAIN STONEWARE **20 mm**



± 20 mm



40x120 cm Rect  
16"x48"



RIVESTIMENTO / WALL Chevron Miel Naturale 55x38 cm Rect - 21<sup>5/8</sup>"x15"  
PAVIMENTO / FLOOR Miel Naturale 20x120 cm Rect - 8"x48"



RIVESTIMENTO / WALL Décoratif Perle Naturale 60x60 cm Rect - 24"x24"  
PAVIMENTO / FLOOR Cendre Naturale 30x120 cm Rect - 12"x48"



RIVESTIMENTO / WALL **Eternity 0.3 Breach Grey Lux 120x260 cm Rect - 48"x102"**  
PAVIMENTO / FLOOR **Caramel Naturale 30x180 cm Rect - 12"x71" \_20x180 cm Rect - 8"x71"**



PAVIMENTO / FLOOR Listello Tabac Naturale 7x60 cm Rect - 2<sup>3</sup>/<sub>4</sub>"x24" \_ Quadrato Tabac Naturale 7x7 cm Rect - 2<sup>3</sup>/<sub>4</sub>"x2<sup>3</sup>/<sub>4</sub>"  
Trilogy Calacatta White Lux 60x60 cm Rect - 24"x24"



PAVIMENTO / FLOOR Chevron Cendre Naturale 55x38 cm Rect - 21<sup>5</sup>/<sub>8</sub>"x15"



PAVIMENTO / FLOOR Tabac Naturale 20x120 cm Rect - 8"x48" \_Tabac Strutturato 20x120 cm Rect - 8"x48"

# Nuance

**PR( )TECT**  
ANTIBATTERICO - ANTIMICROBIAL

CARAMEL



MIEL



TABAC



CENDRE



PERLE



# Nuance

**GRES PORCELLANATO A MASSA COLORATA**\_COLOURED-BODY PORCELAIN STONEWARE

± 10,5 mm

30x180 cm Rect - 12"x71"

Caramel NATURALE PGIN1001  
Miel NATURALE PGIN1201  
Tabac NATURALE PGIN1401  
Cendre NATURALE PGIN1101  
Perle NATURALE PGIN1301

± 10,5 mm

20x180 cm Rect - 8"x71"

Caramel NATURALE PG4N100G  
Miel NATURALE PG4N120G  
Tabac NATURALE PG4N140G  
Cendre NATURALE PG4N110G  
Perle NATURALE PG4N130G

± 9,5 mm

30x120 cm Rect - 12"x48"

Caramel NATURALE PG6N100  
Miel NATURALE PG6N120  
Tabac NATURALE PG6N140  
Cendre NATURALE PG6N110  
Perle NATURALE PG6N130

± 9,5 mm

20x120 cm Rect - 8"x48"

Caramel NATURALE PGON100  
Miel NATURALE PGON120  
Tabac NATURALE PGON140  
Cendre NATURALE PGON110  
Perle NATURALE PGON130  
Caramel STRUTTURATO\* PGON105  
Miel STRUTTURATO\* PGON125  
Tabac STRUTTURATO\* PGON145  
Cendre STRUTTURATO\* PGON115  
Perle STRUTTURATO\* PGON135

**GRES PORCELLANATO A MASSA COLORATA**\_COLOURED-BODY PORCELAIN STONEWARE **20 mm**

± 20 mm

40x120 cm Rect - 16"x48"

Caramel STRUTTURATO\* PG9N1001  
Miel STRUTTURATO\* PG9N1201  
Tabac STRUTTURATO\* PG9N1401

## DECORI\_DECORS

**GRES A MASSA COLORATA**\_COLOURED-BODY STONEWARE

CARAMEL



DÉCORATIF NATURALE  
60x60 cm Rect - 24"x24"  
± 9,5 mm

PGWN100

MIEL

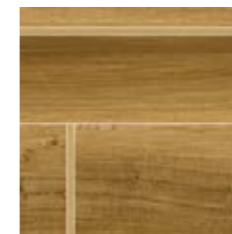

DÉCORATIF NATURALE  
60x60 cm Rect - 24"x24"  
± 9,5 mm

PGWN120

TABAC



DÉCORATIF NATURALE  
60x60 cm Rect - 24"x24"  
± 9,5 mm

PGWN140

CENDRE



DÉCORATIF NATURALE  
60x60 cm Rect - 24"x24"  
± 9,5 mm

PGWN110

PERLE



DÉCORATIF NATURALE  
60x60 cm Rect - 24"x24"  
± 9,5 mm

PGWN130



CHEVRON NATURALE  
55x38 cm Rect - 21<sup>5/8</sup>"x15"  
± 9,5 mm

PGZN110



CHEVRON NATURALE  
55x38 cm Rect - 21<sup>5/8</sup>"x15"  
± 9,5 mm

PGZN112



CHEVRON NATURALE  
55x38 cm Rect - 21<sup>5/8</sup>"x15"  
± 9,5 mm

PGZN114



CHEVRON NATURALE  
55x38 cm Rect - 21<sup>5/8</sup>"x15"  
± 9,5 mm

PGZN111



CHEVRON NATURALE  
55x38 cm Rect - 21<sup>5/8</sup>"x15"  
± 9,5 mm

PGZN113

DÉCORATIF:

Posare solo a parete\_Recommended only for wall applications\_Nur an der Wand verlegen\_Recommandé seulement pour les revêtements

\* Protezione antibatterica non presente\_No antimicrobial protection\_Der Antibakterielle Schutz nicht vorhanden\_Protection antibactérienne pas présente

DESTINAZIONI D'USO\_INTENDED USE: NATURALE STRUTTURATO

DATI TECNICI\_TECHNICAL DATA:

GRES PORCELLANATO A MASSA COLORATA COLOURED-BODY PORCELAIN STONEWARE		GRES PORCELLANATO A MASSA COLORATA COLOURED-BODY PORCELAIN STONEWARE	
±	10,5 / 9,5 mm	±	20 mm
DIN 51130:	R10 Naturale R11 Strutturato	DIN 51130:	R11 Strutturato
DIN 51097:	C (A+B+C) Strutturato	DIN 51097:	C (A+B+C) Strutturato
BCR TORTUS:	μ > 0,40 Naturale - Strutturato	BCR TORTUS:	μ > 0,40 Strutturato
ANSI A326.3:	DCOF ≥ 0,42 Naturale - Strutturato	ANSI A326.3:	DCOF ≥ 0,42 Strutturato
AS/NZS 4586:	P4 Strutturato	AS/NZS 4586:	P4 Strutturato
BS 7976-2:	PTV 36+WET (SI.96 - SI.55) Strutturato	BS 7976-2:	PTV 36+WET (SI.96 - SI.55) Strutturato
	ANSI A137.1: V3 Naturale - Strutturato		ANSI A137.1: V3 Strutturato

**PR( )TECT**  
ANTIBATTERICO - ANTIMICROBIAL Naturale



# Nuance

## DECORI\_DECORS

GRES PORCELLANATO A MASSA COLORATA\_COLOURED-BODY PORCELAIN STONWARE

### CARAMEL



MOSAIQUE NATURALE  
30x30 cm Rect - 12"x12"  
± 9,5 mm  
PGZN120

### MIEL



MOSAIQUE NATURALE  
30x30 cm Rect - 12"x12"  
± 9,5 mm  
PGZN122

### TABAC



MOSAIQUE NATURALE  
30x30 cm Rect - 12"x12"  
± 9,5 mm  
PGZN124

### CENDRE



MOSAIQUE NATURALE  
30x30 cm Rect - 12"x12"  
± 9,5 mm  
PGZN121

### PERLE



MOSAIQUE NATURALE  
30x30 cm Rect - 12"x12"  
± 9,5 mm  
PGZN123



LISTELLO NATURALE  
7x60 cm Rect - 2<sup>3/4</sup>"x24"  
± 9,5 mm  
PGZN1L0



LISTELLO NATURALE  
7x60 cm Rect - 2<sup>3/4</sup>"x24"  
± 9,5 mm  
PGZN1L2



LISTELLO NATURALE  
7x60 cm Rect - 2<sup>3/4</sup>"x24"  
± 9,5 mm  
PGZN1L4



LISTELLO NATURALE  
7x60 cm Rect - 2<sup>3/4</sup>"x24"  
± 9,5 mm  
PGZN1L1



LISTELLO NATURALE  
7x60 cm Rect - 2<sup>3/4</sup>"x24"  
± 9,5 mm  
PGZN1L3



QUADRATO NATURALE  
7x7 cm Rect - 2<sup>3/4</sup>"x2<sup>3/4</sup>"  
± 9,5 mm  
PGZN100



QUADRATO NATURALE  
7x7 cm Rect - 2<sup>3/4</sup>"x2<sup>3/4</sup>"  
± 9,5 mm  
PGZN102



QUADRATO NATURALE  
7x7 cm Rect - 2<sup>3/4</sup>"x2<sup>3/4</sup>"  
± 9,5 mm  
PGZN104



QUADRATO NATURALE  
7x7 cm Rect - 2<sup>3/4</sup>"x2<sup>3/4</sup>"  
± 9,5 mm  
PGZN101



QUADRATO NATURALE  
7x7 cm Rect - 2<sup>3/4</sup>"x2<sup>3/4</sup>"  
± 9,5 mm  
PGZN103

## ESEMPI COMPOSIZIONI\_TILE LAYOUT EXAMPLES



NUANCE LISTELLO Tabac Naturale  
NUANCE QUADRATO Tabac Naturale  
TRILOGY Calacatta White Lux 60x60 cm Rect



NUANCE LISTELLO Perle Naturale  
NUANCE QUADRATO Cendre Naturale  
TRILOGY Calacatta White Lux 60x60 cm Rect



NUANCE LISTELLO Cendre Naturale  
NUANCE QUADRATO Perle Naturale  
TRILOGY Calacatta White Lux 60x60 cm Rect

Per questo tipo di posa Listello e Quadrato Nuance sono abbinabili tra loro e con tutti i fondi 60x60 rettificati delle collezioni a catalogo. For this laying solution Nuance Listello and Quadrato are matchable with the 60x60 rectified of all collections. Bei dieser Art von Verlegung sind Listello und Quadrato Nuance untereinander und mit allen begradtigten 60x60 Untergrunden der Katalogkollektionen kombinierbar. Pour ce type de pose Listello et Quadrato Nuance sont combinables entre eux et avec tous les fonds de 60x60 rectifiés des collections du catalogue.

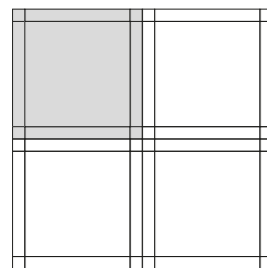

Modulo A\_Modulo A\_Modulo A\_Modulo A

4 PEZZI 7x60 (30,68%)  
4 PEZZI 7x7 (3,58%)  
1 PEZZO 60x60 (80,20%)

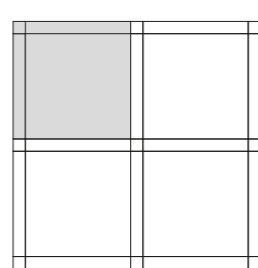

Modulo B\_Modulo B\_Modulo B\_Modulo B

2 PEZZI 7x60 (18,71%)  
1 PEZZI 7x7 (1,09%)  
1 PEZZO 60x60 (80,20%)

# Nuance

## PEZZI SPECIALI\_TRIM PIECES

GRES PORCELLANATO A MASSA COLORATA\_COLOURED-BODY PORCELAIN STONWARE

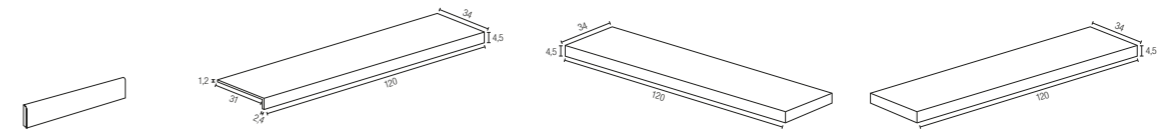

BATTISCOPIA  
7,5x60 cm - 3"x24"  
± 10 mm  
NATURALE

GRADINO PLUS BORDO  
34x120x4,5 cm Rect - 13<sup>3/8</sup>"x48"x1<sup>3/4</sup>"  
± 9,5 mm  
NATURALE

GRADINO PLUS ANGOLARE DX  
34x120x4,5 cm Rect - 13<sup>3/8</sup>"x48"x1<sup>3/4</sup>"  
± 9,5 mm  
NATURALE

GRADINO PLUS ANGOLARE SX  
34x120x4,5 cm Rect - 13<sup>3/8</sup>"x48"x1<sup>3/4</sup>"  
± 9,5 mm  
NATURALE

CARAMEL	PGRN150	PGDN100	PGDN101	PGDN102
MIEL	PGRN170	PGDN120	PGDN121	PGDN122
TABAC	PGRN190	PGDN140	PGDN141	PGDN142
CENDRE	PGRN160	PGDN110	PGDN111	PGDN112
PERLE	PGRN180	PGDN130	PGDN131	PGDN132

GRES PORCELLANATO A MASSA COLORATA\_COLOURED-BODY PORCELAIN STONWARE 20 mm

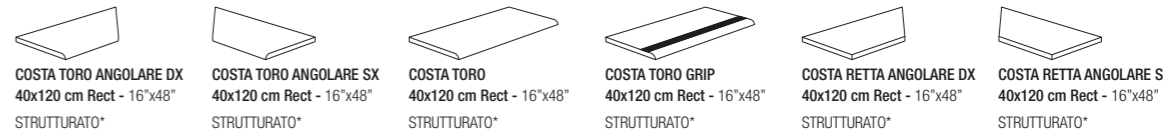

COSTA TORO ANGOLARE DX  
40x120 cm Rect - 16"x48"  
STRUTTURATO\*

COSTA TORO ANGOLARE SX  
40x120 cm Rect - 16"x48"  
STRUTTURATO\*

COSTA TORO  
40x120 cm Rect - 16"x48"  
STRUTTURATO\*

COSTA TORO GRIP  
40x120 cm Rect - 16"x48"  
STRUTTURATO\*

COSTA RETTA ANGOLARE DX  
40x120 cm Rect - 16"x48"  
STRUTTURATO\*

COSTA RETTA ANGOLARE SX  
40x120 cm Rect - 16"x48"  
STRUTTURATO\*

CARAMEL	PGDN1K3	PGDN1K0	PGDN1F0	PGDN1J0	PGDN1D3	PGDN1D0
MIEL	PGDN1K4	PGDN1K1	PGDN1F2	PGDN1J2	PGDN1D4	PGDN1D1
TABAC	PGDN1K5	PGDN1K2	PGDN1F4	PGDN1J4	PGDN1D5	PGDN1D2



COSTA RETTA  
40x120 cm Rect - 16"x48"  
STRUTTURATO\*



COSTA RETTA GRIP  
40x120 cm Rect - 16"x48"  
STRUTTURATO\*



GRIGLIA ANGOLARE DX  
15x60 cm Rect - 6"x24"  
STRUTTURATO\*



GRIGLIA ANGOLARE SX  
15x60 cm Rect - 6"x24"  
STRUTTURATO\*



GRIGLIA  
15x60 cm Rect - 6"x24"  
STRUTTURATO\*

CARAMEL	PGDN1C0	PGDN1G0	PGDN1A3	PGDN1A0	PGDN1Z0
MIEL	PGDN1C2	PGDN1G2	PGDN1A4	PGDN1A1	PGDN1Z2
TABAC	PGDN1C4	PGDN1G4	PGDN1A5	PGDN1A2	PGDN1Z4

\* Protezione antibatterica non presente\_No antimicrobial protection\_Der Antibakterielle Schutz nicht vorhanden\_Protection antibactérienne pas présente

## IMBALLAGGI E PESI\_PACKINGS AND WEIGHTS

DESCRIZIONE Description	± mm	FORMATI Sizes	SCATOLA_Box				PALLET		
			📦	📊	📏	📏	📦	📊	📏
FONDO NATURALE / STRUTTURATO	9,5	20x120 RECT	5	26,3	1,2	-	24	631,2	28,8
FONDO NATURALE	9,5	30x120 RECT	4	30,4	1,44	-	18	547,2	25,92
FONDO NATURALE	10,5	20x180 RECT	3	25,5	1,08	-	48	1224	51,84
FONDO NATURALE	10,5	30x180 RECT	2	25,5	1,08	-	36	918	38,88
DÉCORATIF NATURALE	9,5	60x60 RECT	2	15,9	0,72	-	30	477	21,6
CHEVRON NATURALE	9,5	55x38 RECT	4	17,1	0,836	-	24	410,4	20,06
MOSAIQUE NATURALE	9,5	30x30 RECT	6	11,1	0,54	-	42	466,83	22,68
LISTELLO NATURALE	9,5	7x60 RECT	16	13,77	0,672	-	40	551	26,88
QUADRATO NATURALE	9,5	7x7 RECT	16	1,6	0,08	-	456	736	35,8
GRADINO PLUS BORDO NATURALE	9,5	34x120x4,5 RECT	2	33,25	0,816	-	12	399	9,8
GRADINO PLUS ANGOLARE NATURALE	9,5	34x120x4,5 RECT	1	16,62	0,408	-	24	399	9,79
BATTISCOPIA NATURALE	10	7,5x60 RECT	12	11,61	0,54	7,2	60	696,6	32,4
FONDO STRUTTURATO	20	40x120 RECT	2	46	0,96	-	20	920	19,2
COSTA TORO STRUTTURATO	20	40x120 RECT	1	23	0,48	-	-	-	-
COSTA TORO ANGOLARE STRUTTURATO	20	40x120 RECT	1	21	0,4	-	-	-	-
COSTA TORO GRIP STRUTTURATO	20	40x120 RECT	1	23	0,48	-	-	-	-
COSTA RETTA STRUTTURATO	20	40x120 RECT	1	23	0,48	-	-	-	-
COSTA RETTA ANGOLARE STRUTTURATO	20	40x120 RECT	1	21	0,4	-	-	-	-
COSTA RETTA GRIP STRUTTURATO	20	40x120 RECT	1	23	0,48	-	-	-	-
GRIGLIA STRUTTURATO	20	15x60 RECT	2	8	0,18	-	100	800	18
GRIGLIA ANGOLARE STRUTTURATO	20	15x60 RECT	2	7	0,1575	-	100	700	15,75



# Wood Relive

Fiordo



FLORIDA



ALASKA



OREGON



MONTANA

GRES PORCELLANATO SMALTATO \_GLAZED PORCELAIN STONEWARE



± 9,5 mm



20x121,5 cm  
8"x48"



PAVIMENTO / FLOOR Alaska Naturale 20x121,5 cm - 8"x48"



PAVIMENTO / FLOOR Oregon Naturale 20x121,5 cm - 8"x48"



RIVESTIMENTO / WALL Florida Naturale 20x121,5 cm - 8"x48"



PAVIMENTO / FLOOR Florida Naturale 20x121,5 cm - 8"x48"

# Wood Relive

## FLORIDA



## ALASKA



## OREGON



## MONTANA



DESTINAZIONI D'USO\_INTENDED USE: NATURALE   

### DATI TECNICI\_TECHNICAL DATA:

**GRES PORCELLANATO SMALTATO**  
GLAZED PORCELAIN STONEWARE

± 9,5 mm

 DIN 51130: **R10** Naturale  
DIN 51097: **B (A+B)** Naturale  
BCR TORTUS:  $\mu > 0,40$  Naturale  
ANSI A326.3: **DCOF  $\geq 0,42$**  Naturale

 ANSI A137.1: **V2** Naturale (Florida)  
**V3** Naturale (Alaska-Oregon-Montana)

# Wood Relive

## GRES PORCELLANATO SMALTATO\_GLAZED PORCELAIN STONEWARE

± 9,5 mm

20x121,5 cm - 8"x48"

Florida NATURALE FGOWR10  
Alaska NATURALE FGOWR00  
Oregon NATURALE FGOWR30  
Montana NATURALE FGOWR20

## PEZZI SPECIALI\_TRIM PIECES



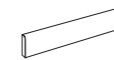



### GRES PORCELLANATO SMALTATO\_GLAZED PORCELAIN STONEWARE



**BATTISCOPIA**  
10x60,4 cm - 4"x24"  
± 10 mm  
NATURALE

FLORIDA **FGRWR10**  
ALASKA **FGRWR00**  
OREGON **FGRWR30**  
MONTANA **FGRWR20**

## IMBALLAGGI E PESI\_PACKINGS AND WEIGHTS

DESCRIZIONE Description	± mm	FORMATI Sizes	SCATOLA_Box				PALLET			
										
FONDO NATURALE	9,5	20x121,5	5	27,3	1,22	-	24	655	29,2	
BATTISCOPIA NATURALE	10	10x60,4	16	20	0,966	9,66	48	960	46,39	



## Effetto cromatico

Chromatic look\_Chromatischer Effekt\_Effet chromatique



# Even

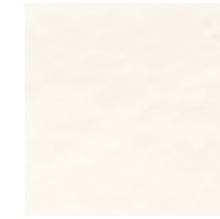

SNOW



IVORY



DOVE



CHERRY



LEAF

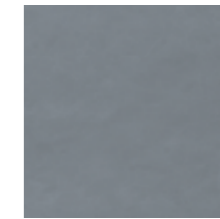

OCEAN

MONOPOROSA IN PASTA BIANCA SMALTATA - GLAZED WHITE BODY POROUS SINGLE-FIRED WALL TILES



± 10,5 mm



35x100 cm Rect  
13<sup>3/4</sup>"x39"

RIVESTIMENTO / WALL Ocean 35x100 cm Rect - 13<sup>3/4</sup>"x39" Framework 35x100 cm Rect - 13<sup>3/4</sup>"x39"  
PAVIMENTO / FLOOR Nuance Caramel Naturelle 20x120 cm Rect - 8"x48" 30x120 cm Rect - 12"x48"





RIVESTIMENTO / WALL Cherry 35x100 cm Rect - 13<sup>3/4</sup>"x39" \_Geometric Warm 35x35 cm Rect - 13<sup>3/4</sup>"x13<sup>3/4</sup>" \_Shapes Snow 35x100 cm Rect - 13<sup>3/4</sup>"x39"  
PAVIMENTO / FLOOR Context Loft Naturale 60x60 cm Rect - 24"x24"



RIVESTIMENTO / WALL Optical 35x100 cm Rect - 13<sup>3/4</sup>"x39"

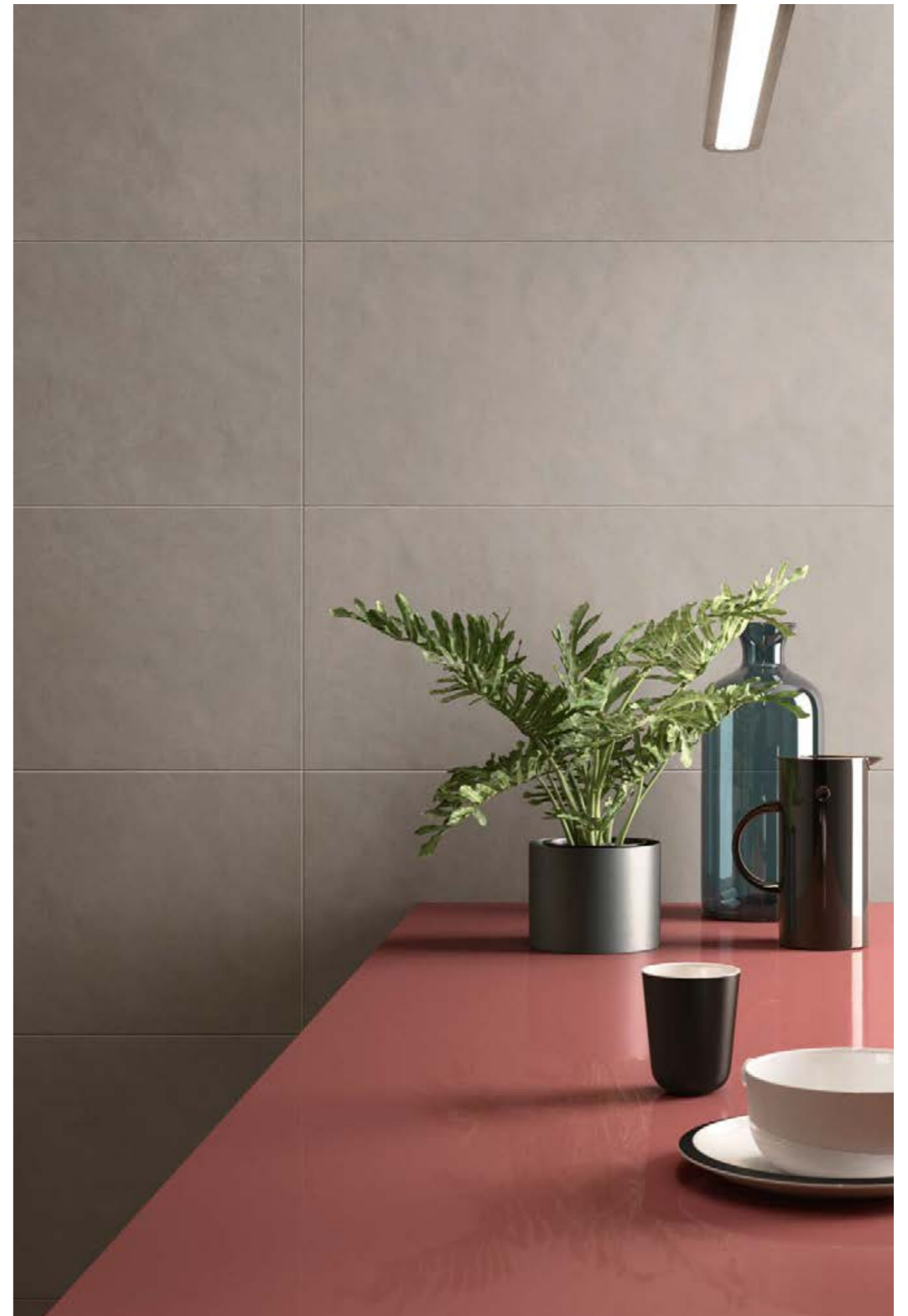

RIVESTIMENTO / WALL Dove 35x100 cm Rect - 13<sup>3/4</sup>"x39"



RIVESTIMENTO / WALL Shapes Snow 35x100 cm Rect - 13<sup>3/4</sup>"x39" \_Medley Cold 35x100 cm Rect - 13<sup>3/4</sup>"x39"



RIVESTIMENTO / WALL Leaf 35x100 cm Rect - 13<sup>3/4</sup>"x39" \_Shapes Ivory 35x100 cm Rect - 13<sup>3/4</sup>"x39"



RIVESTIMENTO / WALL Ocean 35x100 cm Rect - 13<sup>3/4</sup>"x39" \_Shapes Ocean 35x100 cm Rect - 13<sup>3/4</sup>"x39"  
PAVIMENTO / FLOOR Context Hangar Naturale 120x120 cm Rect - 48"x48"

# Even

SNOW



IVORY



DOVE



CHERRY



LEAF



OCEAN

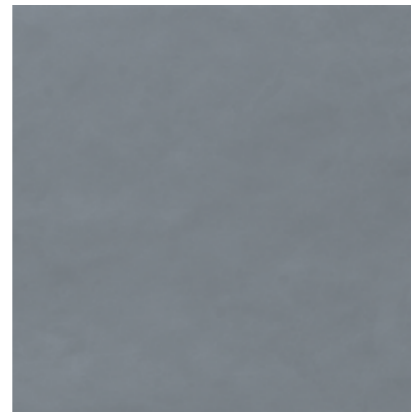

DATI TECNICI / TECHNICAL DATA:

**MONOPOROSA IN PASTA BIANCA SMALTATA**  
GLAZED WHITE BODY POROUS SINGLE-FIRED WALL TILES

± 10,5 mm

ANSI A137.1: V1

# Even

MONOPOROSA IN PASTA BIANCA SMALTATA / GLAZED WHITE BODY POROUS SINGLE-FIRED WALL TILES

± 10,5 mm

35x100 cm Rect - 13<sup>3/4</sup>"x39"

Snow PBF50  
Ivory PBF20  
Dove PBF10  
Cherry PBF00  
Leaf PBF30  
Ocean PBF40

## DECORI / DECORS

MONOPOROSA IN PASTA BIANCA SMALTATA / GLAZED WHITE BODY POROUS SINGLE-FIRED WALL TILES



**FRAMEWORK**  
35x100 cm Rect - 13<sup>3/4</sup>"x39"  
± 10,5 mm  
PBF50



**OPTICAL**  
35x100 cm Rect - 13<sup>3/4</sup>"x39"  
± 10,5 mm  
PBF50



**MEDLEY COLD**  
35x100 cm Rect - 13<sup>3/4</sup>"x39"  
± 10,5 mm  
PBF50



**MEDLEY WARM**  
35x100 cm Rect - 13<sup>3/4</sup>"x39"  
± 10,5 mm  
PBF50



**MEDLEY MIX**  
35x100 cm Rect - 13<sup>3/4</sup>"x39"  
± 10,5 mm  
PBF50

**MEDLEY:**

Sviluppati su 6 soggetti / Developed on 6 patterns / Entwickelt auf 6 Bilder / Développe sur 6 éléments

**FRAMEWORK:**

Sviluppato su 4 soggetti / Developed on 4 patterns / Entwickelt auf 4 Bilder / Développe sur 4 éléments

**MEDLEY - FRAMEWORK:**

I soggetti all'interno della scatola sono presenti in modo casuale / The six patterns are placed in the box randomly / Die Dekor-Bilder sind zufällig eingepack / Les sujets à l'intérieur de la boîte son présent de façon casuelle

# Even

## DECORI\_DECORS

MONOPOROSA IN PASTA BIANCA SMALTATA\_GLAZED WHITE BODY POROUS SINGLE-FIRED WALL TILES

### SNOW



**SHAPES**  
35x100 cm Rect - 13<sup>3/4</sup>"x39"  
± 10,5 mm  
PBFEVS5



**MOSAICO**  
20x20 cm Rect - 8"x8"  
± 10,5 mm  
PBEEV50

### IVORY



**SHAPES**  
35x100 cm Rect - 13<sup>3/4</sup>"x39"  
± 10,5 mm  
PBFEVS2



**MOSAICO**  
20x20 cm Rect - 8"x8"  
± 10,5 mm  
PBEEV20

### DOVE



**SHAPES**  
35x100 cm Rect - 13<sup>3/4</sup>"x39"  
± 10,5 mm  
PBFEVS1



**MOSAICO**  
20x20 cm Rect - 8"x8"  
± 10,5 mm  
PBEEV10

### CHERRY



**SHAPES**  
35x100 cm Rect - 13<sup>3/4</sup>"x39"  
± 10,5 mm  
PBFEVS0

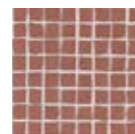

**MOSAICO**  
20x20 cm Rect - 8"x8"  
± 10,5 mm  
PBEEV00

# Even

## DECORI\_DECORS

MONOPOROSA IN PASTA BIANCA SMALTATA\_GLAZED WHITE BODY POROUS SINGLE-FIRED WALL TILES

### LEAF



**SHAPES**  
35x100 cm Rect - 13<sup>3/4</sup>"x39"  
± 10,5 mm  
PBFEVS3

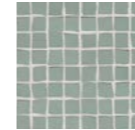

**MOSAICO**  
20x20 cm Rect - 8"x8"  
± 10,5 mm  
PBEEV30

### OCEAN



**SHAPES**  
35x100 cm Rect - 13<sup>3/4</sup>"x39"  
± 10,5 mm  
PBFEVS4

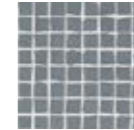

**MOSAICO**  
20x20 cm Rect - 8"x8"  
± 10,5 mm  
PBEEV40



**GEOMETRIC WARM**  
35x35 cm Rect - 13<sup>3/4</sup>"x13<sup>3/4</sup>"  
± 10,5 mm  
PBCEVG1



**GEOMETRIC COLD**  
35x35 cm Rect - 13<sup>3/4</sup>"x13<sup>3/4</sup>"  
± 10,5 mm  
PBCEVG0

## IMBALLAGGI E PESI\_PACKINGS AND WEIGHTS

DESCRIZIONE Description	± mm	FORMATI Sizes	SCATOLA_Box				PALLET		
FONDO	10,5	35x100 <sup>RECT</sup>	3	20,15	1,05	-	28	564,2	29,4
SHAPES	10,5	35x100 <sup>RECT</sup>	3	20,15	1,05	-	26	523,9	27,3
MEDLEY COLD	10,5	35x100 <sup>RECT</sup>	3	20,15	1,05	-	28	564,2	29,4
MEDLEY WARM	10,5	35x100 <sup>RECT</sup>	3	20,15	1,05	-	28	564,2	29,4
MEDLEY MIX	10,5	35x100 <sup>RECT</sup>	3	20,15	1,05	-	28	564,2	29,4
FRAMEWORK	10,5	35x100 <sup>RECT</sup>	3	20,15	1,05	-	28	564,2	29,4
OPTICAL	10,5	35x100 <sup>RECT</sup>	3	19,8	1,05	-	12	237,6	12,6
GEOMETRIC COLD	10,5	35x35 <sup>RECT</sup>	4	12,4	0,49	-	60	744	29,4
GEOMETRIC WARM	10,5	35x35 <sup>RECT</sup>	4	12,4	0,49	-	60	744	29,4
MOSAICO	10,5	20x20 <sup>RECT</sup>	9	4,837	0,36	-	90	435,37	32,4



RIVESTIMENTO / WALL - Mistic 50x100 cm Rect - 19 1/2" x 39"

# Glam

GRES PORCELLANATO LAMINATO  
LAMINATED PORCELAIN STONEWARE **Zero.3**



RIVESTIMENTI DECORATI DA INTERNO  
INTERIOR DECORATED WALL COVERINGS

± 3,5 mm

50x100 cm Rect - 19 1/2" x 39"



MISTIC A+B

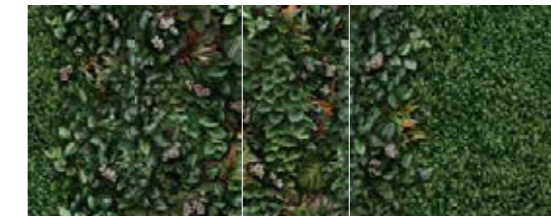

GREENWALL A+B+C+D+E



RAINFOREST A+B



COLORFUL A+B+C+D+E



HEDGE A+B



RELIC A+B



TARTAN MAUVE



TARTAN BEIGE



BOISERIE MAUVE



BOISERIE BEIGE



SHAPES A+B+C+D+E



WASHI



REFLEX A+B+C+D+E

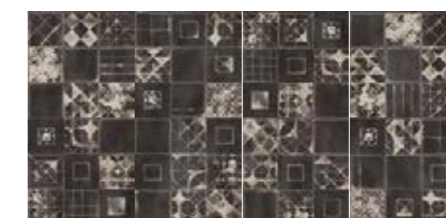

VIBES A+B+C+D



RIVESTIMENTO / WALL Greenwall 50x100 cm Rect - 19 1/2"x39"  
PAVIMENTO / FLOOR Tracks Soil Naturale 60x60 cm Rect - 24"x24"





RIVESTIMENTO / WALL Rainforest 50x100 cm Rect - 19 1/2"x39"



RIVESTIMENTO / WALL Colorful 50x100 cm Rect - 19 1/2"x39"  
PAVIMENTO / FLOOR Borealis Inari Naturale 20x120 cm Rect - 8"x48"



RIVESTIMENTO / WALL Hedge 50x100 cm Rect - 19<sup>1</sup>/<sub>2</sub>"x39"  
PAVIMENTO / FLOOR Motion Mid Naturale 60x60 cm Rect - 24"x24"



RIVESTIMENTO / WALL Relic 50x100 cm Rect - 19<sup>1</sup>/<sub>2</sub>"x39"  
PAVIMENTO / FLOOR Context Hangar Naturale 120x120 cm Rect - 48"x48"



RIVESTIMENTO / WALL Boiserie Mauve 50x100 cm Rect - 19<sup>1</sup>/<sub>2</sub>"x39" \_ Tartan Mauve 50x100 cm Rect - 19<sup>1</sup>/<sub>2</sub>"x39"  
PAVIMENTO / FLOOR Frame Glen Naturale 60x60 cm Rect - 24"x24"



RIVESTIMENTO / WALL Washi 50x100 cm Rect - 19 1/2"x39"

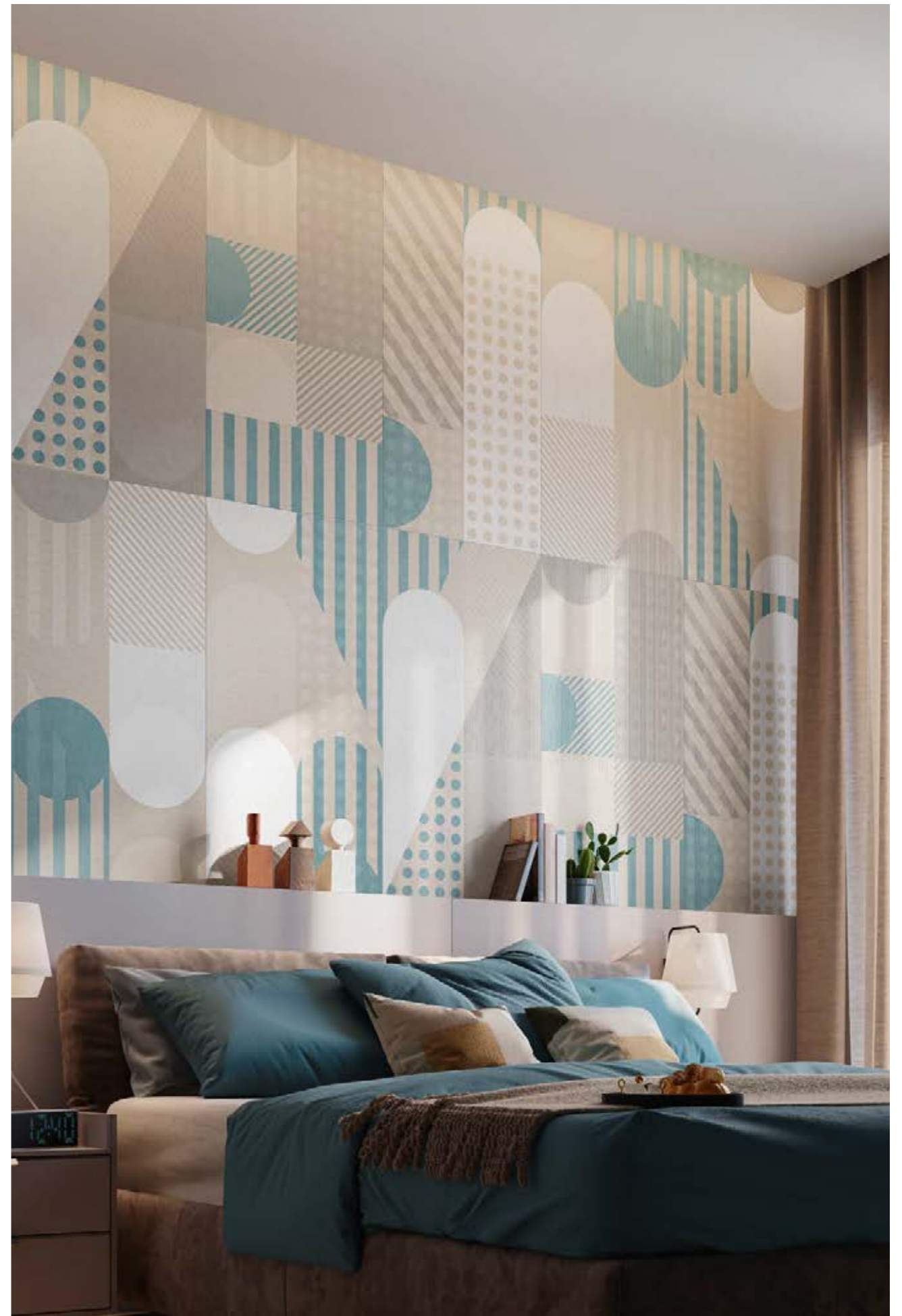

RIVESTIMENTO / WALL Shapes 50x100 cm Rect - 19 1/2"x39"



RIVESTIMENTO / WALL Reflex 50x100 cm Rect - 19 1/2"x39"  
PAVIMENTO / FLOOR Context Loft Naturale 60x60 cm Rect - 24"x24"

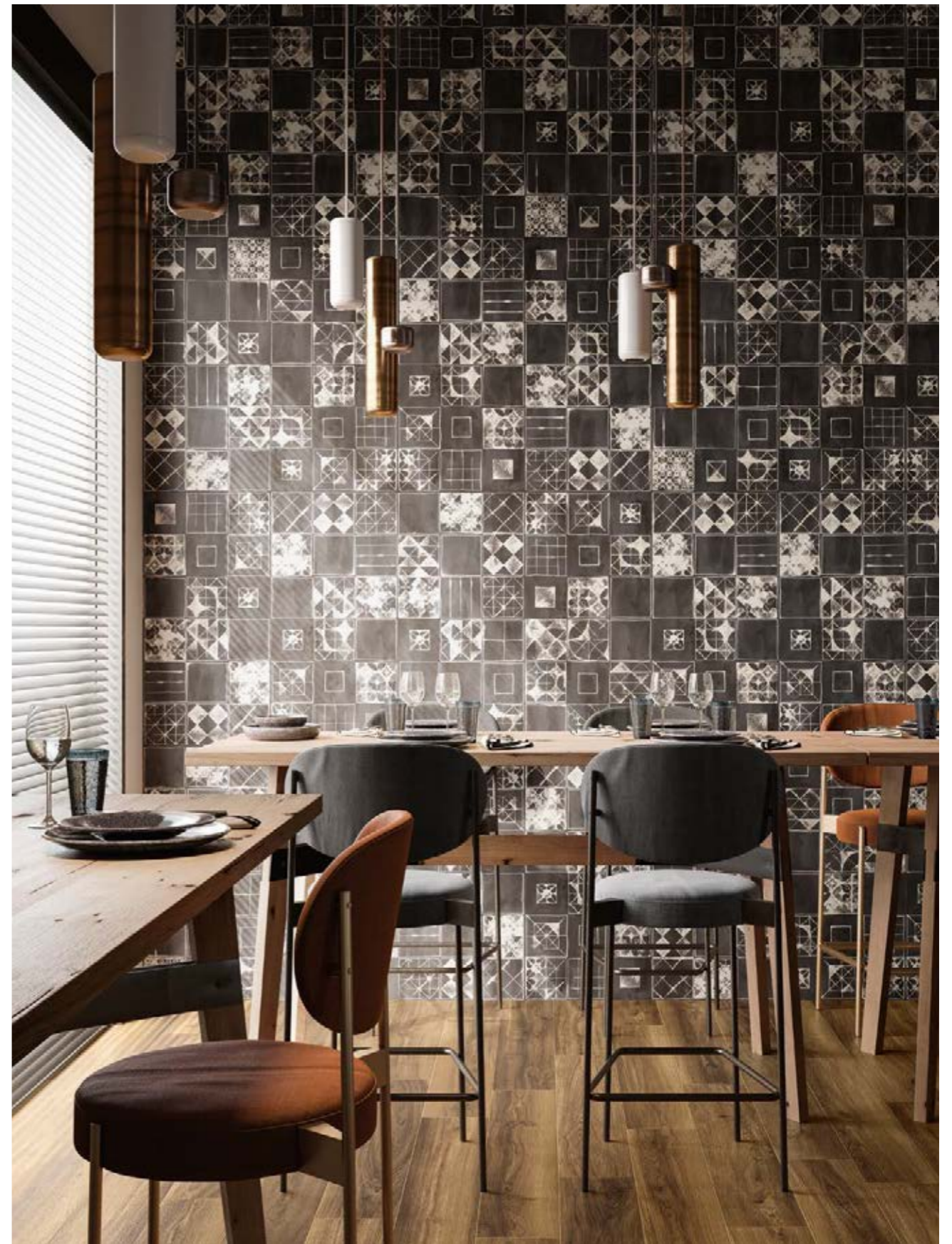

RIVESTIMENTO / WALL Vibes 50x100 cm Rect - 19 1/2"x39"  
PAVIMENTO / FLOOR Nuance Tabac Naturale 20x120 cm Rect - 8"x48"

# Glam

## Natural Mood

### MISTIC



2 moduli\_2 modules\_A+B

### RAINFOREST



2 moduli\_2 modules\_A+B

### HEDGE



2 moduli\_2 modules\_A+B

### GREENWALL



5 moduli\_5 modules\_A+B+C+D+E

### COLORFUL



5 moduli\_5 modules\_A+B+C+D+E

# Glam

## Geometric Mood

### RELIC



2 moduli\_2 modules\_A+B

### TARTAN MAUVE



1 modulo\_1 module\_A

### TARTAN BEIGE



1 modulo\_1 module\_A

### BOISERIE MAUVE



1 modulo\_1 module\_A

### BOISERIE BEIGE



1 modulo\_1 module\_A

### SHAPES



5 moduli\_5 modules\_A+B+C+D+E

### WASHI



1 modulo\_1 module\_A

# Glam

Materic Mood

## REFLEX



5 moduli\_5 modules\_A+B+C+D+E

## VIBES

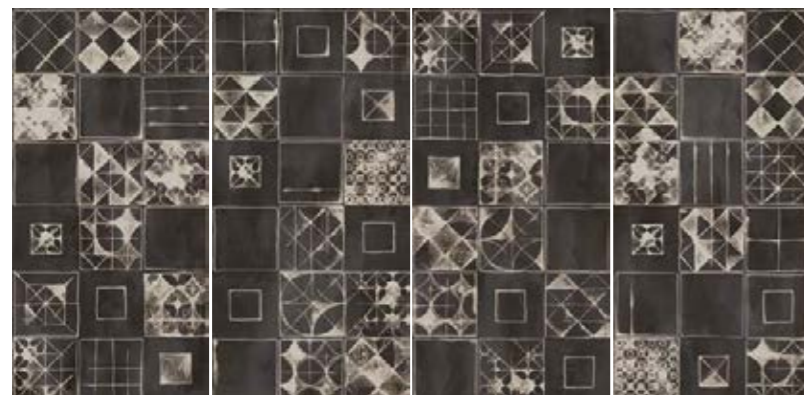

4 moduli\_4 modules\_A+B+C+D

# Glam

## GRES PORCELLANATO LAMINATO\_LAMINATED PORCELAIN STONEWARE **Zero.3**



RIVESTIMENTI DECORATI DA INTERNO  
INTERIOR DECORATED WALL COVERINGS

50x100 cm Rect - 19 1/2"x39"		50x100 cm Rect - 19 1/2"x39"		50x100 cm Rect - 19 1/2"x39"		50x100 cm Rect - 19 1/2"x39"	
Mistic A+B	PG9GM30	Colorful A	PG9GM4A	Relic A+B	PG9GM70	Reflex A	PG9GM8A
Rainforest A+B	PG9GM60	Colorful B	PG9GM4B	Tartan Mauve A	PG9GM50	Reflex B	PG9GM8B
Hedge A+B	PG9GM00	Colorful C	PG9GM4C	Tartan Beige A	PG9GM55	Reflex C	PG9GM8C
Greenwall A	PG9GM9A	Colorful D	PG9GM4D	Boiserie Mauve A	PG9GM10	Reflex D	PG9GM8D
Greenwall B	PG9GM9B	Colorful E	PG9GM4E	Boiserie Beige A	PG9GM20	Reflex E	PG9GM8E
Greenwall C	PG9GM9C			Shapes A	PG9GM6A	Vibes A	PG9GM3A
Greenwall D	PG9GM9D			Shapes B	PG9GM6B	Vibes B	PG9GM3B
Greenwall E	PG9GM9E			Shapes C	PG9GM6C	Vibes C	PG9GM3C
				Shapes D	PG9GM6D	Vibes D	PG9GM3D
				Shapes E	PG9GM6E		
				Washi A	PG9GM40		

MISTIC - RAINFOREST - HEDGE - RELIC:  
2 soggetti per scatola\_2 patterns per box\_2 Bilder  
im Schachtel\_2 motifs par boîte

### DATI TECNICI\_TECHNICAL DATA:

GRES PORCELLANATO LAMINATO  
LAMINATED PORCELAIN STONEWARE

± 3,5 mm

ANSI A137.1: V0

Le lastre della collezione Glam sono decorate mediante la tecnologia di stampa digitale a freddo, che permette di raggiungere risultati estetici e cromatici di eccezionale qualità. Le grafiche vengono impresse ad altissima risoluzione sul supporto ceramico, mantenendo invariati i colori brillanti e le sfumature dei motivi decorativi.

The slabs of the Glam collection are decorated using digital cold printing technology, with which aesthetic, chromatic results of exceptional quality are achieved. The graphics are imprinted at very high resolution on the ceramic substrate, keeping the brilliant colors and shades of the decorative designs unchanged.

Die Platten der Kollektion Glam werden nach dem Brennen im Digitaldruckverfahren dekoriert, mit dem sich optisch und farblich Ergebnisse von höchster Qualität erzielen lassen. Die Motive werden mit extrem hoher Auflösung auf die Keramikfliese gedruckt, wobei die Leuchtkraft der Farben und die Nuancen der Motive perfekt erhalten bleiben.

Les dalles de la collection Glam sont décorées grâce à la technologie d'impression numérique à froid, qui permet d'obtenir des résultats esthétiques et chromatiques d'une qualité exceptionnelle. Les graphismes sont imprimés en haute résolution sur le support céramique, en préservant la brillance des couleurs et les nuances des motifs décoratifs.

Attention: per la pulizia dei decori attenersi scrupolosamente alle istruzioni riportate a pagina 413. Notice: for decors cleaning you should follow carefully the instructions provided on page 413.

Achtung: für die Reinigung sich genau auf die Anleitungen auf der Seite 413 halten. Attention: pour le nettoyage des décors il faut suivre scrupuleusement les renseignements contenus à page 413.

## IMBALLAGGI E PESI\_PACKINGS AND WEIGHTS

DESCRIZIONE Description	± mm	FORMATI Sizes	SCATOLA_Box				PALLET		
FONDO	3,5	50x100 RECT	2	7,8	1	-	64 pz	249,6	32



# Must

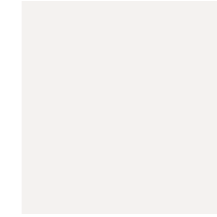

BE WHITE



BE BLACK

GRES PORCELLANATO LAMINATO / LAMINATED PORCELAIN STONEWARE **Zero.3**



± 5,5 mm



100x300 cm Rect  
39"x118"



100x100 cm Rect  
39"x39"





RIVESTIMENTO / WALL Be White Soft 100x300 cm Rect - 39"x118"  
PAVIMENTO / FLOOR Be White Lux 100x100 cm Rect - 39"x39"



PAVIMENTO / FLOOR Be White Lux 100x100 cm Rect - 39"x39"

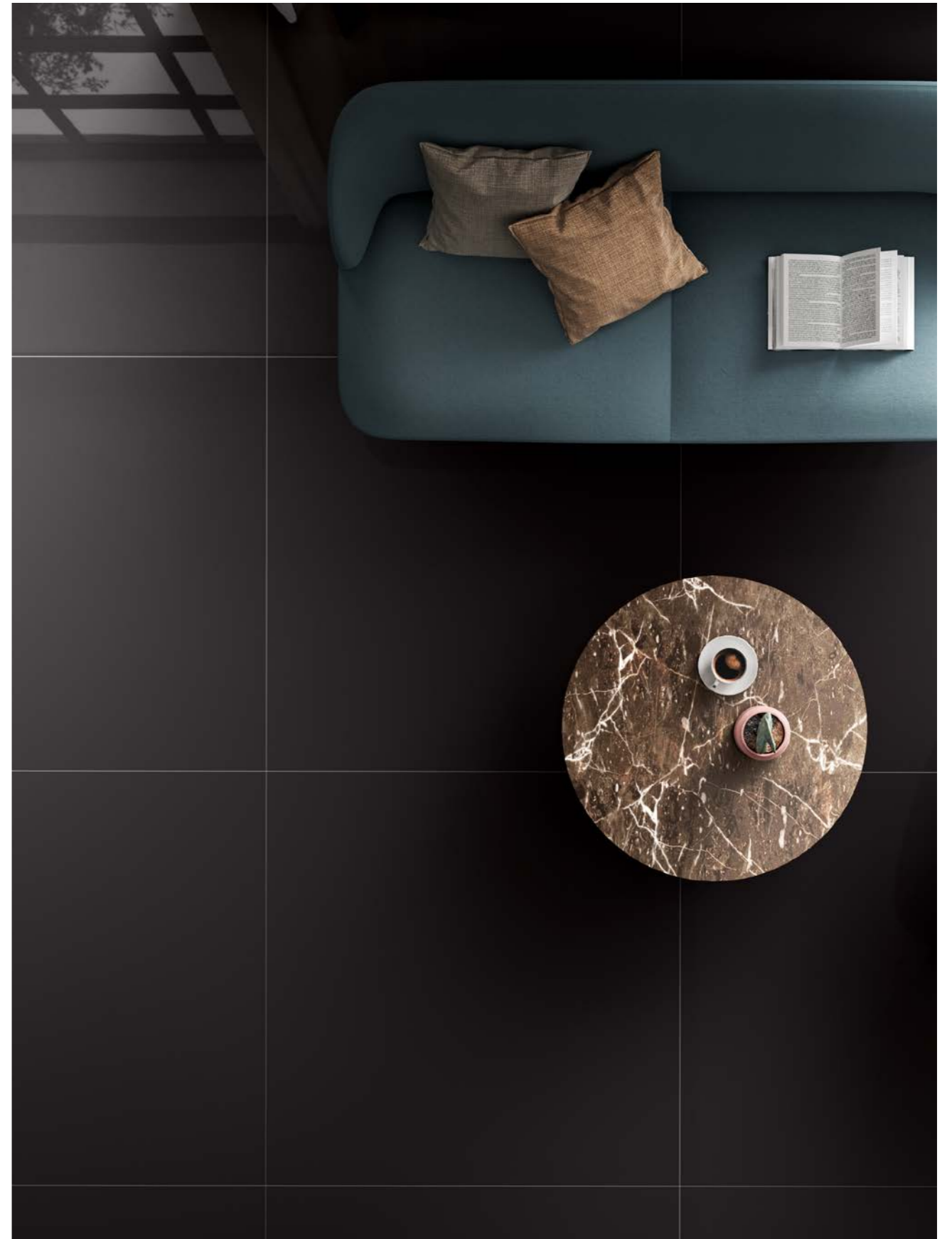

PAVIMENTO / FLOOR Be Black Lux 100x100 cm Rect - 39"x39"



RIVESTIMENTO / WALL Be Black Soft 100x300 cm Rect - 39"x118"  
PAVIMENTO / FLOOR Be Black Lux 100x100 cm Rect - 39"x39"

# Must

**PR( )TECT**  
ANTIBATTERICO - ANTIMICROBIAL

BE WHITE

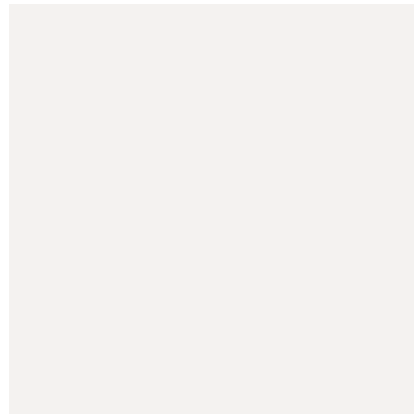

BE BLACK

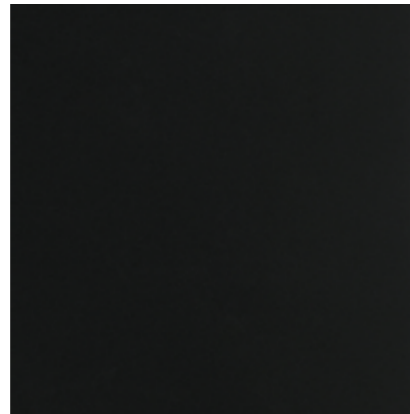

# Must

GRES PORCELLANATO LAMINATO / LAMINATED PORCELAIN STONEWARE **Zero.3**



100x300 cm Rect - 39"x118"

Be White SOFT PZ7MT10  
Be Black SOFT PZ7MT00  
Be White LUX PZ7MTX1  
Be Black LUX PZ7MTX0

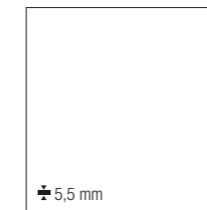

100x100 cm Rect - 39"x39"

Be White SOFT PZ8MT10  
Be Black SOFT PZ8MT00  
Be White LUX PZ8MTX1  
Be Black LUX PZ8MTX0

DESTINAZIONI D'USO / INTENDED USE: SOFT LUX \*solo Be White\_only Be White

DATI TECNICI / TECHNICAL DATA:

<b>GRES PORCELLANATO LAMINATO</b> LAMINATED PORCELAIN STONEWARE	
5,5 mm	
ANSI A326.3: DCOF ≥ 0.42 Soft	
ANSI A137.3: V1 Soft - Lux	
<b>PR( )TECT</b> ANTIBATTERICO - ANTIMICROBIAL Soft - Lux	

## IMBALLAGGI E PESI / PACKINGS AND WEIGHTS

DESCRIZIONE Description	mm	FORMATI Sizes	SCATOLA / Box				PALLET		
FONDO SOFT / LUX	5,5	100x300 RECT	1	34,5	3	-	13	448,5	39
FONDO SOFT / LUX	5,5	100x100 RECT	2	23	2	-	25	575	50



# Wallcraft



WAX



VANILLA



GEM



TAN



SPRING



MINT



WAVE

MONOPOROSA IN PASTA BIANCA SMALTATA\_GLAZED WHITE BODY POROUS SINGLE-FIRED WALL TILES



± 10,5 mm



35x100 cm Rect  
13<sup>3/4</sup>"x39"

RIVESTIMENTO / WALL Wave 35x100 cm Rect - 13<sup>3/4</sup>"x39"  
PAVIMENTO / FLOOR Opificio 22/a Terra Naturale 90x90 cm Rect - 36"x36"



RIVESTIMENTO / WALL Wave 35x100 cm Rect - 13<sup>3/4</sup>"x39" \_Impulse 35x100 cm Rect - 13<sup>3/4</sup>"x39" \_Enigma Wax 35x100 cm Rect - 13<sup>3/4</sup>"x39"  
PAVIMENTO / FLOOR Context Loft Naturale 90x90 cm Rect - 36"x36"



RIVESTIMENTO / WALL Bloom Cold 35x100 cm Rect - 13<sup>3/4</sup>"x39" \_Tan 35x100 cm Rect - 13<sup>3/4</sup>"x39"  
PAVIMENTO / FLOOR Borealis Alta Naturale 20x120 cm Rect - 8"x48"



RIVESTIMENTO / WALL Gem 35x100 cm Rect - 13<sup>3/4</sup>"x39" \_Enigma Wax 35x100 cm Rect - 13<sup>3/4</sup>"x39"  
PAVIMENTO / FLOOR Borealis Donegal Naturale 30x180 cm Rect - 12"x71"



RIVESTIMENTO / WALL Mint 35x100 cm Rect - 13<sup>3/4</sup>"x39" \_Gallery 35x100 cm Rect - 13<sup>3/4</sup>"x39"  
 PAVIMENTO / FLOOR Opificio 22/a Calce Naturale 60x60 cm Rect - 24"x24"



RIVESTIMENTO / WALL Bloom Warm 35x100 cm Rect - 13<sup>3/4</sup>"x39"  
 PAVIMENTO / FLOOR Opificio 22/a Argilla Naturale 60x60 cm Rect - 24"x24"





RIVESTIMENTO / WALL Vanilla 35x100 cm Rect - 13<sup>3/4</sup>"x39" \_Spring 35x100 cm Rect - 13<sup>3/4</sup>"x39"

# Wallcraft

WAX



VANILLA



GEM



TAN



SPRING



MINT



WAVE

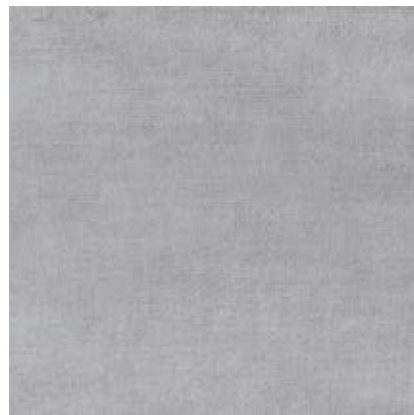

DATI TECNICI / TECHNICAL DATA:

**MONOPOROSA IN PASTA BIANCA SMALTATA**  
GLAZED WHITE BODY POROUS SINGLE-FIRED WALL TILES

✚ 10,5 mm

ANSI A137.1: V1

# Wallcraft

MONOPOROSA IN PASTA BIANCA SMALTATA / GLAZED WHITE BODY POROUS SINGLE-FIRED WALL TILES

✚ 10,5 mm

35x100 cm Rect - 13<sup>3/4</sup>"x39"

Wax PBFWL60  
Vanilla PBFWL40  
Gem PBFWL00  
Tan PBFWL30  
Spring PBFWL20  
Mint PBFWL10  
Wave PBFWL50

## DECORI / DECORS

MONOPOROSA IN PASTA BIANCA SMALTATA / GLAZED WHITE BODY POROUS SINGLE-FIRED WALL TILES



**IMPULSE**  
35x100 cm Rect - 13<sup>3/4</sup>"x39"  
✚ 10,5 mm  
PBFWL10



**GALLERY**  
35x100 cm Rect - 13<sup>3/4</sup>"x39"  
✚ 10,5 mm  
PBFWLGO



**BLOOM COLD**  
35x100 cm Rect - 13<sup>3/4</sup>"x39"  
✚ 10,5 mm  
PBFWLCO



**BLOOM WARM**  
35x100 cm Rect - 13<sup>3/4</sup>"x39"  
✚ 10,5 mm  
PBFWLWO

## DECORI / DECORS

I soggetti all'interno della scatola sono presenti in modo casuale. / The patterns are placed in the box randomly. / Die Dekor-Bilder sind zufällig eingepackt. / Les sujets à l'intérieur de la boîte sont présent de façon casuelle.

### IMPULSE:

Sviluppato su 4 soggetti / Developed on 4 patterns / Entwickelt auf 4 Bilder / Développe sur 4 éléments

### GALLERY:

Sviluppato su 3 soggetti / Developed on 3 patterns / Entwickelt auf 3 Bilder / Développe sur 3 éléments

### BLOOM COLD:

Sviluppato su 4 soggetti / Developed on 4 patterns / Entwickelt auf 4 Bilder / Développe sur 4 éléments

Abbinabile ai colori / Matches with colors / Mit den Farben kombinierbar / À combiner avec les couleurs: **WAX - GEM - TAN**

### BLOOM WARM:

Sviluppato su 4 soggetti / Developed on 4 patterns / Entwickelt auf 4 Bilder / Développe sur 4 éléments

Abbinabile ai colori / Matches with colors / Mit den Farben kombinierbar / À combiner avec les couleurs: **VANILLA - SPRING - WAVE - TAN**

# Wallcraft

## DECORI\_DECORS

MONOPOROSA IN PASTA BIANCA SMALTATA\_GLAZED WHITE BODY POROUS SINGLE-FIRED WALL TILES



**ENIGMA WAX**  
35x100 cm Rect - 13<sup>3/4</sup>"x39"  
± 10,5 mm  
PBFWLE6



**ENIGMA VANILLA**  
35x100 cm Rect - 13<sup>3/4</sup>"x39"  
± 10,5 mm  
PBFWLE4



**ENIGMA SPRING**  
35x100 cm Rect - 13<sup>3/4</sup>"x39"  
± 10,5 mm  
PBFWLE2



**ENIGMA MINT**  
35x100 cm Rect - 13<sup>3/4</sup>"x39"  
± 10,5 mm  
PBFWLE1



**ENIGMA WAVE**  
35x100 cm Rect - 13<sup>3/4</sup>"x39"  
± 10,5 mm  
PBFWLE5

## IMBALLAGGI E PESI\_PACKINGS AND WEIGHTS

DESCRIZIONE Description	± mm	FORMATI Sizes	SCATOLA_Box				PALLET		
FONDO	10,5	35x100 RECT	3	20,15	1,05	-	28	564,2	29,4
ENIGMA	10,5	35x100 RECT	3	20,15	1,05	-	28	564,2	29,4
IMPULSE	10,5	35x100 RECT	3	20,15	1,05	-	28	564,2	29,4
GALLERY	10,5	35x100 RECT	3	20,15	1,05	-	28	564,2	29,4
BLOOM COLD	10,5	35x100 RECT	3	20,15	1,05	-	28	564,2	29,4
BLOOM WARM	10,5	35x100 RECT	3	20,15	1,05	-	28	564,2	29,4

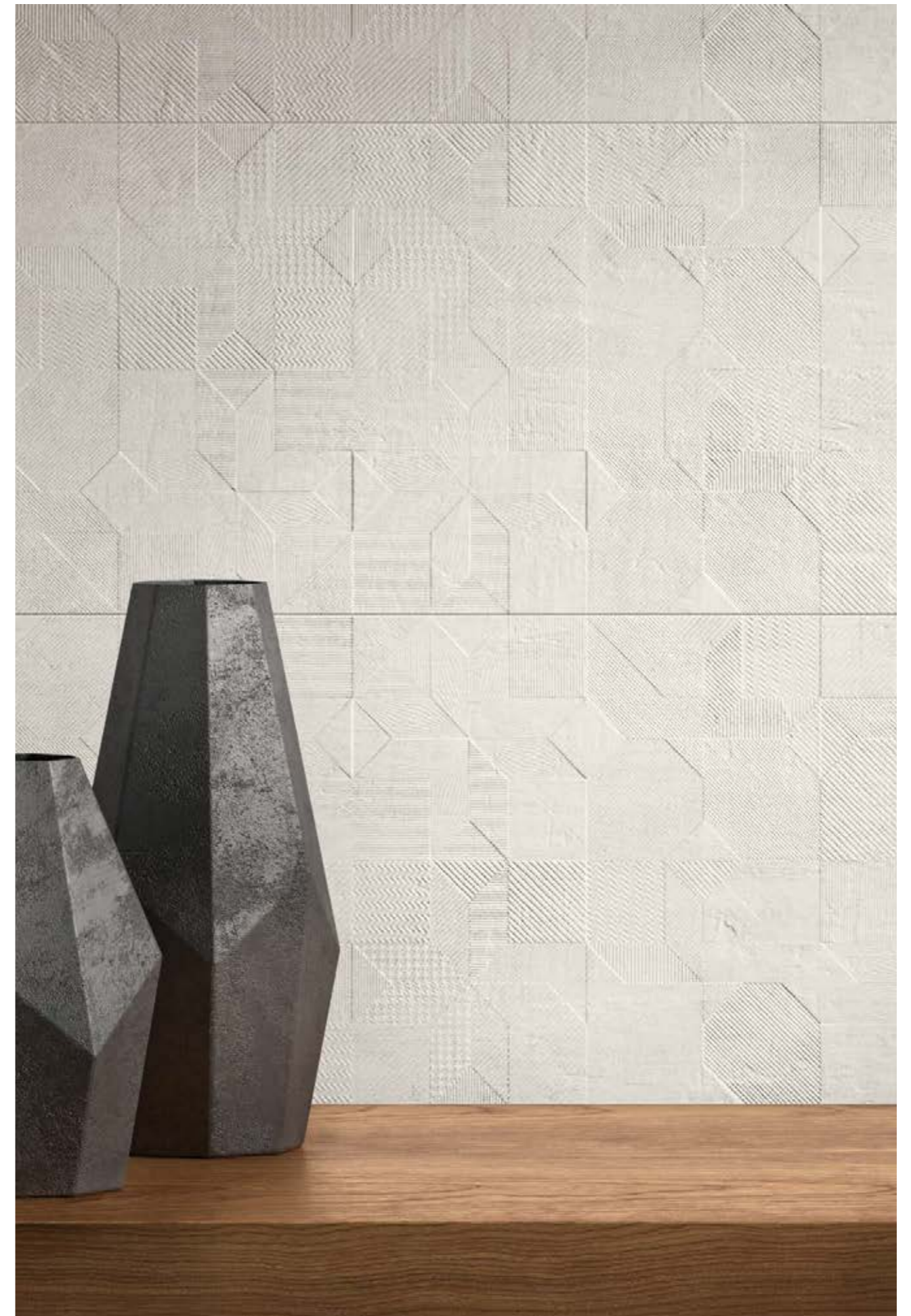

RIVESTIMENTO / WALL Enigma Wax 35x100 cm Rect - 13<sup>3/4</sup>"x39"

# Dati tecnici

## Technical data\_Technische Daten\_ Données techniques

Caratteristiche tecniche <i>Technical features_Technische Eigenschaften_ Caractéristiques techniques</i>	406
Informazioni per la posa <i>Laying information_Informationen für die Verlegung_ Informations pour la pose</i>	414
Resistenza allo scivolamento <i>Slip resistance_Rutschfestigkeit_Résistance au glissement</i>	417
Tabelle calibri <i>Size table_Formattabellen_Tableaux des calibres</i>	418
Pulizia <i>Cleaning_Reinigung_Nettoyage</i>	420
Panaria e l'ambiente <i>Panaria and the environment_Panaria und die Umwelt_ Panaria et l'environnement</i>	426
Certificazioni di sistema <i>Management system certifications_Qualitätssystem Zertifizierungen_ Certifications du système de production</i>	430
Certificazioni di prodotto <i>Product certification_Produktzertifizierung_ Certifications de produit</i>	432
Prodotti certificati <i>Certified products_Zertifizierte Erzeugnisse_ Produits certifiés</i>	435
Indice alfabetico dei prodotti <i>List of products in alphabetical order_Alphabetisches verzeichnis der Produkte_Index alphabétique des produits</i>	436
Condizioni generali di vendita <i>General terms and conditions of sale_Allgemeine Verkaufsbedingungen_ Conditions générales de vente</i>	440

# Caratteristiche tecniche

Technical features\_Technische Eigenschaften\_Caractéristiques techniques

## GRES PORCELLANATO\_PORCELAIN STONEWARE\_FEINSTEINZEUG\_GRÈS CÉRAME

Conforme\_according to\_Gemäß\_conforme: **ISO 13006 G - EN 14411 G Gruppo/Group Bla**

CARATTERISTICHE TECNICHE TECHNICAL FEATURES TECHNISCHE EIGENSCHAFTEN CARACTÉRISTIQUES TECHNIQUES	METODO DI PROVA TEST METHOD PRÜFMETHODE MÉTHODE D'ESSAI	REQUISITI PRESCRITTI REQUIRED VALUES VORGESCHRIEBENER WERT VALEURS REQUISES <b>ISO 13006-G EN 14411-G Gruppo Bla</b>	VALORI MEDI AVERAGE VALUES DURCHSCHNITTLICHE WERTE VALEURS MOYENNES <b>Non smaltato Unglazed UGL</b>	VALORI MEDI AVERAGE VALUES DURCHSCHNITTLICHE WERTE VALEURS MOYENNES <b>Levigato Polished Lappato UGL</b>	VALORI MEDI AVERAGE VALUES DURCHSCHNITTLICHE WERTE VALEURS MOYENNES <b>Smaltato Glazed GL</b>	
<b>ASSORBIMENTO D'ACQUA</b> WATER ABSORPTION WASSERABSORPTION ABSORPTION D'EAU	ISO 10545-3	≤ 0,5%	<b>0,05%</b>	<b>0,05%</b>	<b>0,05%</b>	
<b>SFORZO DI ROTTURA (S)</b> BREAKING STRENGTH (S) BRUCHLAST (S) CHARGE DE RUPTURE (S)	ISO 10545-4	≥ 1300 N	<b>CONFORME CONFORMS GEMÄSS CONFORME</b> <b>13600 N (20 mm)</b>	<b>CONFORME CONFORMS GEMÄSS CONFORME</b>	<b>CONFORME CONFORMS GEMÄSS CONFORME</b>	
<b>RESISTENZA ALLA FLESSIONE</b> MODULUS OF RUPTURE BIEGEFESTIGKEIT RÉSISTANCE À LA FLEXION	ISO 10545-4	≥ 35 N/mm <sup>2</sup>	<b>50 N/mm<sup>2</sup></b>	<b>50 N/mm<sup>2</sup></b>	<b>50 N/mm<sup>2</sup></b>	
<b>CLASSE REQUISITI MECCANICI</b> MECHANICAL CLASSIFICATION KLASSE MECHANISCHES ERFORDEERNIS RÉSISTANCE MÉCANIQUE	EN 1339	Requisito non previsto No provision Nicht erforderlich Non prévu	<b>U14 (20 mm) (2)</b>	-	-	
<b>RESISTENZA ALL'ABRASIONE PROFONDA</b> DEEP ABRASION RESISTANCE WIDERSTAND GEGEN TIEFENABRIEB RÉSISTANCE À L'ABRASION PROFONDE	ISO 10545-6	≤ 175 mm <sup>2</sup>	<b>145 mm<sup>2</sup></b>	<b>145 mm<sup>2</sup> 150 mm<sup>2</sup> (Lux)</b>	<b>NON APPLICABILE NOT APPLICABLE NON APPLICABLE NICHT ANWENDBAR</b>	
<b>DILATAZIONE TERMICA LINEARE</b> LINEAR THERMAL EXPANSION THERMISCHE DILATATION DILATATION THERMIQUE LINÉAIRE	ISO 10545-8	Requisito non previsto No provision Nicht erforderlich Non prévu	<b>α ≤ 7 x 10<sup>-6</sup> °C<sup>-1</sup></b>	<b>α ≤ 7 x 10<sup>-6</sup> °C<sup>-1</sup></b>	<b>α ≤ 7 x 10<sup>-6</sup> °C<sup>-1</sup></b>	
<b>RESISTENZA AL CAVILLO</b> CRAZING RESISTANCE HAARISBESTÄNDIGKEIT RÉSISTANCE AU TRESSILLAGE	ISO 10545-11	Nessuna alterazione No alterations Keine Änderung Aucune alteration	<b>NON APPLICABILE NOT APPLICABLE NICHT ANWENDBAR NON APPLICABLE</b>	<b>NON APPLICABILE NOT APPLICABLE NICHT ANWENDBAR NON APPLICABLE</b>	<b>RESISTENTE RESISTANT BESTÄNDIG RÉSISTANT</b>	
<b>RESISTENZA ALL'ATTACCO CHIMICO (1)</b> CHEMICAL RESISTANCE (1) CHEMISCHE BESTÄNDIGKEIT (1) RÉSISTANCE CHIMIQUE (1)	ISO 10545-13	Come indicato dal produttore As indicated by manufacturer Wie vom Hersteller angegeben Comme indiqué par le producteur	<b>LA - HA RESISTENTE RESISTANT BESTÄNDIG RÉSISTANT</b>	<b>LA - HA RESISTENTE RESISTANT BESTÄNDIG RÉSISTANT</b>	<b>LA - HA RESISTENTE RESISTANT BESTÄNDIG RÉSISTANT</b>	
<b>RESISTENZA ALLE MACCHIE</b> STAIN RESISTANCE FLECKENBESTÄNDIGKEIT RÉSISTANCE AUX TACHES	ISO 10545-14	Classe 3 min.	<b>5 RESISTENTE RESISTANT BESTÄNDIG RÉSISTANT</b>	<b>5 RESISTENTE RESISTANT BESTÄNDIG RÉSISTANT</b> <b>≥ 3 (Lux)</b>	<b>5 RESISTENTE RESISTANT BESTÄNDIG RÉSISTANT</b>	
<b>CESSIONE DI PIOMBO E CADMIO</b> LEAD AND CADMIUM GIVEN OFF ABGABE VON KADMIIUM UND BLEI DÉGAGEMENT DE CADMIUM ET PLOMB	ISO 10545-15	Requisito non previsto No provision Nicht erforderlich Non prévu	<b>NON APPLICABILE NOT APPLICABLE NICHT ANWENDBAR NON APPLICABLE</b>	<b>NON APPLICABILE NOT APPLICABLE NICHT ANWENDBAR NON APPLICABLE</b>	<b>RESISTENTE RESISTANT BESTÄNDIG RÉSISTANT</b>	
<b>RESISTENZA AL GELO</b> FROST RESISTANCE FROSTBESTÄNDIGKEIT RÉSISTANCE AU GEL	ISO 10545-12	Nessuna alterazione No alterations Keine Änderung Aucune alteration	<b>RESISTENTE RESISTANT BESTÄNDIG RÉSISTANT</b>	<b>RESISTENTE RESISTANT BESTÄNDIG RÉSISTANT</b>	<b>RESISTENTE RESISTANT BESTÄNDIG RÉSISTANT</b>	
<b>REAZIONE AL FUOCO</b> FIRE REACTION FEUERREAKTION RÉACTION AU FEU	EN 13823 EN 9239-1	CPR (UE) 305/2011 2000/147/CE UNI EN 13501-1	<b>CLASSE/CLASS A1 (wall)</b>	<b>CLASSE/CLASS A1 (wall)</b>	<b>CLASSE/CLASS A1 (wall)</b>	
<b>CONDUCIBILITÀ TERMICA</b> THERMAL CONDUCTIVITY WÄRMELEITFÄHIGKEIT CONDUCTIBILITÉ THERMIQUE	EN 12524	-	<b>α = 1,3 W/m<sup>2</sup>K α = 0.7 Btu/ft h<sup>2</sup>F</b>	<b>α = 1,3 W/m<sup>2</sup>K α = 0.7 Btu/ft h<sup>2</sup>F</b>	<b>α = 1,3 W/m<sup>2</sup>K α = 0.7 Btu/ft h<sup>2</sup>F</b>	
<b>CARATTERISTICHE DIMENSIONALI</b> DIMENSIONS SEITENMASSE CARACTÉRISTIQUES DIMENSIONNELLES	ISO 10545-2	<b>LUNGHEZZA E LARGHEZZA</b> LENGTH AND WIDTH LÄNGE UND BREITE LONGUEUR ET LARGEUR  <b>RETTILINEITÀ SPIGOLI</b> STRAIGHTNESS OF SIDES KANTENGERADHEIT RECTITUDE DES ARÊTES  <b>ORTOGONALITÀ</b> RECTANGULARITY RECHTWINKLIGKEIT ORTHOGONALITÉ  <b>PLANARITÀ</b> WARPAGE EBENFLÄCHIGKEIT PLANÉITÉ  <b>SPESSORE</b> THICKNESS STÄRKE ÉPAISSEUR	Non rettificato / Not rectified / Nicht Rektifiziert / Non Rectifié ± 0,6% max ± 2 mm  Rettificato / Rectified / Rektifiziert / Rectifié ± 0,3% max ± 1 mm  Non rettificato / Not rectified / Nicht Rektifiziert / Non Rectifié ± 0,5% max ± 1,5 mm  Rettificato / Rectified / Rektifiziert / Rectifié ± 0,3% max ± 0,8 mm  Non rettificato / Not rectified / Nicht Rektifiziert / Non Rectifié ± 0,5% max ± 2 mm  Rettificato / Rectified / Rektifiziert / Rectifié ± 0,3% max ± 1,5 mm  Non rettificato / Not rectified / Nicht Rektifiziert / Non Rectifié ± 0,5% max ± 2 mm  Rettificato / Rectified / Rektifiziert / Rectifié ± 0,4% max ± 1,8 mm  ± 5% max ± 0,5 mm	<b>CONFORME CONFORMS GEMÄSS CONFORME</b>  <b>CONFORME CONFORMS GEMÄSS CONFORME</b>  <b>CONFORME CONFORMS GEMÄSS CONFORME</b>  <b>CONFORME CONFORMS GEMÄSS CONFORME</b>  <b>CONFORME CONFORMS GEMÄSS CONFORME</b>  <b>CONFORME CONFORMS GEMÄSS CONFORME</b>  <b>CONFORME CONFORMS GEMÄSS CONFORME</b>	<b>CONFORME CONFORMS GEMÄSS CONFORME</b>  <b>CONFORME CONFORMS GEMÄSS CONFORME</b>  <b>CONFORME CONFORMS GEMÄSS CONFORME</b>  <b>CONFORME CONFORMS GEMÄSS CONFORME</b>  <b>CONFORME CONFORMS GEMÄSS CONFORME</b>  <b>CONFORME CONFORMS GEMÄSS CONFORME</b>	<b>CONFORME CONFORMS GEMÄSS CONFORME</b>  <b>CONFORME CONFORMS GEMÄSS CONFORME</b>  <b>CONFORME CONFORMS GEMÄSS CONFORME</b>  <b>CONFORME CONFORMS GEMÄSS CONFORME</b>  <b>CONFORME CONFORMS GEMÄSS CONFORME</b>

(1) Ad esclusione dell'acido fluoridrico e suoi derivati\_Excluding hydrofluoric acid and its derivatives\_Ausgenommen den Fluorwasserstoff und seine Derivate\_Sauf l'acide fluorhydrique et ses dérivés  
(2) Carrabile quando incollata su massetto. La classificazione si riferisce al solo formato quadrato, fino a 60x60 cm. Can be driven on when glued on screed. The classification only refers to the square format, up to 60x60 cm. Befahrbar bei Verkleben auf Estrich. Die Klassifikation bezieht sich nur auf das quadratische Format, bis zu 60x60 cm. Carrossable s'il est collé sur une chape. La classification ne concerne que le format carré, jusqu'à 60x60 cm

## GRES PORCELLANATO\_PORCELAIN TILES

Conforme\_according to: **ANSI A137.1 (glazed and unglazed porcelain tiles - P1 Class)**

CARATTERISTICHE TECNICHE TECHNICAL FEATURES	METODO DI PROVA TEST METHOD	REQUISITI PRESCRITTI REQUIRED VALUES <b>ANSI A137.1 Porcelain Tiles P1 Class</b>	VALORI MEDI AVERAGE VALUES <b>Non smaltato Unglazed UGL</b>	VALORI MEDI AVERAGE VALUES <b>Levigato Polished Lappato UGL</b>	VALORI MEDI AVERAGE VALUES <b>Smaltato Glazed GL</b>
<b>ASSORBIMENTO D'ACQUA</b> WATER ABSORPTION	ASTM C373	≤ 0.5%	<b>0.05%</b>	<b>0.05%</b>	<b>0.05%</b>
<b>SFORZO DI ROTTURA</b> BREAKING STRENGTH	ASTM C648	≥ 250 lbf	<b>CONFORME CONFORMS</b> <b>2800 LBF (20 mm)</b>	<b>CONFORME CONFORMS</b>	<b>CONFORME CONFORMS</b>
<b>RESISTENZA ALL'ABRASIONE PROFONDA</b> DEEP ABRASION RESISTANCE	ASTM C1243	≤ 175 mm <sup>2</sup>	<b>145 mm<sup>2</sup></b>	<b>145 mm<sup>2</sup> 150 mm<sup>2</sup> (Lux)</b>	<b>NON APPLICABILE NOT APPLICABLE</b>
<b>DILATAZIONE TERMICA LINEARE</b> LINEAR THERMAL EXPANSION	ASTM C372	Requisito non previsto No provision	<b>α ≤ 8 x 10<sup>-6</sup> °C<sup>-1</sup> α ≤ 4.4 x 10<sup>-6</sup> °F<sup>-1</sup></b>	<b>α ≤ 8 x 10<sup>-6</sup> °C<sup>-1</sup> α ≤ 4.4 x 10<sup>-6</sup> °F<sup>-1</sup></b>	<b>α ≤ 8 x 10<sup>-6</sup> °C<sup>-1</sup> α ≤ 4.4 x 10<sup>-6</sup> °F<sup>-1</sup></b>
<b>RESISTENZA AL CAVILLO</b> CRAZING RESISTANCE	ASTM C424	Nessuna alterazione No alterations	<b>NON APPLICABILE NOT APPLICABLE</b>	<b>NON APPLICABILE NOT APPLICABLE</b>	<b>RESISTENTE RESISTANT</b>
<b>RESISTENZA ALL'ATTACCO CHIMICO (1)</b> CHEMICAL RESISTANCE (1)	ASTM C650	Come indicato dal produttore As indicated by manufacturer	<b>A RESISTENTE RESISTANT</b>	<b>A RESISTENTE RESISTANT</b>	<b>A RESISTENTE RESISTANT</b>
<b>RESISTENZA ALLE MACCHIE</b> STAIN RESISTANCE	ASTM C1378	Come indicato dal produttore As indicated by manufacturer	<b>A RESISTENTE RESISTANT</b>	<b>A RESISTENTE RESISTANT C (Lux)</b>	<b>A RESISTENTE RESISTANT</b>
<b>CESSIONE DI PIOMBO E CADMIO</b> LEAD AND CADMIUM GIVEN OFF	ASTM C895	Requisito non previsto No provision	<b>NON APPLICABILE NOT APPLICABLE</b>	<b>NON APPLICABILE NOT APPLICABLE</b>	<b>RESISTENTE RESISTANT</b>
<b>RESISTENZA AL GELO</b> FROST RESISTANCE	ASTM C1026	Come indicato dal produttore As indicated by manufacturer	<b>RESISTENTE RESISTANT</b>	<b>RESISTENTE RESISTANT</b>	<b>RESISTENTE RESISTANT</b>
<b>FLAME SPREAD</b>	ASTM E84	-	<b>CLASS A</b>	<b>CLASS A</b>	<b>CLASS A</b>
<b>CARATTERISTICHE DIMENSIONALI</b> DIMENSIONS	ASTM C485	<b>PLANARITÀ DEI LATI</b> EDGE WARPAGE Rettificato / Rectified ± 0.40% or ± 0.05 inch* or ± 1.8 mm** *Whichever is less, for tiles up to 24" (610 mm) on any side **Applies to tiles larger than 24" (610 mm) on any side	<b>CONFORME CONFORMS</b>	<b>CONFORME CONFORMS</b>	<b>CONFORME CONFORMS</b>
<b>CARATTERISTICHE DIMENSIONALI</b> DIMENSIONS	ASTM C485	<b>PLANARITÀ DIAGONALI</b> DIAGONAL WARPAGE Rettificato / Rectified ± 0.40% or max ± 0.07"	<b>CONFORME CONFORMS</b>	<b>CONFORME CONFORMS</b>	<b>CONFORME CONFORMS</b>
<b>CARATTERISTICHE DIMENSIONALI</b> DIMENSIONS	ASTM C499	<b>DIMENSIONI NOMINALI</b> NOMINAL DIMENSIONS Rettificato / Rectified - 3.0% / +2.0% of nominal dimensions	<b>± 1.5%</b>	<b>± 1.5%</b>	<b>± 1.5%</b>
<b>CARATTERISTICHE DIMENSIONALI</b> DIMENSIONS	ASTM C499	<b>INTERVALLO CALIBRO</b> CALIBER RANGE Rettificato / Rectified ± 0.25% or max ± 0.03"	<b>CONFORME CONFORMS</b>	<b>CONFORME CONFORMS</b>	<b>CONFORME CONFORMS</b>
<b>CARATTERISTICHE DIMENSIONALI</b> DIMENSIONS	ASTM C499	<b>SPESSORE</b> THICKNESS ≤ 0.040"	<b>≤ 0.030"</b>	<b>≤ 0.030"</b>	<b>≤ 0.030"</b>
<b>CARATTERISTICHE DIMENSIONALI</b> DIMENSIONS	ASTM C502	<b>PARALLELISMO DEI LATI</b> WEDGING Rettificato / Rectified ± 0.25% or max ± 0.03"	<b>CONFORME CONFORMS</b>	<b>CONFORME CONFORMS</b>	<b>CONFORME CONFORMS</b>

(1) Ad esclusione dell'acido fluoridrico e suoi derivati\_Excluding hydrofluoric acid and its derivatives

# Caratteristiche tecniche

Technical features\_Technische Eigenschaften\_Caractéristiques techniques

## Zero.3 GRES PORCELLANATO LAMINATO\_LAMINATED PORCELAIN STONEWARE\_LAMINIERTES FEINSTEINZEUG\_GRÈS CÉRAME LAMINÉ

Conforme\_according to\_Gemäß\_conforme: ISO 13006-G ed EN 14411-G Gruppo/Group Bla- UGL

CARATTERISTICHE TECNICHE TECHNICAL FEATURES TECHNISCHE EIGENSCHAFTEN CARACTÉRISTIQUES TECHNIQUES	METODO DI PROVA TEST METHOD PRÜFMETHODE MÉTHODE D'ESSAI	REQUISITI PRESCRITTI REQUIRED VALUES VORGESCHRIEBENER WERT VALEURS REQUISES ISO 13006-G ed EN 14411-G Gruppo Bla-UGL	VALORI MEDI AVERAGE VALUES DURCHSCHNITTLICHE WERTE VALEURS MOYENNES Zero.3 3plus*	VALORI MEDI AVERAGE VALUES DURCHSCHNITTLICHE WERTE VALEURS MOYENNES Zero.3 5plus*	VALORI MEDI AVERAGE VALUES DURCHSCHNITTLICHE WERTE VALEURS MOYENNES Zero.3 6mm
ASSORBIMENTO D'ACQUA WATER ABSORPTION WASSERABSORPTION ABSORPTION D'EAU	ISO 10545-3	≤ 0,5%	0,1% (1)	0,1% (1)	0,1%
RESISTENZA ALLA FLESSIONE MODULUS OF RUPTURE BIEGEFESTIGKEIT RÉSISTANCE A LA FLEXION	ISO 10545-4	≥ 35 N/mm <sup>2</sup>	50 N/mm <sup>2</sup>	50 N/mm <sup>2</sup>	50 N/mm <sup>2</sup>
RESISTENZA ALL'ABRASIONE PROFONDA DEEP ABRASION RESISTANCE WIDERSTAND GEGEN TIEFENABRIEB RÉSISTANCE A L'ABRASION PROFONDE	ISO 10545-6	≤ 175 mm <sup>3</sup>	CONFORME CONFORMS GEMÄSS CONFORME	CONFORME CONFORMS GEMÄSS CONFORME	CONFORME CONFORMS GEMÄSS CONFORME
DILATAZIONE TERMICA LINEARE LINEAR THERMAL EXPANSION THERMISCHE DILATATION DILATATION THERMIQUE LINÉAIRE	ISO 10545-8	Requisito non previsto No provision Nicht erforderlich Non prévu	α ≤ 7 x 10 <sup>-6</sup> °C <sup>-1</sup>	α ≤ 7 x 10 <sup>-6</sup> °C <sup>-1</sup>	α ≤ 7 x 10 <sup>-6</sup> °C <sup>-1</sup>
RESISTENZA ALL'ATTACCO CHIMICO (2) CHEMICAL RESISTANCE (2) CHEMISCHE BESTÄNDIGKEIT (2) RÉSISTANCE CHIMIQUE (2)	ISO 10545-13	Come indicato dal produttore As indicated by manufacturer Wie vom Hersteller angegeben Comme indiqué par le producteur	LA - HA RESISTENTE RESISTANT BESTÄNDIG RÉSISTANT	LA - HA RESISTENTE RESISTANT BESTÄNDIG RÉSISTANT LB - HB (Lux)	LA - HA RESISTENTE RESISTANT BESTÄNDIG RÉSISTANT LB - HB (Lux)
RESISTENZA ALLE MACCHIE STAIN RESISTANCE FLECKBESTÄNDIGKEIT RÉSISTANCE AUX TACHES	ISO 10545-14	Classe 3 min.	5 RESISTENTE RESISTANT BESTÄNDIG RÉSISTANT	5 RESISTENTE RESISTANT BESTÄNDIG RÉSISTANT ≥ 3 (Lux)	5 RESISTENTE RESISTANT BESTÄNDIG RÉSISTANT ≥ 3 (Lux)
RESISTENZA AL GELO FROST RESISTANCE FROSTBESTÄNDIGKEIT RÉSISTANCE AU GEL	ISO 10545-12	Nessuna alterazione No alterations Keine Änderung Aucune altération	RESISTENTE RESISTANT BESTÄNDIG RÉSISTANT	RESISTENTE RESISTANT BESTÄNDIG RÉSISTANT	RESISTENTE RESISTANT BESTÄNDIG RÉSISTANT
REAZIONE AL FUOCO FIRE REACTION FEUERREAKTION RÉACTION AU FEU	EN 13823 EN 9239-1	CPR (UE) 305/2011 2000/147/CE UNI EN 13501-1	CLASSE/CLASS A2 - s1, d0 (wall) CLASSE/CLASS A2 <sub>fl</sub> - s1 (floor)	CLASSE/CLASS A2 - s1, d0 (wall) CLASSE/CLASS A2 <sub>fl</sub> - s1 (floor)	CLASSE/CLASS A1 (wall) CLASSE/CLASS A1 <sub>fl</sub> (floor)
CONDUCEBILITÀ TERMICA THERMAL CONDUCTIVITY WÄRMELEITFÄHIGKEIT CONDUCTIBILITÉ THERMIQUE	EN 12524	-	α = 1,3 W/m <sup>2</sup> K α = 0,7 Btu/ft h <sup>2</sup> F	α = 1,3 W/m <sup>2</sup> K α = 0,7 Btu/ft h <sup>2</sup> F	α = 1,3 W/m <sup>2</sup> K α = 0,7 Btu/ft h <sup>2</sup> F
CARATTERISTICHE DIMENSIONALI DIMENSIONS SEITENMASSE CARACTÉRISTIQUES DIMENSIONNELLES	ISO 10545-2	<b>LUNGHEZZA E LARGHEZZA</b> LENGTH AND WIDTH LÄNGE UND BREITE LONGUEUR ET LARGEUR	± 0,3% max ± 1 mm	CONFORME CONFORMS GEMÄSS CONFORME	CONFORME CONFORMS GEMÄSS CONFORME
RETTILINEITÀ SPIGOLI STRAIGHTNESS OF SIDES KANTENGERADHEIT RECTITUDE DES ARÊTES		± 0,3% max ± 0,8 mm	CONFORME CONFORMS GEMÄSS CONFORME	CONFORME CONFORMS GEMÄSS CONFORME	CONFORME CONFORMS GEMÄSS CONFORME
ORTOGONALITÀ RECTANGULARITY RECHTWINKLIGKEIT ORTHOGONALITÉ		± 0,3% max ± 1,5 mm	CONFORME CONFORMS GEMÄSS CONFORME	CONFORME CONFORMS GEMÄSS CONFORME	CONFORME CONFORMS GEMÄSS CONFORME
PLANARITÀ WARPAGE EBENFLÄCHIGKEIT PLANÉITÉ		± 0,4% max ± 1,8 mm	CONFORME CONFORMS GEMÄSS CONFORME	CONFORME CONFORMS GEMÄSS CONFORME	CONFORME CONFORMS GEMÄSS CONFORME
SPESSORE THICKNESS STÄRKE ÉPAISSEUR		± 5% max ± 0,5 mm	CONFORME CONFORMS GEMÄSS CONFORME	CONFORME CONFORMS GEMÄSS CONFORME	CONFORME CONFORMS GEMÄSS CONFORME

(1) Valore riferito al solo materiale ceramico\_Value referred to ceramic material only\_Der Wert bezieht sich ausschließlich auf keramisches Material\_Valeur qui se réfère uniquement au matériel céramique  
(2) Ad esclusione dell'acido fluoridrico e suoi derivati\_Excluding hydrofluoric acid and its derivatives\_Ausgenommen den Fluorwasserstoff und seine Derivate\_Sauf l'acide fluorhydrique et ses dérivés  
(\*) Plus: lastra + fibra di vetro\_Plus: slab and fibreglass\_Plus: Fliese + Glass- Gewebe\_Plus: dalle + fibre de verres

## Zero.3 GRES PORCELLANATO LAMINATO\_LAMINATED PORCELAIN STONEWARE

Conforme\_according to: ANSI A137.3 (back layered gauged porcelain slabs 3plus-5plus / gauged porcelain slabs 6mm - UGL)

CARATTERISTICHE TECNICHE TECHNICAL FEATURES	METODO DI PROVA TEST METHOD	REQUISITI PRESCRITTI REQUIRED VALUES ANSI A137.3	VALORI MEDI AVERAGE VALUES Zero.3 3plus*	VALORI MEDI AVERAGE VALUES Zero.3 5plus*	VALORI MEDI AVERAGE VALUES Zero.3 5plus*
ASSORBIMENTO D'ACQUA WATER ABSORPTION	ASTM C373	≤ 0.5%	0.1% (1)	0.1% (1)	0.1%
RESISTENZA ALLA FLESSIONE MODULUS OF RUPTURE	ASTM C1505	≥ 6000 lbf	≥ 6000 lbf	≥ 6000 lbf	≥ 6000 lbf
CARICO DI ROTTURA BREAKING STRENGTH	ASTM C1505	Thickness 3.5-4.9 mm: ≥ 85 lbf Thickness 5-6.5 mm: ≥ 175 lbf	≥ 85 lbf	≥ 175 lbf	≥ 175 lbf
RESISTENZA ALL'ABRASIONE PROFONDA DEEP ABRASION RESISTANCE	ASTM C1243	≤ 175 mm <sup>3</sup>	CONFORME CONFORMS	CONFORME CONFORMS	CONFORME CONFORMS
DILATAZIONE TERMICA LINEARE LINEAR THERMAL EXPANSION	ASTM C372	Requisito non previsto No provision	α ≤ 8 x 10 <sup>-6</sup> °C <sup>-1</sup> α ≤ 4.4 x 10 <sup>-6</sup> °F <sup>-1</sup>	α ≤ 8 x 10 <sup>-6</sup> °C <sup>-1</sup> α ≤ 4.4 x 10 <sup>-6</sup> °F <sup>-1</sup>	α ≤ 8 x 10 <sup>-6</sup> °C <sup>-1</sup> α ≤ 4.4 x 10 <sup>-6</sup> °F <sup>-1</sup>
RESISTENZA ALL'ATTACCO CHIMICO (2) CHEMICAL RESISTANCE (2)	ASTM C650	Come indicato dal produttore As indicated by manufacturer	A RESISTENTE RESISTANT	A RESISTENTE RESISTANT C (Lux)	A RESISTENTE RESISTANT C (Lux)
RESISTENZA ALLE MACCHIE STAIN RESISTANCE	ASTM C1378	Come indicato dal produttore As indicated by manufacturer	A RESISTENTE RESISTANT	A RESISTENTE RESISTANT C (Lux)	A RESISTENTE RESISTANT C (Lux)
RESISTENZA AL GELO FROST RESISTANCE	ASTM C1026	Come indicato dal produttore As indicated by manufacturer	RESISTENTE RESISTANT	RESISTENTE RESISTANT	RESISTENTE RESISTANT
FLAME SPREAD	ASTM E84	-	CLASS A	CLASS A	CLASS A
CARATTERISTICHE DIMENSIONALI DIMENSIONS	ASTM C499	<b>DIMENSIONI NOMINALI</b> NOMINAL DIMENSIONS	Max ±3.0% of nominal dimensions	CONFORME CONFORMS	CONFORME CONFORMS
INTERVALLO CALIBRO CALIBER RANGE	ASTM C499	Max ±0.25% or max ±0.03*	CONFORME CONFORMS	CONFORME CONFORMS	CONFORME CONFORMS
SPESSORE THICKNESS	ASTM C499	Max ±0.5 mm (±0.02") from nominal thickness	CONFORME CONFORMS	CONFORME CONFORMS	CONFORME CONFORMS
VARIAZIONE SPESSORE THICKNESS VARIATION	ASTM C499	0.5 mm (0.02")	CONFORME CONFORMS	CONFORME CONFORMS	CONFORME CONFORMS
PARALLELISMO DEI LATI WEDGING	ASTM C502	Max ±0.25% or max ±0.03*	CONFORME CONFORMS	CONFORME CONFORMS	CONFORME CONFORMS

















(1) Valore riferito al solo materiale ceramico\_Value referred to ceramic material only  
(2) Ad esclusione dell'acido fluoridrico e suoi derivati\_Excluding hydrofluoric acid and its derivatives  
(\*) Plus: lastra + fibra di vetro\_Plus: slab and fibreglass

# Caratteristiche tecniche

Technical features\_Technische Eigenschaften\_Caractéristiques techniques

## RIVESTIMENTO MONOPOROSA IN PASTA BIANCA SMALTATA\_GLAZED WHITE BODY POROUS SINGLE-FIRED WALL TILES\_ GLASIERTE WEISSSCHÄRBIGE WANDFLIESE\_FAÏENCES PÂTE BLANCHE ÉMAILLÉ















Conforme\_according to\_Gemäß\_conforme: **ISO 13006 L - EN 14411 L Gruppo/Group BIII - GL**

CARATTERISTICHE TECNICHE TECHNICAL FEATURES TECHNISCHE EIGENSCHAFTEN CARACTÉRISTIQUES TECHNIQUES	METODO DI PROVA TEST METHOD PRÜFMETHODE MÉTHODE D'ESSAI	REQUISITI PRESCRITTI REQUIRED VALUES VORGESCHRIEBENER WERT VALEURS REQUISES <b>ISO 13006-L EN 14411-L Gruppo/ Group BIII GL</b>	VALORI MEDI AVERAGE VALUES DURCHSCHNITTliche WERTE VALEURS MOYENNES <b>Smaltato/ Glazed BIII GL</b>
 <b>ASSORBIMENTO D'ACQUA</b> WATER ABSORPTION WASSERABSORPTION ABSORPTION D'EAU	ISO 10545-3	> 10%	<b>&gt; 10%</b>
 <b>RESISTENZA ALLA FLESSIONE</b> MODULUS OF RUPTURE BIEGEFESTIGKEIT RÉSISTANCE À LA FLEXION	ISO 10545-4	≥ 12 N/mm <sup>2</sup>	<b>18 N/mm<sup>2</sup></b>
 <b>SFORZO DI ROTTURA (S)</b> BREAKING STRENGTH (S) BRUCHLAST (S) CHARGE DE RUPTURE (S)	ISO 10545-4	≥ 600 N	<b>≥ 600 N</b>
 <b>DILATAZIONE TERMICA LINEARE</b> LINEAR THERMAL EXPANSION THERMISCHE DILATATION DILATATION THERMIQUE LINÉAIRE	ISO 10545-8	Requisito non previsto No provision Nicht erforderlich Non prévu	<b>α ≤ 7 X 10<sup>-6</sup> °C<sup>-1</sup></b>
 <b>RESISTENZA AL CAVILLO</b> CRAZING RESISTANCE HAARISBESTÄNDIGKEIT RÉSISTANCE AU TRESSILLAGE	ISO 10545-11	Nessuna alterazione No alterations Keine Änderung Aucune altération	<b>RESISTENTE RESISTANT BESTÄNDIG RÉSISTANT</b>
 <b>RESISTENZA ALL'ATTACCO CHIMICO (1)</b> CHEMICAL RESISTANCE (1) CHEMISCHE BESTÄNDIGKEIT (1) RÉSISTANCE CHIMIQUE (1)	ISO 10545-13	Come indicato dal produttore As indicated by manufacturer Wie vom Hersteller angegeben Comme indiqué par le producteur	<b>LA - HA RESISTENTE RESISTANT BESTÄNDIG RÉSISTANT</b>
 <b>RESISTENZA ALLE MACCHIE</b> STAIN RESISTANCE FLECKENBESTÄNDIGKEIT RÉSISTANCE AUX TACHES	ISO 10545-14	Classe 3 min.	<b>5 RESISTENTE RESISTANT BESTÄNDIG RÉSISTANT</b>
 <b>CESSIONE DI PIOMBO E CADMIO</b> LEAD AND CADMIUM GIVEN OFF ABGABE VON KADMIIUM UND BLEI DÉGAGEMENT DE CADMIUM ET PLOMB	ISO 10545-15	Requisito non previsto No provision Nicht erforderlich Non prévu	<b>RESISTENTE RESISTANT BESTÄNDIG RÉSISTANT</b>
 <b>RESISTENZA AL GELO</b> FROST RESISTANCE FROSTBESTÄNDIGKEIT RÉSISTANCE AU GEL	ISO 10545-12	Come indicato dal produttore As indicated by manufacturer Wie vom Hersteller angegeben Comme indiqué par le producteur	<b>NON RESISTENTE NOT RESISTANT NICHT BESTÄNDIG PAS RÉSISTANT</b>
 <b>REAZIONE AL FUOCO</b> FIRE REACTION FEUERREAKTION RÉACTION AU FEU	EN 13823 EN 9239-1	CPR (UE) 305/2011 2000/147/CE UNI EN 13501-1	<b>CLASSE/CLASS A1 (wall) CLASSE/CLASS A1<sub>w</sub> (floor)</b>
 <b>CONDUCIBILITÀ TERMICA</b> THERMAL CONDUCTIVITY WÄRMELEITFÄHIGKEIT CONDUCTIBILITÉ THERMIQUE	EN 12524	-	<b>α = 0,7 W/m<sup>2</sup>K α = 0,4 Btu/ft h<sup>2</sup>F</b>
 <b>CARATTERISTICHE DIMENSIONALI</b> DIMENSIONS SEITENMASSE CARACTÉRISTIQUES DIMENSIONNELLES	ISO 10545-2	<b>LUNGHEZZA E LARGHEZZA</b> LENGTH AND WIDTH LÄNGE UND BREITE LONGUEUR ET LARGEUR	Rettificato / Rectified / Rektifiziert / Rectifié ± 0,3% max ± 1 mm
 <b>RETILINEITÀ SPIGOLI</b> STRAIGHTNESS OF SIDES KANTENGERADHEIT RECTITUDE DES ARÊTES		Rettificato / Rectified / Rektifiziert / Rectifié ± 0,3% max ± 0,8 mm	<b>CONFORME CONFORMS GEMÄSS CONFORME</b>
 <b>ORTOGONALITÀ</b> RECTANGULARITY RECHTWINKLIGKEIT ORTHOGONALITÉ		Rettificato / Rectified / Rektifiziert / Rectifié ± 0,3% max ± 1,5 mm	<b>CONFORME CONFORMS GEMÄSS CONFORME</b>
 <b>PLANARITÀ</b> WARPAGE EBENFLÄCHIGKEIT PLANÉITÉ		Rettificato / Rectified / Rektifiziert / Rectifié ± 0,4% max ± 1,8 mm	<b>CONFORME CONFORMS GEMÄSS CONFORME</b>
 <b>SPESSORE</b> THICKNESS STÄRKE ÉPAISSEUR		± 10% max ± 0,5 mm	<b>CONFORME CONFORMS GEMÄSS CONFORME</b>

(1) Ad esclusione dell'acido fluoridrico e suoi derivati\_Excluding hydrofluoric acid and its derivatives\_Ausgenommen den Fluorwasserstoff und seine Derivate\_Sauf l'acide fluorhydrique et ses dérivés

## RIVESTIMENTO MONOPOROSA IN PASTA BIANCA SMALTATA\_GLAZED WHITE BODY POROUS SINGLE-FIRED WALL TILES

Conforme\_according to: **ANSI A137.1 (glazed wall tiles - P4 Class)**

CARATTERISTICHE TECNICHE TECHNICAL FEATURES	METODO DI PROVA TEST METHOD	REQUISITI PRESCRITTI REQUIRED VALUES <b>ANSI A137.1 wall tiles P4 Class</b>	VALORI MEDI AVERAGE VALUES <b>Smaltato Glazed - GL</b>
 <b>ASSORBIMENTO D'ACQUA</b> WATER ABSORPTION	ASTM C373	7% < e ≤ 20%	<b>7% &lt; e ≤ 20%</b>
 <b>SFORZO DI ROTTURA</b> BREAKING STRENGTH	ASTM C648	≥ 125 lbf	<b>≥ 125 lbf</b>
 <b>DILATAZIONE TERMICA LINEARE</b> LINEAR THERMAL EXPANSION	ASTM C372	Requisito non previsto No provision	<b>α ≤ 8 x 10<sup>-6</sup> °C<sup>-1</sup> α ≤ 4.4 x 10<sup>-6</sup> °F<sup>-1</sup></b>
 <b>RESISTENZA AL CAVILLO</b> CRAZING RESISTANCE	ASTM C424	Nessuna alterazione No alterations	<b>RESISTENTE RESISTANT</b>
 <b>RESISTENZA ALL'ATTACCO CHIMICO (1)</b> CHEMICAL RESISTANCE (1)	ASTM C650	Come indicato dal produttore As indicated by manufacturer	<b>A RESISTENTE RESISTANT</b>
 <b>RESISTENZA ALLE MACCHIE</b> STAIN RESISTANCE	ASTM C1378	Come indicato dal produttore As indicated by manufacturer	<b>A RESISTENTE RESISTANT</b>
 <b>CESSIONE DI PIOMBO E CADMIO</b> LEAD AND CADMIUM GIVEN OFF	ASTM C895	Requisito non previsto No provision	<b>RESISTENTE RESISTANT</b>
 <b>RESISTENZA AL GELO</b> FROST RESISTANCE	ASTM C1026	Come indicato dal produttore As indicated by manufacturer	<b>NON RESISTENTE NOT RESISTANT</b>
 <b>FLAME SPREAD</b>	ASTM E84	-	<b>CLASS A</b>
 <b>CARATTERISTICHE DIMENSIONALI</b> DIMENSIONS	ASTM C485	<b>PLANARITÀ DEI LATI</b> EDGE WARPAGE	Rettificato / Rectified - 0.30% / + 0.40% or max - 0.04" / +0.05" Calibrato / Calibrated - 0.30% / + 0.40% or max - 0.04" / +0.05" <b>CONFORME CONFORMS</b>
 <b>CARATTERISTICHE DIMENSIONALI</b> DIMENSIONS	ASTM C485	<b>PLANARITÀ DIAGONALI</b> DIAGONAL WARPAGE	Rettificato / Rectified - 0.30% / + 0.40% or max - 0.05" / +0.07" Calibrato / Calibrated - 0.30% / + 0.40% or max - 0.05" / +0.07" <b>CONFORME CONFORMS</b>
 <b>CARATTERISTICHE DIMENSIONALI</b> DIMENSIONS	ASTM C499	<b>DIMENSIONI NOMINALI</b> NOMINAL DIMENSIONS	Rettificato / Rectified ±2.0% of nominal dimensions Calibrato / Calibrated ±2.0% of nominal dimensions <b>± 1.0%</b>
 <b>CARATTERISTICHE DIMENSIONALI</b> DIMENSIONS	ASTM C499	<b>INTERVALLO CALIBRO</b> CALIBER RANGE	Rettificato / Rectified ± 0.25% or max ± 0.03" Calibrato / Calibrated ± 0.30% or max ± 0.04" <b>CONFORME CONFORMS</b>
 <b>CARATTERISTICHE DIMENSIONALI</b> DIMENSIONS	ASTM C499	<b>SPESSORE</b> THICKNESS	≤ 0.031" ≤ 0.031" <b>CONFORME CONFORMS</b>
 <b>CARATTERISTICHE DIMENSIONALI</b> DIMENSIONS	ASTM C502	<b>PARALLELISMO DEI LATI</b> WEDGING	Rettificato / Rectified ± 0.25% or max ± 0.03" Calibrato / Calibrated ± 0.40% or max ± 0.05" <b>CONFORME CONFORMS</b>

(1) Ad esclusione dell'acido fluoridrico e suoi derivati\_Excluding hydrofluoric acid and its derivatives

# Caratteristiche tecniche

Technical features\_Technische Eigenschaften\_Caractéristiques techniques

## PRODOTTO DECORATO CON TECNOLOGIA A FREDDO\_PRODUCTS DECORATED WITH COLD DECORATING TECHNOLOGY\_

KALTECHNOLOGIE DEKORIERTEN PRODUKTS\_PRODUIT DÉCORÉ AVEC TECHNOLOGIE À FROID

Collezione Glam\_Glam collection\_Kollektion Glam\_Collection Glam / Decori Flora collezione Experience\_Flora decors Experience collection\_Flora-Dekore Experience Kollektion\_décors Flora collection Experience

**Le lastre sono decorate mediante la tecnologia di stampa digitale a freddo, che permette di raggiungere risultati estetici e cromatici di eccezionale qualità. Le grafiche vengono impresse ad altissima risoluzione sul supporto ceramico, mantenendo invariati i colori brillanti e le sfumature dei motivi decorativi.**

The slabs are decorated using digital cold printing technology, with which aesthetic, chromatic results of exceptional quality are achieved. The graphics are imprinted at very high resolution on the ceramic substrate, keeping the brilliant colors and shades of the decorative designs unchanged.

Die Platten werden nach dem Brennen im Digitaldruckverfahren dekoriert, mit dem sich optisch und farblich Ergebnisse von höchster Qualität erzielen lassen. Die Motive werden mit extrem hoher Auflösung auf die Keramikfliese gedruckt, wobei die Leuchtkraft der Farben und die Nuancen der Motive perfekt erhalten bleiben.

Les dalles sont décorées grâce à la technologie d'impression numérique à froid, qui permet d'obtenir des résultats esthétiques et chromatiques d'une qualité exceptionnelle. Les graphismes sont imprimés en haute résolution sur le support céramique, en préservant la brillance des couleurs et les nuances des motifs décoratifs.

## CARATTERISTICHE PRODOTTO\_PRODUCT CHARACTERISTICS\_PRODUKTMERKMALE\_CHARACTERISTIQUES DU PRODUIT

Rivestimenti decorati da interno\_Interior decorated wall coverings\_Dekorierte Wandbelege für Innenbereich\_Décors pour revêtement mural intérieur

<b>DESTINAZIONI D'USO</b> INTENDED USES EINSATZBEREICHE UTILISATIONS PRÉVUES	<b>Idonei esclusivamente per la posa a parete in ambienti interni; non posare a pavimento e a rivestimento in luoghi esterni.</b> Intended exclusively for the cladding of interior walls; do not use as flooring or to clad exterior spaces. Geeignet ausschließlich für die Wandverlegung in Innenbereichen; nicht für das Verlegen von Fußböden und Wandverkleidung im Außenbereich geeignet. Approprié exclusivement pour la pose au mur dans les environnements intérieurs; ne pas poser au sol et en revêtement dans les environnements extérieurs.
<b>RESISTENZA ALLE MACCHIE ISO 10545-14</b> STAIN RESISTANCE FLECKENBESTÄNDIGKEIT RÉSISTANCE AUX TACHES	<b>Conforme alla Classe 5. Resiste alle macchie di alimenti e bevande. Non resiste alla tintura di iodio, blu di metilene, pennarello indelebile.</b> Class-5, resistance to food and beverage stains. Not resistant to iodine dye, methylene blue, or permanent marker. Fleckenbeständig gegen Lebensmittel- und Getränkeflecken, konform mit Klasse 5 Nicht beständig gegen Jodfarben, Methylenblau, Permanentmarker. Résiste aux taches d'aliments et boissons conforme à la classe 5. Ne résiste pas à la teinture d'iode, bleu de méthylène, feutre indélébile.
<b>RESISTENZA ATTACCO CHIMICO ISO 10545-13</b> CHEMICAL RESISTANCE CHEMISCHE BESTÄNDIGKEIT RÉSISTANCE CHIMIQUE	<b>LB-HB</b>
<b>RESISTENZA SUPERFICIALE</b> SURFACE STRENGTH OBERFLÄCHENWIDERSTAND SURFACE RÉSISTANTE	<b>La decorazione di questi prodotti non ha una buona resistenza ai graffi di oggetti acuminati molto duri come ad esempio metallo, pietra, vetro e gres. Prestare la massima attenzione alla movimentazione durante le operazioni di posa evitando di urtare o strisciare utensili ed oggetti duri acuminati sulla superficie.</b> This product's decoration is not scratch resistant to hard, sharp objects such as metal, stone, glass, and stoneware. Be extremely careful when handling the product during installation, making sure not to bump or slide tools or other sharp objects against the surface. Die Dekoration dieser Produkte ist nicht sehr widerstandsfähig gegen Kratzer durch sehr harte spitze Gegenstände, zum Beispiel aus Metall, Stein, Glas und Feinsteinzeug. Fahren Sie bei der Handhabung der Platten während der Verlegung besonders vorsichtig fort und vermeiden Sie Stöße oder Kratzer auf der Oberfläche durch Werkzeuge oder andere harte Gegenstände. La décoration de ces produits ne résiste pas bien aux rayures causées par les objets pointus et très durs tels que le métal, la pierre, le verre ou le grès, entre autres. Faire particulièrement attention à la manipulation au cours des opérations de pose, en évitant de heurter ou de faire glisser les outils et les objets durs et pointus sur la surface.

## AVVERTENZE PER LA POSA E LA PULIZIA\_CAUTION FOR INSTALLATION AND CLEANING\_HINWEISE ZUR VERLEGUNG UND REINIGUNG\_

MISES EN GARDE POUR LA POSE ET LE NETTOYAGE

Collezione Glam\_Glam collection\_Kollektion Glam\_Collection Glam / Decori Flora collezione Experience\_Flora decors Experience collection\_Flora-Dekore Experience Kollektion\_décors Flora collection Experience

<b>POSA</b> INSTALLATION VERLEGUNG POSE	<b>Spalmare la colla con spatola dentata di almeno 5 mm sul fondo della parete ed applicare la lastra a muro. Trattandosi di rivestire una parete di ambiente interno non è necessaria la spalmatura nel retro della lastra. Per un miglior risultato estetico si consiglia la posa distanziando le lastre con solo 1 mm di fuga. Non usare sistemi meccanici livellanti poiché la loro rimozione potrebbe danneggiare la superficie. Battere bene la lastra con spatola gommata al fine di allineare le lastre fra di loro.</b> Spread the adhesive using a notched trowel (of at least 5 mm) on the base of the wall and apply the slab. As this this product is to be used for cladding in interior spaces, it is not necessary to apply adhesive to the back of the slab (back-butter). For optimum aesthetic results it is best to leave only 1 mm of space between the slabs. Do not use mechanical levelling systems as their removal could damage the surface. Use a rubber trowel to tap the slabs so that they are perfectly in line with one another. Den Kleber mit dem Zahnspatel von mindestens 5 mm auf dem Wanduntergrund auftragen und die Platte an der Wand ankleben. Da es sich hierbei um eine Innenwand handelt braucht keine Klebschicht auch auf der Rückseite der Platte aufgetragen werden. Für ein besseres ästhetisches Ergebnis wird empfohlen die Platten mit einem Fugenabstand von 1 mm zu verlegen. Keine nivellierenden mechanischen Hilfsmittel verwenden, da das Entfernen derselben die Oberflächen beschädigen könnten. Die Platte mit einem Gummispachtel fest anklopfen und die Platten untereinander ausrichten. Étaler le mortier-colle sur le mur à l'aide d'un peigne crantée d'au moins 5 mm, puis appliquer dessus la dalle au mur. Comme il s'agit d'habiller un mur d'espace intérieur, il n'est pas nécessaire d'étaler le mortier-colle au dos de la dalle. Pour un meilleur résultat esthétique, il est conseillé d'effectuer la pose en séparant les dalles avec un joint de 1 mm uniquement. Ne pas utiliser de systèmes mécaniques de nivellement car leur élimination peut endommager la surface. Bien tapoter les dalles à l'aide d'une spatule en caoutchouc afin de les aligner parfaitement les unes avec les autres.
<b>STUCCATURA</b> GROUTING VERFUGUNG JOINTOIEMENT	<b>Sigillare le fughe solo con stucchi cementizi, non usare stucchi epossidici.</b> Seal the joints using only cementitious grouting products, do not use epoxy grouting products. Die Fugen nur mit Zementmörtel verfugen; keine Epoxid-Mörtel verwenden. Sceller les joints uniquement avec des mortiers de ciment, ne pas utiliser de mortiers époxydiques.
<b>PULIZIA ORDINARIA</b> ORDINARY CLEANING TÄGLICHE REINIGUNG NETTOYAGE QUOTIDIEN	<b>Utilizzare acqua o detersivi neutri comunemente in vendita presso i negozi. Per lo sporco ostinato utilizzare un qualunque detergente sgrassante purché non sia di alto valore alcalino. Non utilizzare mai alcool, acetone, solventi, candeggina, ammoniaca e prodotti alcalini o acidi di forte intensità. Non usare paste, spugne e spazzole abrasive.</b> Use water or neutral detergents normally available in stores. For more stubborn spots use any low-alkaline degreaser. Do not use alcohol, acetone, solvents, bleach, ammonia, and highly alkaline or highly acidic products. Do not use abrasive pastes, sponges, or brushes. Wasser oder neutrale im Handel erhältliche Reinigungsmittel verwenden. Bei stärkeren Verschmutzungen ein beliebiges fettlösendes Reinigungsmittel verwenden, sofern es keinen hohen alkalischen Wert hat. Niemals Alkohol, Aceton, Lösungsmittel, Bleichmittel, Ammoniak und alkalische Produkte oder starke Säuremittel verwenden. Keine Pasten, scheuernde Schwämme oder Bürsten einsetzen. Utiliser de l'eau ou des détergents neutres généralement en vente dans les magasins. Pour la saleté tenace, utiliser un détergent dégraissant quelconque dont la valeur alcaline n'est pas élevée. Ne jamais utiliser d'alcool, d'acétone, de solvants, d'eau de javel, d'ammoniaque, de produits alcalins ou d'acides à forte intensité. Ne pas utiliser de pâtes, d'éponges ou de brosses abrasives.
<b>TAGLIO E FORATURA</b> CUTTING AND DRILLING SCHNITT- UND BOHRARBEITEN DÉCOUPE ET PERÇAGE	<b>Per il taglio e la foratura è essenziale lavorare su una superficie planare e pulita. Eseguire il taglio solo con disco diamantato sottile sp. 1,2 mm (es: Tyrolit Premium DCT 1A1R) montato sulla guida della macchina da taglio (es: Kera-cut di Sigma) oppure a mano con smerigliatrice-flessibile. Eseguire i fori con trapano senza percussione con punta al tungsteno bagnandola ripetutamente con acqua. Per fori grandi utilizzare frese a tazza diamantate a fascia continua montate su smerigliatrice (flessibile).</b> For cutting and drilling it is essential to work on a flat, clean surface. To cut the material, use a 1.2 mm-thick diamond disk (ex. Tyrolit Premium DCT 1A1R) mounted on a cutting tool guide (ex. Kera-cut by Sigma) or by hand with a flexible-grinder. For drill use a non-hammer drill with a tungsten drill bit and wet it repeatedly with water. For large holes use a continuous crown diamond hole saw mounted on a grinder (flexible). Für das Schneiden und Bohren der Platte ist das Arbeiten auf einer ebenen und sauberen Oberfläche unerlässlich. Den Schnitt nur mit Hilfe einer dünnen auf der Führungsschiene der Schneidmaschine (z.Bsp. Kera-cut von Sigma) montierten Diamantscheibe (z.Bsp. Tyrolit Premium DCT 1A1R), Stärke 1,2 mm, oder mit einer Handschleifmaschine (Flex) ausführen. Die Bohrungen mit einem Normalbohrer (nicht Schlagbohrer) mit Tungsten-Spitze ausführen, die kontinuierlich mit Wasser benetzt wird. Für die großen Bohrungen auf Schleifmaschinen (Flex) montierte Diamant-Spiralfräser verwenden. Pour couper et percer, il est essentiel de travailler sur une surface plane et propre. Effectuer la coupe à l'aide d'un disque diamanté fin d'une épaisseur de 1,2 mm (ex: Tyrolit Premium DCT 1A1R) monté sur le guide de la machine de coupe (ex : Kera-cut de Sigma) ou à la main avec une meuleuse d'angle. Percer les trous à l'aide d'une perceuse sans percusion équipée d'un foret au tungstène, en la mouillant plusieurs fois avec de l'eau. Pour les trous plus grands, utiliser des trépan diamantés à bande continue montés sur des meuleuses d'angles.



# Informazioni per la posa

Laying information\_Informationen für die Verlegung\_Informations pour la pose

## Suggerimenti per la posa

Laying suggestions\_Empfehlungen für das Verlegen\_Conseils pour la pose

**È compito del posatore controllare sempre il materiale prima della posa. Stendere a terra alcune piastrelle (circa 3 mq) e verificarne accuratamente le specifiche tecniche ed estetiche d'insieme.**

The person in charge of installation must check all material before installing it. Place some tiles on the floor (approx. 3 m<sup>2</sup>) and check the overall technical and aesthetic characteristics with particular care.

### POSA

**Con collanti indicati per prodotti a bassa porosità.**

**Dopo aver effettuato la stuccatura, rimuovere in breve tempo con frequenti lavaggi di spugna ed acqua gli eccessi fino alla totale pulizia del pavimento. Successivamente fare lavaggio acido e alcalino come da istruzioni Panaria.**

**E' responsabilità del posatore provvedere sempre alla protezione della piastrellatura finita e pulita, prima della consegna al committente, tramite appositi materiali protettivi (es. pannelli in truciolare, fogli di cartone, ecc.).**

**Per la realizzazione di tagli interni e a «L» si consiglia di arrotondare i vertici dell'apertura utilizzando punte con diametro di almeno 5 mm, per ridurre il rischio di rottura o fessurazioni, nel materiale già posato.**

**È consigliabile posare il gres porcellanato Panaria utilizzando livellatori meccanici. Va però evidenziato che in commercio sono disponibili molteplici modelli, alcuni dei quali per le loro modalità di utilizzo, possono risultare non indicati per prodotti ceramici con particolari finiture. In caso di necessità si prega di contattare il Technical Department Panariagroup prima dell'installazione.**

**Per le indicazioni di posa di Zero.3 far riferimento al Manuale Tecnico Zero.3.**

### SOTTOFONDO

**Massetto cementizio.**

### DIMENSIONE FUGA

**2 mm per i prodotti rettificati e 4 mm per i prodotti non rettificati. Salvo diversa indicazione dei Codici di Posa Nazionali. La larghezza delle fughe deve comunque essere decisa dalla Direzione Lavori.**

### COLORE FUGA

**Grigio cemento o colore in tono con la piastrella.**

**Prima di usare stucchi colorati a grana fine su prodotti lappati, levigati o spazzolati fare sempre un test di prova. Se il pigmento colorato è molto tenace la rimozione potrebbe risultare molto difficoltosa.**

### LAYING

With adhesives for products with a low porosity.

After grouting, remove any excess product as quickly as possible by repeatedly washing the area with a sponge and water. Then perform acid washing, as instructed by Panaria.

It is the installer's responsibility to protect the finished and clean tiling before the delivery to the client, by using appropriate protective materials (e.g. chipboard, cardboard sheets, etc.).

To create interior and "L" cuts it is advisable to round off the tops of the opening using drill bits with a diameter of at least 5 mm to reduce the risk of breakage or cracks in the already laid material.

It is advisable to lay Panaria porcelain stoneware using mechanical levellers. However, it should be noted that many models are available on the market, some of which, due to their operating methods, may not be suitable for ceramic products with particular finishes. If necessary, please contact the Panariagroup Technical Department before installation.

For instructions on laying Zero.3, refer to the Zero.3 Technical Manual.

### SUBSTRATE

Compact cement bed.

### JOINT WIDTH

2 mm for rectified tiles and 4 mm for not ground tiles. The width of grout joints must be established by the installation supervisor, unless grout widths are regulated by national laying standards.

### GROUT COLOUR

Grey or matching the colour of the tile.

Before using fine-grain coloured grout on lapped, polished or brushed products, always perform a test. If the coloured pigment is very adhesive, it may be very difficult to remove.

Es ist Aufgabe des Fliesenlegers das Material vor der Verlegung stets zu kontrollieren. Einige Fliesen auf den Boden legen (circa 3 qm) und sorgfältig die spezifische ganzheitliche Technik und Ästhetik überprüfen.

Le poseur doit donc toujours contrôler le matériel avant la pose. Poser quelques carreaux (environ 3 m<sup>2</sup>) sur le sol sans les coller et en contrôler soigneusement les spécifications techniques et esthétiques générales.

### VERLEGUNG

Mit klebern für produkte mit geringer porosität.

Nach vorgenommener spachtelung schnell mit häufigem reinigen mit schwamm und wasser das überschüssige material bis zur vollständigen reinigung des fußbodens entfernen. Anschließend saures und alkalines nachspülen vornehmen, gemäß den vorgaben von Panaria.

Der Fliesenleger ist dafür zuständig, den fertig verlegten, sauberen Fliesenbelag vor der Übergabe an den Bauherrn mit geeigneten Schutzmaterialien (z.B. Spanplatten, Pappe etc.) abzudecken.

Für Innen- und „L“-Schnitte empfehlen wir, die Kanten der Öffnung mit Aufsätzen mit mindestens 5 mm Durchmesser abzurunden, um das Risiko von Bruchstellen oder Rissen im bereits verlegten Material zu verhindern.

Feinsteinzeug von Panaria sollte mithilfe von mechanischen Richtmaschinen verlegt werden. Es ist jedoch zu beachten, dass auf dem Markt eine Vielzahl von Modellen erhältlich ist. Einige davon könnten aufgrund der Art und Weise, wie sie verwendet werden, für Keramikprodukte mit speziellem Finish nicht geeignet sein. Bei Bedarf bitte vor dem Verlegen mit der Technischen Abteilung von Panariagroup Rücksprache halten.

Für Anweisungen zum Verlegen von Zero.3 bitte im Technischen Handbuch von Zero.3 nachlesen.

### UNTERGRUND

Kompakter Zementestrich.

### FUGENBREITE

2 mm für geschliffene Platten und 4 mm für ungeschliffene Platten. Sofern in den Nationalen Verlegungsstandards nicht anders angegeben, ist die Breite der Fugen von der Bauleitung zu bestimmen.

### FUGENFARBE

Grau oder auf die Fliesenfarbe abgestimmt.

Bevor farbige fugenfüller mit feiner körnung auf geläpften, gehonten und gebürsteten produkten eingesetzt werden ist stets eine probeanwendung erforderlich. Wenn das farbpigment sehr resistent ist, könnte der fugenfüller sehr schwer zu entfernen sein.

### POSE

Avec des colles adaptées aux produits à faible porosité.

Après avoir effectué le stucage, éliminer rapidement les excès par des lavages fréquents avec une éponge et de l'eau jusqu'à ce que le sol soit complètement propre. Effectuer ensuite le lavage acide et alcalin selon les instructions fournies par Panaria.

Il incombe au carreleur de protéger le dallage fini et propre avant la livraison au client, en utilisant des matériaux de protection appropriés (e.g. panneau aggloméré, feuille de carton etc.).

Sous-couche: lit de ciment compact. Pour réaliser des découpes internes en « L » nous conseillons d'arrondir les sommets de l'ouverture avec des forets de 5mm de diamètre minimum, afin de réduire le risque de rupture ou de fissure du matériau déjà en place.

Nous conseillons de poser le grès cérame Panaria en utilisant des niveleuses mécaniques. Nous faisons remarquer qu'il existe dans le commerce plusieurs modèles, dont certains peuvent, à cause de leur mode d'emploi, ne pas être indiqués pour les produits en céramique ayant des finitions particulières. En cas de besoin veuillez contacter le Service technique de Panariagroup avant de procéder à l'installation. Pour les indications de pose de Zero.3 consultez le Manuel technique de Zero.3.

### SOUS-COUCHE

Lit de ciment compact.

### DIMENSION JOINT

2 mm pour les carreaux rectifiés et 4 mm pour les carreaux pas rectifiés. Sauf indication contraire contenue dans les Normes de Pose Nationaux, la dimension des joints doit en tous cas être définie par le directeur des travaux.

### COULEUR JOINT

Ciment griso ou dans la teinte du carreau.

Toujours effectuer un test avant d'utiliser des stucs colores a granulometrie fine sur des produits ponces, polis et brosses. L'elimination d'un pigment tres prononce pourrait s'averer difficile.



FUGA MINIMA CONSIGLIATA<sup>(\*\*)</sup>  
RECOMMENDED MINIMUM JOINT<sup>(\*\*)</sup>  
MINIMALE EMPFOHLENE FUGE<sup>(\*\*)</sup>  
JOINT MINIMUM CONSEILLÉ<sup>(\*\*)</sup>

RECT (INTERNO / INDOOR / INNEN / INTÉRIEUR)

2 mm

NOT RECT (INTERNO / INDOOR / INNEN / INTÉRIEUR)

3-4 mm circa / approx. / z.ka / environs

ESTERNO / OUTDOOR / AUSSEN / EXTÉRIEUR

5-6 mm circa / approx. / z.ka / environs

**(\*\*) Salvo diversa indicazione dei Codici di Posa Nazionali. La larghezza delle fughe deve comunque essere decisa dalla Direzione Lavori.** The width of grout joints must be established by the installation supervisor, unless grout widths are regulated by national laying standards. Ausgenommen eigene gesetzlichen Verlege- Regelungen. Die Breite der Fuge muss von der Bauleitung entschieden werden. Sauf indication différente du DTU. La dimension des joints doit être, de toute façon, décidé par le responsable du chantier.



# Tabelle calibri

Size table\_Formattabellen\_Tableaux des calibres

## FUGA MINIMA CONSIGLIATA 2 mm\_RECOMMENDED MINIMUM JOINT 2 mm\_MINIMALE EMPFOHLENE FUGE 2 mm\_JOINT MINIMUM CONSEILLÉ 2 mm

CALIBRO CALIBRE KALIBER CALIBRE	30x30 RECT		40x60 RECT		30x60 RECT		60x60 RECT		40x120 RECT		60x120 RECT		20x120 RECT		30x120 RECT		45x90 RECT	
<b>O</b>	299,0	299,0	399,3	600,0	299,0	600,0	600,0	600,0	399,3	1202,0	600,0	1202,0	198,7	1202,0	299,0	1202,0	449,5	901,0
<b>P</b>	298,0	298,0	398,0	598,0	298,0	598,0	598,0	598,0	398,0	1198,0	598,0	1198,0	198,0	1198,0	298,0	1198,0	448,0	898,0
<b>Q</b>	297,0	297,0	396,7	596,0	297,0	596,0	596,0	596,0	396,7	1195,0	596,0	1195,0	197,0	1195,0	297,0	1195,0	446,5	895,0
<b>R</b>	296,0	296,0	395,3	595,0	296,0	595,0	595,0	595,0	395,3	1192,0	595,0	1192,0					445,0	445,0

CALIBRO CALIBRE KALIBER CALIBRE	45x90 RECT		60x90 RECT		90x90 RECT		20x180 RECT		30x180 RECT		88x88 RECT							
<b>O</b>	449,5	901,0	599,0	901,0	901,0	901,0	198,7	1803,0	298,0	1803,0	881,0	881,0						
<b>P</b>	448,0	898,0	598,0	898,0	898,0	898,0	198,0	1799,0	297,0	1799,0	878,0	878,0						
<b>Q</b>	446,5	895,0	596,0	895,0	895,0	895,0	197,0	1795,0	296,0	1795,0	875,0	875,0						

## FUGA MINIMA CONSIGLIATA 3 mm\_RECOMMENDED MINIMUM JOINT 3 mm\_MINIMALE EMPFOHLENE FUGE 3 mm\_JOINT MINIMUM CONSEILLÉ 3 mm

CALIBRO CALIBRE KALIBER CALIBRE	30x60,3 NAT	60,3x60,3 NAT
<b>F</b>	297,6x598,2	598,2x598,2
<b>G</b>	298,8x600,6	600,6x600,6
<b>J</b>	300,0x603,0	603,0x603,0
<b>K</b>	301,2x605,4	605,4x605,4
<b>Y</b>	302,4x607,8	607,8x607,8

## FUGA MINIMA CONSIGLIATA 4 mm\_RECOMMENDED MINIMUM JOINT 4 mm\_MINIMALE EMPFOHLENE FUGE 4 mm\_JOINT MINIMUM CONSEILLÉ 4 mm

CALIBRO CALIBRE KALIBER CALIBRE	20,0x90,5 NAT	20,0x121,5 NAT
<b>M</b>	198,0 x 899,0	198,0 x 1201,0
<b>Q</b>	198,4 x 900,8	198,4 x 1203,4
<b>S</b>	198,8 x 902,6	198,8 x 1205,8
<b>T</b>	199,2 x 904,4	199,2 x 1208,2
<b>X</b>	199,6 x 906,2	199,6 x 1210,6
<b>U</b>	200,0 x 908,0	200,0 x 1213,0
<b>A</b>	200,4x909,8	200,4 x 1215,4

## FUGA MINIMA CONSIGLIATA 4 mm\_RECOMMENDED MINIMUM JOINT 4 mm\_MINIMALE EMPFOHLENE FUGE 4 mm\_JOINT MINIMUM CONSEILLÉ 4 mm (Petra Solis)

CALIBRO CALIBRE KALIBER CALIBRE	20,0x20,0 NAT	20,0x40,4 NAT	40,4x40,4 NAT	40,4x60,8 NAT	60,8x60,8 NAT
<b>I</b>	197,6x197,6	197,6x399,2	399,2x399,2	399,2x600,8	600,8x600,8
<b>Q</b>	198,4x198,4	198,4x400,8	400,8x400,8	400,8x603,2	603,2x603,2
<b>T</b>	199,2x199,2	199,2x402,4	402,4x402,4	402,4x605,6	605,6x605,6
<b>U</b>	200,0x200,0	200,0x404,0	404,0x404,0	404,0x608,0	608,0x608,0
<b>V</b>	200,8x200,8	200,8x405,6	405,6x405,6	405,6x610,4	610,4x610,4

## FUGA MINIMA CONSIGLIATA 10 mm\_RECOMMENDED MINIMUM JOINT 10 mm\_MINIMALE EMPFOHLENE FUGE 10 mm\_JOINT MINIMUM CONSEILLÉ 10 mm (Bioarch - Pietre di Fanes)

CALIBRO CALIBRE KALIBER CALIBRE	20,0x20,0 NAT	20x30,5 NAT	20x41 NAT
<b>B</b>	197,6x197,6	197,6x301,4	197,6x405,2
<b>E</b>	200,0x200,0	200,0x305,0	200,0x410,0
<b>M</b>	202,4x202,4	202,4x308,6	202,4x414,8

## FUGA MINIMA CONSIGLIATA 10 mm\_RECOMMENDED MINIMUM JOINT 10 mm\_MINIMALE EMPFOHLENE FUGE 10 mm\_JOINT MINIMUM CONSEILLÉ 10 mm (Pierre des Reves)

CALIBRO CALIBRE KALIBER CALIBRE	20,0x20,0 NAT	20x30,2 NAT	20x40,4 NAT
<b>I</b>	197,6x197,6	197,6x298,4	197,6x399,2
<b>Q</b>	198,4x198,4	198,4x299,6	198,4x400,8
<b>T</b>	199,2x199,2	199,2x300,8	199,2x402,4
<b>U</b>	200,0x200,0	200,0x302,0	200,0x404,0
<b>V</b>	200,8x200,8	200,8x303,2	200,8x405,6
<b>W</b>	201,6x201,6	201,6x304,4	201,6x407,2
<b>Y</b>	202,4x202,4	202,4x305,6	202,4x408,8

## Zero.3 SPESSORE 5,5 mm\_THICKNESS 5,5 mm\_STÄRKE 5,5 mm\_EPAISSEUR 5,5 mm

CALIBRO CALIBRE KALIBER CALIBRE	50x100		100x100		100x250		100x300	
<b>F</b>	497	997	997	997	997	2500	997	3000

## Zero.3 SPESSORE 6 mm\_THICKNESS 6 mm\_STÄRKE 6 mm\_EPAISSEUR 6 mm

CALIBRO CALIBRE KALIBER CALIBRE	60x120		120x120		120x260		120x278	
<b>P</b>	598	1198	1198	1198	1198	2600	1198	2780

# Pulizia

Cleaning\_Reinigung\_Nettoyage

## Pulizia stucchi cementizi miscelati con acqua

Cleaning cement-based grouts mixed with water\_Reinigung des mit wasser Angemischten zementmörtels\_Nettoyage des enduits de ciments mélangés à de l'eau

### PULIZIA “DOPOPOSA”

**La pulizia “dopoposa” serve per rimuovere i residui di stucchi per le fughe, cemento, calce, boiaccia. È obbligatoria a fine cantiere, sia per le piastrelle smaltate che per quelle non smaltate. Effettuare la pulizia dopo 4-5 giorni dalla stuccatura (lo stucco deve indurire) e non oltre 10 giorni. Oltre questi tempi la pulizia può diventare molto più laboriosa.**

### Superfici antiscivolo

**Per loro peculiarità, le superfici antiscivolo, ruvide o strutturate si puliscono più laboriosamente. Si consiglia perciò di prestare particolare attenzione alle modalità di pulizia, in particolare intervenendo rapidamente ed utilizzando monospazzola con dischi bianchi e beige.**

### CLEANING AFTER LAYING

Cleaning after laying is done to remove residues of joint fillers, cement, lime or grout. It is essential to do it at the end of the job, both for glazed and for unglazed tiles. Carry out cleaning 4-5 days after grouting (the grout needs to harden) and not later than 10 days after grouting. Any later than this, and cleaning can become very laborious.

### Anti-slip surfaces

Due to their special features, rough or structured anti-slip surfaces are harder to clean. It is thus recommended to be very careful while cleaning, above all intervening quickly and using a single brush with white or beige disks.

### REINIGUNG NACH DEM VERLEGEN

Die Reinigung nach dem Verlegen dient dazu, die Reste des Fugenmörtels, des Betons, des Kalks und der Zementmasse von den Fliesen zu entfernen. Die Reinigung muss sofort nach Beendigung der Arbeiten erfolgen. Dies gilt sowohl für glasierte als auch für unglasierte Fliesen. Die Fliesen 4-5 Tage, spätestens aber 10 Tage nach dem Verputzen reinigen (der Putz muss erhärten). Nach diesem Zeitraum kann die Reinigung einen sehr viel höheren Arbeitsaufwand erforderlich machen.

### Rutschfeste oberflächen

Aufgrund ihrer Beschaffenheit sind die rutschfesten, rauen oder strukturierten Oberflächen etwas schwieriger zu reinigen. Aus diesem Grunde ist die Reinigung sehr wichtig. Für eine schnellere Reinigung wird der Einsatz einer Einscheibenmaschine mit einer weissen oder beige Scheibe empfohlen.

### NETTOYAGE APRÈS LA POSE

Le nettoyage après la pose permet de retirer les résidus de ciment derejointoement, de ciment, de plâtre et de coulis. Il est obligatoire en fin de chantier pour les carrelages émaillés ou non. Procéder au nettoyage 4 à 5 jours après le rejointoement (le matériau doit durcir) et en tout cas avant 10 jours. Après ce délai, le nettoyage risque d'être beaucoup plus difficile.

### Surfaces antiderapantes

Du fait de leurs caractéristiques spécifiques, les surfaces antidérapantes (rugueuses ou structurées) demandent des opérations de nettoyage plus complexes. Il est donc conseillé de suivre minutieusement les instructions de nettoyage, de veiller à réduire le plus possible les temps d'intervention et d'utiliser une monobrosse avec des disques blancs ou beiges.

TIPO DI DETERGENTE TYPE OF DETERGENT REINIGUNGSMITTEL ART TYPE DE DÉTERGENT	NOME DETERGENTI NAME OF DETERGENT REINIGUNGSMITTEL NOM DU DÉTERGENT	PRODUTTORE MANUFACTURER HERSTELLER FABRICANT
A base acida Acid-based Auf säurebasis À base acide	SOLVACID (*) CEMENT REMOVER (*) DETERDEK PRO (*) KERANET (*) TREK (*) ZEMENTSCHLEIERENTFERNER (*) HMK R63 (*) BONACLEAN / BCLEAN (*)	GEAL FABERCHIMICA FILA MAPEI KITER LITHOFIN HMK
	BONADECAN / BDECON (*) Specifico per prodotti non resistenti agli acidi Specific for products not resistant to acids Für nicht säurebeständige Produkte geeignet Spécifique pour produits pas résistant aux acides	BONASYSTEMS ITALIA

**(\*) Seguire attentamente le modalità d'uso indicate sulle confezioni dai fabbricanti. Fare sempre test preventivo sulle piastrelle prima dell'uso, in particolare su prodotti Lappati o Levigati.**

(\*) Follow the manufacturer's instruction closely. Always do a test in advance on the tiles before use, particularly on Lapped or polished products.

(\*) Aufmerksam die Anweisungen der Hersteller befolgen. Vor der Benutzung sollten Sie immer erst einen prophylaktischen Probeauftrag durchführen, besonders auf geläpften oder polierten Fliesen.

(\*) Suivre attentivement les indications des fabricants. Toujours procéder à un essai sur les carreaux avant l'utilisation, surtout pour les articles rodés ou polis.

## Pulizia stucchi epossidici, bi-componenti e reattivi

Cleaning for epoxy, bi-component and reagent grouts\_Reinigung von Epoxi-, bi-komponent und aktiven Spachtelmassen\_Nettoyage des joints Epoxy, bi-composant et réactif

**La rimozione di questi stucchi deve essere fatta immediatamente ed in modo accurato perché questi stucchi induriscono molto rapidamente, anche in pochi minuti.**

**Seguire attentamente le modalità di pulizia indicate dal fabbricante dello stucco utilizzato e verificarne l'efficacia (anche controluce) con una prova preliminare di pulizia prima di stuccare l'intero pavimento/parete.**

Removal of the residues of these grouts must be carried out immediately and thoroughly, as these grouts harden very rapidly, even in a few minutes. Please carefully follow the cleaning mode specified by the manufacturer of the grout used; verify its effectiveness (backlight also) with a preliminary cleaning test before grouting the entire floor/wall.

Die Reste dieser Mörtelarten müssen sofort nach dem Verlegen sorgfältig entfernt werden, da sie extrem schnell (in wenigen Minuten) erhärten.

Die angegebene Reinigungshinweis vom Hersteller der verwendete Fugenmasse sorgfältig befolgen. Vor dem Verfugen des gesamten Belag (Boden u/o Wand), die Wirkung der Reinigungsempfehlung (auch im Gegenlicht) mit einem Vor-Test Reinigung überprüfen.

Le nettoyage des résidus doit être effectué immédiatement et avec soin, car ce type de matériau durcit très rapidement (en quelques minutes).

Suivez attentivement les indications de nettoyage indiqué par le fabricant de joint utilisé et vérifiez son efficacité (même rétro-éclairage) avec un nettoyage préventif avant de jointoyer la totalité du sol/mur.

## Protettivi per fughe

Stain resistant products for joints\_Fugenschutzmittel\_Protection joints

**Servono per ridurre la porosità e quindi la macchiabilità delle fughe cementizie. L'applicazione di questi protettivi ne migliora anche la pulibilità.**

In order to reduce absorption and stain. The application of these products improves cleaning as well.

Folgende Mitteln reduzieren die Porosität der Fugen und daher erhöhen die Fleckenbeständigkeit der Fugen. Die Anwendung dieser Schützmitteln verbessern auch die Reinigung.

Ils servent afin de réduire la porosité et donc la tachabilité des joints en ciment. L'application des ces produits améliore aussi l'entretien.

### Seguire attentamente le modalità d'uso indicate sulle confezioni dai fabbricanti

Follow the manufacturer's instruction closely

Aufmerksam die Anweisungen der Hersteller befolgen

Suivre attentivement les indications des fabricants

NOME PRODOTTO NAME OF PRODUCT PRODUKTNAME NOM DU PRODUIT	PRODUTTORE MANUFACTURER HERSTELLER FABRICANT
FUGAPROOF	FILA
KF FUGENSCHUTZ	LITHOFIN

# Pulizia

Cleaning\_Reinigung\_Nettoyage

## Pulizia quotidiana

Routine cleaning\_Tägliche Reinigung\_Nettoyage quotidien

**Utilizzare acqua calda e un panno in microfibra di buona qualità, tipo MAGIC CLEAN di Bonasystems Italia. Al bisogno utilizzare acqua calda e detergente neutro molto diluito (un tappo del flacone in 5 lt di acqua) o acqua calda e sgrassatore universale (4-5 spruzzate in 5 lt di acqua). A fine lavaggio risciacquare sempre con acqua e panno in microfibra pulito. Si consigliano i seguenti prodotti reperibili in commercio.**

Use warm water and a high quality microfibre cloth, like MAGIC CLEAN by Bonasystems Italia. If needed, use warm water and a very diluted neutral detergent (one cap in 5 litres of water) or warm water and a universal degreaser (4-5 sprays in 5 litres of water). When finished washing, always rinse with water and a clean microfibre cloth. We recommend the following products which are available on the market.

Warmes Wasser und ein hochwertiges Mikrofaserstuch wie MAGIC CLEAN von Bonasystems Italia verwenden. Bei Bedarf Warmwasser und ein stark verdünntes, neutrales Reinigungsmittel verwenden (ein Flaschenverschluss auf 5 l Wasser) oder warmes Wasser und einen Universal-Entfetter (4-5 Sprühstöße auf 5 l Wasser). Nach dem Reinigen stets mit einem zweiten hochwertigen Mikrofaserstuch und klarem Wasser nachwischen. Es wird empfohlen, folgende im Handel erhältlichen Produkte zu verwenden.

Utiliser de l'eau chaude et un chiffon en microfibre de bonne qualité, comme les chiffons MAGIC CLEAN de Bonasystems Italia. Si besoin, utiliser de l'eau chaude et un détergent neutre très dilué (un bouchon pour 5 l d'eau) ou de l'eau chaude et un dégraissant universel (4 à 5 pulvérisations pour 5 l d'eau). Après chaque lavage, toujours rincer avec de l'eau et un chiffon en microfibre propre. Ces produits sont disponibles dans le commerce.

TIPO DI DETERGENTE TYPE OF DETERGENT REINIGUNGSMITTEL ART TYPE DE DÉTERGENT	NOME DETERGENTI NAME OF DETERGENT REINIGUNGSMITTEL NOM DU DÉTERGENT	PRODUTTORE MANUFACTURER HERSTELLER FABRICANT	TIPO DI MICROFIBRA TYPE OF MICRO-FIBER MICRO-FASER ART TYPE DE MICROFIBRA
Neutro Neutral Neutral Reiniger Neutre	FLOOR CLEANER CLEANER PRO BELGRES	FABERCHIMICA FILEA GEAL	MAGICCLEAN / BMAGICCLEAN (BONASYSTEMS ITALIA) o similari or like products oder ähnliche Produkte ou produits similaires
Sgrassatore universale Universal degreaser Universal-Entfetter Dégraissant universel	BONAMAIN + / BMAIN + BONATITANIA CLEAN / BTITANIA CLEAN PFLEGEREINIGER HMK P15 CHANTECLAIR SGRASSATORE UNIVERSALE SMAC EXPRESSE SGRASSATORE	BONASYSTEMS ITALIA BONASYSTEMS ITALIA LITHOFIN HMK REAL CHIMICA BOLTON GROUP	

## Pulizia straordinaria

Non-routine cleaning\_Außerplanmäßige Reinigung\_Nettoyage extraordinaire

TIPO DI SPORCO TYPE OF DIRT SCHMUTZART TYPE DE SALETÉ	TIPO DI DETERGENTE TYPE OF DETERGENT REINIGUNGSMITTEL ART TYPE DE DÉTERGENT	NOME DETERGENTI NAME OF DETERGENT REINIGUNGSMITTEL NOM DU DÉTERGENT	PRODUTTORE MANUFACTURER HERSTELLER FABRICANT
Caffè, coca cola, succhi di frutta Coffee, coca-cola, fruit juice Kaffee, coca cola, fruchtsäfte Café, coca-cola, jus de fruits	POLIFUNZIONALI, A BASE ALCALINA <sup>(1)</sup> Multipurpose, alkaline based <sup>(1)</sup> Polyfunktionell, mit alkalibasis <sup>(1)</sup> Alcalins universels <sup>(1)</sup>	COLOURED STAIN REMOVER PS87 PRO SUPER DETERJET CANDEGGINA Bleach Bleichmittel Eau de Javel	FABERCHIMICA FILEA GEAL VARI PRODUTTORI Various manufactures Verschiedene hersteller Fabricants divers
Grassi, polvere da calpestio, pulizie di fondo Grease, dust footmarks, base cleaning Fette, trittstaub, grundreinigung Graises, dépôts de poussières, grands nettoyages	POLIFUNZIONALI, A BASE ALCALINA <sup>(1)</sup> Multipurpose, alkaline based <sup>(1)</sup> Polyfunktionell, mit alkalibasis <sup>(1)</sup> Alcalins universels <sup>(1)</sup>	PS87 PRO DETERFLASH INTENSIVREINIGER HMK R55 TASKI R20-STRIP BONADECOR / BDECOR	FILEA GEAL LITHOFIN HMK JOHNSONDIVERSEY BONASYSTEMS ITALIA
Vino Wine Wein Vin	OSSIDANTE Oxidising Oxidationsmittel Oxydant	OXIDANT CANDEGGINA Bleach Bleichmittel Eau de Javel	FABERCHIMICA VARI PRODUTTORI Various manufactures Verschiedene hersteller Fabricants divers
Depositi calcare Deposits of lime Kalkablagerungen Dépôts de calcaire	A BASE ACIDA <sup>(1)</sup> Acid-based <sup>(1)</sup> Auf säurebasis <sup>(1)</sup> À base acide <sup>(1)</sup>	VIAKAL	PROCTER & GAMBLE
Ruggine Rust Rost Rouille	A BASE ACIDA <sup>(1)</sup> Acid-based <sup>(1)</sup> Auf säurebasis <sup>(1)</sup> À base acide <sup>(1)</sup>	ACIDO MURIATICO DILUITO Dilute hydrochloric acid Verdünnte salzsäure Acide muriatique diluée	VARI PRODUTTORI Various manufactures Verschiedene hersteller Fabricants divers
Pneumatici, segni di matita, segni metallici Tyre marks, pencil marks, metallic marks Reifenschmutz, bleistift- und metallische rückstände Pneumatiques, traces de crayon, traces métalliques	PASTA ABRASIVA <sup>(1)</sup> Abrasive paste <sup>(1)</sup> Scheuermittel <sup>(1)</sup> Pâte abrasive <sup>(1)</sup>	POLISHING CREAM <sup>(2)</sup> DETERGUM <sup>(2)</sup> VIM CLOREX <sup>(2)</sup> STRONG REMOVER <sup>(2)</sup>	FABERCHIMICA ZEP ITALIA GUABER FABERCHIMICA
Inchiostri, pennarello Ink, marker pens Tinte, filzstift Encres, marqueurs	A BASE SOLVENTE Solvent-based Auf lösungsmittelbasis À base de solvant	DILUENTE NITRO, ACQUA RAGIA Nitrous thinners, white spirit Nitroverdünnungsmittel, acqua ragia Diluant nitrocellulosique, white spirit COLOURED STAIN REMOVER	VARI PRODUTTORI Various manufactures Verschiedene hersteller Fabricants divers FABERCHIMICA
Sporco sulle fughe Tile joint stains Fugenschmutz Saleté des joints	SPECIFICO Specific Spezifisch Spécifique	FUGANET FUGENREINIGER	FILEA LITHOFIN

**Modalità d'uso: seguire le indicazioni dei fabbricanti**\_Method of use: follow the manufacturer's instructions\_Gebrauchsanleitung: Die Angaben der Hersteller befolgen\_  
Mode d'emploi: suivre attentivement les indications des fabricants

**(1) Fare sempre test preventivo su materiali Lappati e Levigati**\_Always do a test in advance on lapped or polished tiles\_Von der Benutzung immer erst einen Probeauftrag durchführen, besonders auf geläpften u. polierten Fliesen\_Toujours procéder à un essai sur les carreaux rodés ou polis

**(2) Usare con molta attenzione sui materiali Lappati e Levigati**\_Exercise extreme caution when using on Lapped and polished materials\_Auf geläpftem und poliertem Material mit besonderer Vorsicht verwenden\_Utiliser avec précaution sur les matériaux Polis et Rodés

**(3) Non usare su prodotti Lappati, usare con molta attenzione sui Levigati**\_Do not use on lapped products, and use with great care on polished products\_Nicht zum Reinigen geläpfter Produkte und nur sehr vorsichtig bei geschliffenen Oberflächen benutzen\_Ne pas utiliser sur des articles Rodés, utiliser avec prodence sur les articles Polis

**NON** utilizzare cere su piastrelle Panaria.  
**DON'T USE** wax on Panaria tiles.

**KEINE** Wachse auf Fliesen von Panaria verwenden.  
**NE UTILISER PAS** des cires sur les carreaux Panaria.

## Rimozione di cere o patine lucidanti

Removing waxes or glossy coatings\_Das Entfernen von Wachs und glänzender Patina\_Retrait de cire ou de patine brillante

**Non seguire le indicazioni sulla confezione, ma applicare il detergente puro, lasciare agire per 5-10 minuti, frizionare con tamponi morbidi (bianco, giallo) e sciacquare bene con acqua.**

Do not follow the instructions on the packaging, but apply the detergent neat, leave to act for 5-10 minutes, rub with a soft pad (white, yellow) and rinse well with water.

In diesem Fall dürfen die Anweisungen auf der Verpackung NICHT befolgt werden. Der Reiniger muss unverdünnt aufgetragen werden und 5-10 Minuten lang einwirken. Danach mit einem weichen Pad einreiben (weiß, gelb) und gründlich mit Wasser abspülen.

Ne pas suivre les indications figurant sur l'emballage. Appliquer le détergent pur. Laisser agir pendant 5 à 10 minutes. Frotter à l'aide d'un chiffon doux (blanc, jaune) et bien rincer à l'eau claire.

TIPO DI DETERGENTE TYPE OF DETERGENT REINIGUNGSMITTEL ART TYPE DE DÉTERGENT	NOME DETERGENTE NAME OF DETERGENT REINIGUNGSMITTEL NOM DU DÉTERGENT	PRODUTTORE MANUFACTURER HERSTELLER FABRICANT
Specifico Specific Spezifisch Spécifique	TILE CLEANER (*) Puro Neat Puro Pur	FABERCHIMICA

\* Prima della pulizia fare sempre test preventivo\_Before cleaning always do a test in advance\_Vor dem Reinigungsverfahren, Probetest durchführen\_Avant le nettoyage procéder toujours à un essai sur les carreaux

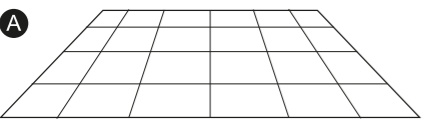
**A**  **Pavimento originale.**  
Original floor  
Originalfußboden  
Sol original

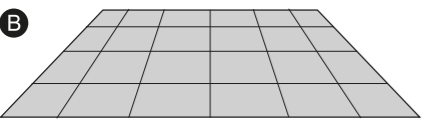
**B**  **Dopo pulizia con detergenti che depositano patine lucide o dopo stuccatura con alcuni stucchi per le fughe.**  
After cleaning using detergents which leave a glossy finish, or after applying some products for joints.  
Nach der Verwendung von Reinigungsmitteln, die einen glänzenden Film hinterlassen, bzw. nach dem Verfugen mit einigen Fugmassen.  
Après nettoyage avec des détergents qui laissent une couche brillante ou après cimentage avec certains coulis pour joints.

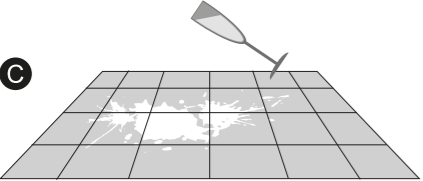
**C**  **Semplici alimenti (Coca-Cola, vino, acqua...) possono togliere la patina lucida. La superficie originale è più opaca.**  
Simple foodstuffs (coca-cola, wine, water etc.) can remove the bright patina. The original surface is more matt.  
Normale Lebensmittel (Coca-Cola, Wein, Wasser usw...) können die glänzende Patina entfernen. Die Originaloberfläche ist matter.  
Certains aliments (Coca-Cola, vin, eau, etc.) peuvent enlever la patine brillante. La surface originelle est plus opaque.

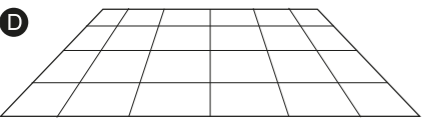
**D**  **Rimuovere la patina con detergente idoneo con panno in microfibra ed effettuare la pulizia quotidiana come indicato in questa brochure nell'apposita sezione.**  
Remove the patina with a suitable detergent using a micro-fiber cloth, and carry out the everyday cleaning as per the indications in the appropriate section of this brochure.  
Die Patina sollte mit geeigneten Reinigungsmittel entfernt werden mit einem Tuch aus Micro-Faser und die tägliche Reinigung sollte, verwendet werden wie in der passenden Abschnitt dieser Brochüre empfohlen.  
Retirer la patine à l'aide d'un détergent approprié avec une serpillière en microfibre et effectuer le nettoyage quotidien comme indiqué dans la section appropriée de cette brochure.

## Pulizia dei decori

Cleaning decorations\_Reinigung des Fliesendekors\_Nettoyage décors

**Utilizzare detergenti neutri e diluiti. NON UTILIZZARE detergenti acidi, alcalini, ceranti e/o impregnanti, abrasivi o pagliette abrasive o di metallo.**

Use neutral and diluted detergents.  
NEVER USE acid or alkaline detergents, abrasive pastes, abrasive brushes or sponges.

Verwenden Sie ausschließlich neutral und verdünnte Reinigungsmittel. VERWENDEN SIE AUF KEINEN FALL: Ätzende oder alkalische Reinigungsmittel, Scheuerpasten und Pulver, Grobe Bürsten oder abrasive Schwämme.

Utiliser des détergents neutres et dilués.  
NE SURTOUT PAS utiliser des détergents acides ou alcalins, des produits abrasifs, des brosses ou des éponges abrasives.

## Trattamenti Antislip

Anti-slip treatments\_Anti-Rutsch-Behandlung\_Traitement antidérapant

**La resistenza allo scivolamento dei pavimenti posati (sia piastrelle smaltate che non smaltate) può essere aumentata utilizzando specifici prodotti (vedi tabella). Prima di applicare il prodotto sul pavimento fare test preventivi su piastrelle non posate per trovare i tempi di contatto più idonei. Se da un lato tempi più lunghi aumentano il grado di grip, dall'altro tendono un po' a sbiancare i colori delle piastrelle e a renderle un pochino più sporcabili. Trattandosi di una applicazione molto tecnica, prima di eseguire qualsiasi prova contattare la ditta Bonasystems Italia.**

The resistance of laid floor-tiles (both glazed and unglazed) to slipping can be increased by using specific products: see table. Before applying the product to the floor, do an advance test on unglazed tiles to find the most suitable contact times. On the one hand, longer contact times increase the level of grip, but on the other hand they tend to whiten the colours of the tiles and make them attract dirt a little more. Before doing any test please contact Bonasystems Italia company, since this is a very technical application.

Der Gleitwiderstand auf den verlegten Bodenbelägen (sowohl glasierte als auch unglasierte Fliesen) kann mithilfe von entsprechenden Produkten (siehe Tabelle) erhöht werden. Vor dem Auftragen des Produktes auf den Boden empfiehlt es sich, einen Test auf einer noch nicht verlegten Fliese durchzuführen, um so die geeignete Kontaktzeit bestimmen zu können. Während einerseits die Haftfähigkeit durch verlängerte Kontaktzeiten erhöht wird, werden andererseits die Farben der Fliesen ein wenig gebleicht, wodurch diese etwas leichter verschmutzen. Aufgrund von der erhöhten technische Schwierigkeit, vor jedem Probetest oder Benutzung, setzen Sie sich mit der Fa. Bonasystems Italia in Verbindung.

La résistance des produits antidérapants posés peut être améliorée (carrelage émaillé ou non) à l'aide de produits spécifiques (voir tableau). Avant d'appliquer le produit sur le carrelage, faire un essai sur un carreau non posé afin de déterminer la durée de contact la mieux adaptée. Si des durées plus importantes augmentent l'adhérence, elles décolorent aussi les carreaux et les rendent plus salissants. Avant d'effectuer tout test veuillez contacter la société Bonasystems Italia, puisque il s'agit d'une application très technique.

NOME PRODOTTO_NAME OF PRODUCT PRODUKTNAME_NOM DU PRODUIT	PRODUTTORE_MANUFACTURER HERSTELLER_FABRICANT
BONAGRIP	BONASYSTEMS ITALIA

RIFERIMENTI UTILI_USEFUL REFERENCES_NÜTZLICHE LINKS_RÉFÉRENCES UTILES		
<b>MAPEI SpA</b> via Cafiero 2 20158 Milano - ITALY Tel. +39 02 37673 www.mapei.it	<b>JOHNSONDIVERSEY</b> via Meucci, 40 20128 Milano - ITALY Tel. +39 0373 2051 www.johnsondiversey.com	<b>LITHOFIN-Produkte</b> GmbH, Postfach 1134, D-73236 Wendlingen (D) Service - Tel. 0049 07024/940320 www.lithofin.de Vertrieb für Österreich: CT-Austria Ges.m.b.H. A-1230 Wien Tel. 0043 01 8673434
<b>FABERCHIMICA Srl</b> via G. Ceresani 10 Loc. Campo d'Olmo - 60044 Fabriano (AN) - ITALY Tel. +39 0732 627178 www.faberchimica.com	<b>BONASYSTEMS ITALIA SRL</b> via Borgo S.Chiera, 29 30020 Torre di Mosto (VE) - ITALY Tel. +39 0421 325691, Fax +39 0421 324232 www.bonasystemsitatia.it	<b>HMK - MÖLLER-CHEMIE</b> Benelux GmbH Linge 4 NL-2105 WB Heemstede (NL) Tel. 0031 0252-220222 www.moellerchemie.de
<b>FILA Industria Chimica SpA</b> via Garibaldi 32 - 35018 S. Martino dei Lupari (PD) - ITALY Tel. +39 049 9467300 www.filachim.it	<b>KITER Srl</b> via Assiano 7/B - 20019 Settimo Milanese (MI) - ITALY Tel. +39 02 3285220 www.kiter.it	<b>FEDERCHEMICALS Srl</b> Via G. Borsi, 2 - 25128 - Brescia - Italy Tel. +39 030 3390880, Fax +39 030 3385580 www.federchemicals.it
<b>ZEP Italia Srl</b> via Nettunese Km 25,000 - 04011 Aprilia (LT) - ITALY Tel. +39 06 926691 www.zepitalia.it	<b>GEAL Srl</b> via Settola 121 - 51031 Agliana (PT) - ITALY Tel. +39 0574 750365 www.geal-gres.it	

# Panaria e l'ambiente

Panaria and the environment\_Panaria und die Umwelt\_Panaria et l'environnement

## L'impegno per la salvaguardia dell'ambiente

The commitment to protecting the environment\_Engagement Für Umweltschutz\_Engagement à préserver l'environnement

### CERTIFICAZIONI AMBIENTALI ISO 14001, EMAS ed EPD

**Gli stabilimenti produttivi Panaria possiedono Sistemi di Gestione Ambientale certificati ISO 14001:2015 ed EMAS (Regolamento CE N. 1221/2009).**

**I prodotti Panaria possiedono la certificazione EPD specifica di Tipo III, certificata da Ente indipendente di terza parte secondo EN 15804 ed EN 14025.**

### ISO 14001, EMAS AND EPD ENVIRONMENTAL CERTIFICATIONS

Panaria tiles are produced in manufacturing plants with environmental management systems compliant to ISO 14001:2015 and EMAS (EC Regulation 1221/2009).

Panaria products have a type III specific EPD. This is certified by an independent third party according to EN 14025 and EN 15804 standards.

CERTIFIED ENVIRONMENTAL MANAGEMENT SYSTEM



UNI EN ISO 14001:2015

CERTIFIED QUALITY MANAGEMENT SYSTEM



UNI EN ISO 9001:2015



GESTIONE AMBIENTALE CERTIFICATA  
REG. N. 1221/09



ECO - COMPATIBLE\_ÖKO - VERTRÄGLICH/ECO\_COMPATIBLE

### UMWELTZERTIFIKATE ISO 14001, EMAS ED EPD

Die Panaria Produktionsanlage besitzen die Umweltzertifizierung ISO 14001:2015 und EMAS (Regelung CE N. 1221/2009).

Die Produkte von Panaria besitzen die Zertifizierung EPD spezifisch von Typ III, von unabhängigen und fremden Anstalt gemäß EN 15804 und EN 14025 zertifiziert.

### CERTIFICATIONS ENVIRONNEMENTALES ISO 14001, EMAS ET EPD

Les sites productif Panaria sont équipés de Système de Gestion Environnementale certifié ISO 14001:2015 et EMAS (règlement CE N. 1221/2009).

Les produits Panaria sont certifiés EPD spécifique de Type III, la certification est La certification est effectué par un organisme indépendant tiers comme prévu par EN 15804 et EN 14025.



### RIUTILIZZO DEL 100% DEGLI SCARTI CRUDI

**Il 100% degli scarti crudi derivanti dal ciclo di produzione vengono riutilizzati nella fase di preparazione dell'impasto, contribuendo in modo sensibile alla salvaguardia delle risorse naturali riducendo l'estrazione di materie prime da cava.**

#### 100% INDUSTRIAL WASTE REUSED – NON FIRED TILES

The totality of the non fired material, which does not comply with our high quality standards, is reused in the production cycle. As these products are not yet fired, they can be reinserted in the initial phases of the production cycle. Recycling of this waste also reduces the need of raw materials.

#### WIEDERVERWERTUNG VON 100% DER ROHABFÄLLE

100% der Rohabfälle aus dem Produktionszyklus werden in der Vorbereitungsphase des Gemisches wiederverwertet und tragen somit ihren Teil zum Schutz der Naturressourcen bei, indem sie den Abbau von Rohmaterialien verringern.

#### REUTILISATION DE 100 % DES DÉCHETS BRUTS

100% des déchets bruts provenant du cycle de production sont réutilisés pendant la phase de préparation de la pâte, contribuant sensiblement à la préservation des ressources naturelles réduisant l'extraction de matières premières minières.



### RIUTILIZZO/RICICLO DEL 100% DEGLI SCARTI COTTI

**Gli scarti cotti sono completamente riutilizzati nel ciclo produttivo. Inoltre, a fine vita, le piastrelle Panaria possono essere riciclate come inerti per sottopavimenti di strade ed edifici, riducendo così l'uso di ghiaia ed inerti naturali comunemente utilizzati in edilizia.**

#### 100% REUSE/RECYCLING OF THE INDUSTRIAL WASTE – FIRED TILES

The waste-fired tiles are fully reused in the production cycle. In addition, at the end of life, the tiles Panaria can be recycled as materials for substrates for roads and buildings, thus reducing the use of gravel and natural aggregates commonly used in building.

#### WIEDERVERWENDEUNG-/VERWERTUNG ZU 100% DER BEIM BRENNEN DER FLIESEN ANFALLENDEN ABFÄLLE

Die beim Brennen der Fliesen anfallenden Abfälle werden vollständig wieder in den Produktionszyklus aufgenommen. Außerdem können die Fliesen Panaria nach ihrem "Lebensende" als inertes Material als Untergrund für Straßen oder Gebäude verwendet werden und somit den Einsatz von gewöhnlicherweise im Bauwesen eingesetzten Kies und inerten Naturmaterialien reduzieren.

#### RÉUTILISATION/RECYCLAGE DE 100% DES REBUTS DE CUISSON

Les rebuts de cuisson sont entièrement réutilisés dans le cycle de production. En fin de vie, les carreaux Panaria peuvent par ailleurs être utilisés comme granulats pour les soubassements de routes et de bâtiments, ce qui permet de réduire l'utilisation de gravier et de granulats naturels habituellement utilisés en construction.



### RICICLO DEL 100% DEI RIFIUTI NON CERAMICI

**Il 100% rifiuti non ceramici derivanti dalle attività produttive è gestito in modo differenziato e riciclato in altri processi produttivi.**

#### 100% INDUSTRIAL WASTE RECYCLED – NON CERAMIC WASTE

The totality of the non ceramic waste is differentiated and recycled in other production cycles.

#### 100% RECYCLING DES NICHT KERAMISCHEN ABFALLS

100% der während dem Produktionsprozess anfallenden nicht keramischen Abfälle wird getrennt verwaltet und in anderen Produktionsprozessen wiederverwertet.

#### RECYCLAGE DE 100% DES DÉCHETS NON CÉRAMIQUES

100% des déchets non céramiques provenant de production sont triés de façon sélective puis recyclés dans d'autres processus de production.



### RIUTILIZZO DEL 100% DELLE ACQUE DI PROCESSO

**La produzione di piastrelle di ceramica richiede ingenti quantitativi di acqua. Per salvaguardare questa importante risorsa naturale Panaria riutilizza il 100% delle acque reflue derivanti dal ciclo di produzione, generando una riduzione fino all'80% del fabbisogno idrico degli stabilimenti.**

#### 100% WASTE WATER RECYCLED – SAFEGUARD OF NATURAL RESOURCES

The production of tiles requires important amounts of water. So as to safeguard this precious resource Panaria recycles 100% of waste water from the production cycle. This allows the reduction of water consumption up to 80%. None of the water used in the production cycle is discharged into the ecosystem.

#### WIEDERVERWERTUNG VON 100% DES ABWASSERS

Die Herstellung von Keramikfliesen erfordert beträchtliche Wassermengen. Um diese wichtige Naturressource zu schützen, verwertet Panaria 100% der Abwässer des Produktionszyklus wieder und ermöglicht somit eine Reduktion des Wasserbedarfs in den Anlagen von bis zu 80%.

#### RÉUTILISATION DE 100% DES EAUX DE TRAITEMENT

La production de carrelages demande une quantité d'eau considérable. Pour préserver cette ressource naturelle importante, Panaria réutilise 100% des eaux usées provenant du cycle de production, ce qui permet de réduire jusqu'à 80 % des besoins hydrauliques des usines.



### BASSE EMISSIONI IN ATMOSFERA

**Gli importanti investimenti attuati nelle migliori tecnologie a disposizione permettono di realizzare i prodotti Panaria riducendo al minimo le emissioni gassose in atmosfera, raggiungendo livelli 10 volte inferiori ai severi limiti ambientali richiesti della legislazione italiana.**

#### LOW GAS EMISSIONS INTO THE ATMOSPHERE

Panaria complies strictly to Italian Standards. The strive for excellence has led us to invest in high quality technology that keeps our emissions 10 times inferior the allowed limits.

#### NIEDRIGE EMISSIONSWERTE

Dank der starken Investitionen in die modernsten, verfügbaren Produktionstechnologien ist es uns möglich, sämtliche Produkte von Panaria so herzustellen, dass die Schadstoffemissionen in die Atmosphäre auf das Geringste reduziert werden. Wir erreichen dabei ein Niveau, das 10 mal unter den strengen Grenzwerten der italienischen Gesetzgebung liegt.

#### BASSES ÉMISSIONS DANS L'ATMOSPHÈRE

Les importants investissements actuels dans les meilleures technologies qui sont à notre disposition permettent de réaliser les produits Panaria, en réduisant au minimum les émissions de gaz dans l'atmosphère, et en atteignant des niveaux dix fois inférieurs aux limites environnementales très sévères fixées par la législation italienne.



### FORTE RIDUZIONE DEI CONSUMI ENERGETICI

**L'uso di tecnologie all'avanguardia e di soluzioni impiantistiche ottimali riducono sensibilmente l'uso di gas metano nel processo produttivo.**

#### METHANE CONSUMPTION IS HIGHLY REDUCED

By the use of up to date technologies and customized installations.

#### BEACHTLICHE REDUZIERUNG DES ENERGIEBEDARFS

Der Einsatz fortschrittlicher Technologien und optimaler Lösungen beim Bau der Anlagen reduzieren den Einsatz von Methangas beim Produktionsprozess auf beachtliche Weise.

#### FORTE RÉDUCTION DES CONSOMMATIONS ÉNERGÉTIQUES

L'utilisation de technologies de pointe et de solutions d'installations optimales permettent de réduire considérablement la consommation de gaz méthane dans le processus de production.



### UTILIZZO DI IMBALLAGGI 100% RICICLABILI

**I materiali impiegati per gli imballaggi dei prodotti Panaria (quali scatole, cartone, plastica, palette in legno, etc.) sono completamente riciclabili.**

#### 100% RECYCLABLE MATERIAL USED FOR PACKING

The materials used for the packing of Panaria products are completely recyclable. These materials include carton boxes, plastic materials, wooden pallets, etc.

#### VERWENDUNG VON 100% RECYCLEBAREN VERPACKUNGEN

Die Materialien, die zur Verpackung der Produkte von Panaria verwendet werden (Schachteln, Kartons, Kunststoffe, Holzpaletten, usw.) sind vollständig recyclebar.

#### UTILISATION D'EMBALLAGES 100% RECYCLABLES

Les matériaux utilisés pour les emballages des produits Panaria (dont des boîtes, du carton, du plastique, des palettes en bois, etc.) sont complètement recyclables.



### PALLET FAO

**Panaria utilizza pallet senza corteccia conformi allo standard IPPC / FAO ISPM 15, offrendo quindi ai Paesi importatori ogni garanzia per la salvaguardia del proprio patrimonio forestale.**

#### FAO PALLETS

For shipments Panaria uses debarked pallets (DB), in accordance with the IPPC / FAO ISPM 15 standards. This is a further warranty for the forest safeguard of countries importing Panaria products.

#### FAO-PALETTE

Panaria verwendet gemäß dem Standard IPPC/FAO ISPM 15 Paletten ohne Rinde (DB) und gibt daher den Importländern die Garantie, den eigenen Waldbestand zu schützen.

#### PALETTES FAO

Panaria utilise des palettes sans écorce (DB) conformes aux normes IPPC / FAO ISPM 15, offrant donc aux Pays importateurs la garantie de la préservation du patrimoine forestier.

# Panaria e l'ambiente

Panaria and the environment\_Panaria und die Umwelt\_Panaria et l'environnement

## Zero.3 Materiale ideale per edifici a basso consumo energetico

Zero.3 Ideal material for low energy buildings\_Zero.3 ideal für energieeffiziente Gebäude\_

Zero.3 Matériau idéal pour édifices à faible consommation énergétique

# Zero.3

**Zero.3 è ideale per la costruzione di edifici a bassissimo consumo energetico; queste sono le applicazioni nelle quali Zero.3 è il materiale ottimale:**

### • FINITURA DI PAVIMENTI E RIVESTIMENTI

**Zero.3 è un prodotto realizzato con materie prime naturali che non contengono sostanze sintetiche, che offre prestazioni di sicurezza (resistenza al fuoco), pulibilità e durabilità decisamente superiori rispetto al legno e alla moquette.**

### • IMPIANTI DI RISCALDAMENTO A PAVIMENTO

**Zero.3 offre prestazioni di eccellenza poiché favorisce l'ottimizzazione del sistema completo con temperature più basse dell'acqua e di conseguenza il risparmio energetico dell'intero impianto (grazie al suo basso spessore e alla conducibilità termica superiore rispetto al legno che è materiale isolante).**

### • FINITURE SUPERFICIALI DI RIVESTIMENTI A CAPPOTTO E FACCIATE VENTILATE

**L'utilizzo di Zero.3 è indicato per la sua leggerezza, il grande formato e la facilità di installazione. Inoltre, rispetto a materiali lapidei o metallici e rispetto alle finiture ad intonaco, Zero.3 offre sicuramente una maggiore resistenza agli agenti atmosferici, allo smog, agli agenti chimici, alle macchie e ai graffiti, e caratteristiche di eccellenza per quanto riguarda la durabilità nel tempo (resistenza all'invecchiamento, all'azione della luce e del gelo).**

### • FINITURA DI PANNELLI DI TAMPONAMENTO ESTERNO PER STRUTTURE E CASE PREFABBRICATE

**Zero.3 è la soluzione ottimale grazie alle sue caratteristiche tecniche, alla sua leggerezza e al grande formato.**

Zero.3 is ideal for the construction of low energy consumption buildings and these are the applications in which Zero.3 is the optimal material:

### • FLOOR AND WALL COVERINGS

Zero.3 is manufactured with raw materials that do not contain any synthetic substances and therefore offers the security of fire resistance, durability and easy cleaning superior to that of wood and carpet.

### • FLOOR HEATING SYSTEMS

Zero.3 assists with the optimization of the complete system by requiring lower water temperatures and consequently saving energy. This is due to its thickness and thermal conductivity which render it superior to moquette and wood.

### • SURFACE COVERINGS FOR THERMAL INSULATION SYSTEMS AND VENTILATED FACADES

Zero.3 is recommended for its lightness, large size and easy installation. Moreover, when compared to stone, metallic or plaster materials Zero.3 offers a noticeably higher resistance to atmospheric agents, pollution, chemical agents, stains and graffiti, along with excellent durability (resistance to aging and the effects of light and frost).

### • FINISH OF EXTERNAL WALLS PLUGS FOR STRUCTURES AND PREFABRICATE BUILDINGS

Zero.3 is the perfect solution thanks to its technical characteristics, lightness and large sizes.

Zero.3 ist ideal für den Bau von Gebäuden mit sehr niedrigem Energieverbrauch; dies sind die Anwendungen, in denen Zero.3 das optimale Material ist:

### • ENDBEARBEITUNG VON BÖDEN UND WÄNDEN

Zero.3 ist ein Produkt aus natürlichen Rohstoffen, die keine synthetischen Substanzen enthalten, das eine Sicherheitsleistung (Brandschutz), Reinigungsfähigkeit und Haltbarkeit bietet, die Holz und Teppichen weit überlegen ist.

### • FUSSBODENHEIZUNGSSYSTEME

Zero.3 bietet eine ausgezeichnete Leistungen, da es die Optimierung des Gesamtsystems mit niedrigeren Wassertemperaturen und damit die Energieeinsparung des Gesamtsystems begünstigt (dank seiner geringen Stärke und höheren Wärmeleitfähigkeit im Vergleich zu Holz, das ein Dämmstoff ist).

### • OBERFLÄCHENVEREDELUNG VON AUSSENVERKLEIDUNGEN UND HINTERLÜFTETEN FASSADEN

Die Verwendung von Zero.3 ist wegen seiner Leichtigkeit, Größe und einfachen Installation angezeigt. Darüber hinaus bietet Zero.3 im Vergleich zu Stein- oder Metallmaterialien und Putzoberflächen eine höhere Beständigkeit gegen Witterungseinflüsse, Smog, Chemikalien, Flecken und Graffiti, und hat hervorragende Eigenschaften in Bezug auf die Langlebigkeit (Alterungsbeständigkeit, Licht- und Frosteinwirkung).

### • VEREDELUNG VON AUSSENVERKLEIDUNGSPLETTEN FÜR BAUWERKE UND FERTIGHÄUSER

Zero.3 ist aufgrund seiner technischen Eigenschaften, seiner Leichtigkeit und seines großen Formats die optimale Lösung.

Zero.3 est idéal pour la construction d'édifices à très faible consommation énergétique ; celles-ci sont les applications dans lesquelles Zero.3 est le matériau optimal :

### • FINITION DE SOLS ET REVÊTEMENTS

Zero.3 est un produit réalisé avec des matières premières naturelles qui ne contiennent pas de substances synthétiques, qui offre des prestations de sécurité (résistance au feu), nettoyabilité et durabilité nettement supérieures par rapport au bois et à la moquette.

### • INSTALLATIONS DE CHAUFFAGE AU SOL

Zero.3 offre des prestations d'excellence car il favorise l'optimisation du système complet avec des températures plus basses que l'eau et, par conséquent, l'économie d'énergie de toute l'installation (grâce à sa faible épaisseur et à la conductivité thermique supérieure par rapport au bois qui est un matériau isolant).

### • FINITIONS DE SURFACE DE REVÊTEMENTS AVEC MURS MANTEAU ET FAÇADES VENTILÉES

L'utilisation de Zero.3 est indiqué pour sa légèreté, le grand format et la facilité d'installation. De plus, par rapport aux matériaux en pierre ou métalliques et par rapport aux finitions à enduit, Zero.3 offre sûrement une plus grande résistance aux agents atmosphériques, à la pollution, aux agents chimiques, aux taches et aux graffitis, et des caractéristiques d'excellence en ce qui concerne la durabilité dans le temps (résistance au vieillissement, à l'action de la lumière et du gel).

### • FINITION DE PANNEAUX DE TAMPONNEMENT EXTÉRIEUR POUR STRUCTURES ET MAISONS PRÉFABRIQUÉES

Zero.3 est la solution optimale grâce à ses caractéristiques techniques, sa légèreté et son grand format.



# Certificazioni di sistema

Management system certifications\_Qualitätssystem Zertifizierungen\_Certifications du système de production

## Sistema di gestione della qualità certificato UNI EN ISO 9001

UNI EN ISO 9001 certified quality management system\_UNI EN ISO 9001 Qualitätsmanagementnorm\_  
Système de gestion de la qualité certifié UNI EN ISO 9001



**Ai sensi della Certificazione ISO 9001, tutte le fasi del processo produttivo, a partire dall'arrivo delle materie prime fino alla scelta e confezionamento del prodotto finito, vengono opportunamente verificate da personale esperto attraverso accurati controlli di qualità. Il sistema qualità dei siti produttivi Panariagroup viene verificato con frequenza annuale da un ente certificatore esterno attraverso accurate visite ispettive.**

In accordance to the ISO 9001 certification, every passage in the production process, from the arrival of the raw material to the packaging of the finished product, is verified by experienced personnel through accurate quality control. The quality of the Panariagroup production sites is audited yearly by an external agency through thorough inspections.

Gemäß der Zertifizierung ISO 9001 werden alle Phasen des Produktionsprozesses, von der Ankunft der Rohstoffe bis zur Wahl und Verpackung des Endprodukts, in geeigneter Weise von Fachpersonal durch eine sorgfältige Qualitätskontrolle überprüft. Das Qualitätssystem der Produktionsstätten der Panariagroup wird jährlich über eine externe Zertifizierungsstelle durch eingehende Inspektionsbesuche kontrolliert.

Conformément à la Certification ISO 9001, toutes les phases du processus de production, à partir de l'arrivée des matières premières jusqu'à la sélection et le conditionnement du produit fini, sont adéquatement vérifiées par du personnel expert qui effectue des contrôles de qualité approfondis. Le système qualité des sites de production Panariagroup est vérifié tous les ans par un organisme de certification extérieur au moyen de visites d'inspection rigoureuses.

## Sistema di gestione ambientale certificato UNI EN ISO 14001

UNI EN ISO 14001 certified environmental management system\_UNI EN ISO 14001 Umweltmanagementsystemnorm\_  
Système de gestion environnementale certifié UNI EN ISO 14001



**Sistema di gestione ambientale certificato UNI EN ISO 14001 dei siti produttivi.**

**Ai fini della Certificazione ISO 14001 tutti gli aspetti ambientali inerenti all'attività di produzione di piastrelle vengono costantemente controllati, garantendo l'utilizzo delle migliori tecnologie presenti sul mercato per ridurre al minimo gli impatti ambientali generati. Il sistema ambientale dei siti produttivi Panariagroup viene verificato con frequenza annuale da un ente certificatore esterno attraverso accurate visite ispettive.**

UNI EN ISO 14001 certified environmental management system of production sites.

In accordance to the ISO 14001 certification, all the environmental management aspects concerned in the production of our tiles are constantly monitored, guaranteeing the use of the best technologies on the market in order to reduce the environmental impact. The environmental system of the Panariagroup production sites is audited yearly by an external agency through thorough inspections.

Umweltmanagementsystem der Produktionsstätten nach UNI EN ISO 14001.

Für die Zwecke der ISO 14001-Zertifizierung werden alle mit der Herstellung von Fliesen zusammenhängenden Umweltaspekte kontinuierlich überwacht und der Einsatz der besten Technologien auf dem Markt gewährleistet, um die Umweltbelastung auf ein Minimum zu reduzieren. Das Umweltsystem der Produktionsstätten der Panariagroup wird jährlich von einer externen Zertifizierungsstelle durch eingehende Inspektionsbesuche kontrolliert.

Système de gestion environnementale certifié UNI EN ISO 14001 des sites de production.

Aux fins de la Certification ISO 14001, tous les aspects environnementaux relatifs à l'activité de production de carreaux sont constamment contrôlés, garantissant l'utilisation des meilleures technologies présentes sur le marché afin de réduire au minimum les impacts environnementaux qui sont générés. Le système environnemental des sites de production Panariagroup est contrôlé tous les ans par un organisme de certification extérieur au moyen de visites d'inspection rigoureuses.

## Certificazioni ambientali EMAS dei siti produttivi

EMAS Approved Environmental Management System of production sites\_Umweltzertifizierung EMAS der Produktionsstätten\_  
Système de Management environnemental Certificat EMAS des sites de production



**Il sistema comunitario di ecogestione ed audit EMAS è lo strumento con cui l'Unione Europea promuove il miglioramento continuo delle prestazioni ambientali delle organizzazioni - rif. Regolamenti (CE) 1221/2009 e (UE) 2017/1505 del Parlamento Europeo e del Consiglio. Panariagroup Industrie Ceramiche S.p.A. ha ottenuto la registrazione EMAS per tutti i suoi siti produttivi di Toano (RE) (N. registrazione I-000239), Finale Emilia (MO) (N. registrazione I-000309), Fiorano Modenese (MO) (N. registrazione I-000401) e Ilhavo/Aveiro (Portogallo) (N. registrazione PT-000097).**

**Questa registrazione riveste una grande importanza, perché impone la creazione di un vero Sistema di gestione Ambientale basato sul continuo miglioramento delle proprie prestazioni ambientali. Il sistema si basa sulla creazione di un rapporto di collaborazione e fiducia con le istituzioni del territorio (Enti, Autorità, Associazioni, Rappresentanze Sindacali, Scuole, Stampa) e con il pubblico, ed è prevista la partecipazione attiva di tutti i dipendenti.**

**La Dichiarazione Ambientale è il documento finale che descrive gli aspetti ambientali e di sicurezza sul lavoro, le prestazioni ambientali del sito e gli obiettivi ambientali che l'Azienda si impone di raggiungere nell'ottica del miglioramento continuo. La dichiarazione è convalidata da un Verificatore Ambientale Accreditato a seguito verifiche ispettive (audit) eseguite in stabilimento. Panaria è tra le pochissime aziende ceramiche ad avere la registrazione EMAS, che testimonia la massima attenzione e sensibilità del management alle questioni etiche, ambientali, di sicurezza e qualità.**

The Community Eco-Management and Audit Scheme (EMAS) is the tool through which the European Union promotes continuous improvement of the environmental performance of organizations - ref. Regulations (CE) 1221/2009 and (UE) 2017/1505 of the European Parliament and Council. Panariagroup Industrie Ceramiche S.p.A. has obtained EMAS Registration for all its production sites: Finale Emilia (MO) (registration N° I-000309), Toano (RE) (registration N° I-000239), Fiorano Modenese (MO) (registration N° I-000401) and Ilhavo/Aveiro (Portugal) (registration N° PT-000097).

This registration is of major importance, since it requires a proper Environmental Management System to be created, based on the continual improvement of environmental performance within organisations.

The scheme is based on the creation of an open dialogue with local institutions (Agencies, Authorities, Associations, Trade Union Representatives, Schools, Press) and with the public, and it is expected that all employees will play an active part.

The Environmental Statement is the end document that describes the environmental and safety aspects in the workplace, the environmental performance of the site and the environmental targets that the Company sets itself within the framework of continual improvement.

The statement is validated by an Accredited Environmental Verifier, following audits carried out in the plant. Panaria is one of the very few ceramics companies to have EMAS registration which bear witness to the management's utmost commitment and readiness to engage with the ethical, environmental, safety and quality issues.

Das Gemeinschaftssystem für Umweltmanagement und Umweltbetriebsprüfung EMAS ist das Instrument, mit dem die Europäische Union die kontinuierliche Verbesserung der Umwelleistung von Organisationen fördert - vgl. Verordnungen (EG) Nr. 1221/2009 und (EU) 2017/1505 des Europäischen Parlaments und des Rats.

Panariagroup Industrie Ceramiche S.p.A. ha die EMAS Registrierung für alle Produktionsstätten erhalten: Toano (RE) (Registrierungsnummer I-000239), Finale Emilia (MO) (Registrierungsnummer I-000309), Fiorano Modenese (MO) (Registrierungsnummer I-000401) und Ilhavo/Aveiro (Portugal) (Registrierungsnummer PT-000097). Diese Registrierung hat eine große Bedeutung, da sie die Schaffung eines wahren Umweltmanagement - systems auf der Grundlage der kontinuierlichen Verbesserung der Effizienz des Umweltcontrollings impliziert.

Das System basiert auf dem Aufbau einer kooperativen und von gegenseitigem Vertrauen geprägten Beziehung mit den territorialen Institutionen (öffentlichen Einrichtungen, Behörden, Verbänden, gewerkschaftlichen Vertretungen, Schulen, Presse) und der Öffentlichkeit. Des Weiteren ist die aktive Einbeziehung des gesamten Personals vorgesehen. Die Umweltschutzzerklärung ist das endgültige Dokument, in dem die Aspekte zum Umweltschutz und zur Sicherheit am Arbeitsplatz, die Initiativen zum Schutz der Umwelt an diesem Standort sowie die Ziele beschrieben werden, die das Unternehmen im Rahmen des kontinuierlichen Verbesserungsprozesses erreichen will.

Die Erklärung wird von einem zugelassenen Umweltgutachter nach vor Ort durchgeführten Inspektionen (Audits) genehmigt. Panaria ist einer der wenigen Keramikhersteller, der eine EMAS-Registrierung vorweisen kann, die das große Engagement und die Sensibilität des Unternehmens in Bezug auf Ethik, Umweltschutz, Sicherheit und Qualität unter Beweis stellt.

Le Système communautaire de Management environnemental et d'Audit est un instrument employé par l'Union européenne pour promouvoir l'amélioration constante des performances environnementales des organisations. - Référence : Règlements (CE) n° 1221/2009 et (UE) 2017/1505 du Parlement européen et du Conseil. Panariagroup Industrie Ceramiche S.p.A. a obtenu l'accréditation EMAS pour les trois sites de production: Finale Emilia (MO) (accréditation N° I - 000309), Toano (RE) (accréditation N° I-000239), Fiorano Modenese (MO) (accréditation N° I-000401) et Ilhavo/Aveiro (Portugal) (accréditation N° PT-000097).

Cette certification revêt une grande importance, car elle sous-entend la création d'un véritable Système de gestion de l'environnement, basé sur la perpétuelle amélioration des résultats obtenus en matière d'environnement. Le système repose sur la création d'un rapport de collaboration et de confiance avec les institutions du territoire (Institutions, Pouvoirs publics, Associations, Représentations syndicales, Écoles, Presses) et avec le public. Il est prévu que tous les employés participeront activement à ce programme. La Déclaration environnementale constitue le document final décrivant les éléments en matière d'environnement et de sécurité sur le lieu de travail, les efforts effectués par le site pour l'environnement et les objectifs que l'entreprise s'est fixés dans le cadre de cette amélioration perpétuelle.

La déclaration a été validée par un Contrôleur officiel suite aux inspections (audit) effectuées sur le site. Panaria fait partie des rares entreprises actives dans le domaine de la céramique disposant du certificat EMAS, qui témoigne de la plus grande attention et de la sensibilité de la part de la direction en ce qui concerne les questions éthiques, environnementales, de sécurité et de qualité.

# Certificazioni di prodotto

Product certification\_Produktzertifizierung\_Certifications de produit

## GREENGUARD GOLD

Greenguard Gold



**Il marchio GREENGUARD certifica i prodotti che negli ambienti interni garantiscono i più elevati standard di qualità dell'aria. Tutte le collezioni Panaria in gres porcellanato e Zero.3 hanno ottenuto la certificazione GREENGUARD GOLD, cioè lo standard di UL con i limiti più stringenti di emissioni di VOC, e sono perciò in grado di assicurare la migliore salubrità alle persone che vivono e che abitano gli ambienti. Per questo possono essere impiegate in ambienti come scuole e strutture sanitarie, frequentate da soggetti sensibili come i bambini e gli anziani. GREENGUARD GOLD è una certificazione ampiamente riconosciuta e richiesta dai programmi di edilizia sostenibile e dai regolamenti di progettazione e costruzione in tutto il mondo, come il LEED (internazionale) e il BREEAM (UK).**

GREENGUARD certifies products that guarantee the highest standards of air quality in indoor environments. All porcelain stoneware and Zero.3 Panaria collections have obtained GREENGUARD GOLD certification, i.e. the UL standard with the strictest VOC emission limits, and are therefore able to ensure that they are as healthy as possible for the people who use and inhabit these environments. They can therefore be used in environments such as schools and health facilities, attended by sensitive individuals such as children and the elderly. GREENGUARD GOLD is a widely recognised certification required by sustainable building programmes and design and construction regulations around the world, such as LEED (international) and BREEAM (UK).

Die Marke GREENGUARD zertifiziert die Produkte, die in Innenbereichen höchste Luftqualitätsstandards garantieren. Alle Panaria Kollektionen aus Feinsteinzeug und Zero.3 haben die GREENGUARD GOLD-Zertifizierung, d.h. den UL-Standard mit den strengsten Beschränkungen für VOC-Emissionen erhalten, und sind somit in der Lage, den Bewohnern der Räume maximale Gesundheit zu garantieren. Deshalb können sie in Umgebungen wie Schulen und Gesundheitseinrichtungen eingesetzt werden, die von empfindlichen Personen wie Kindern und älteren Menschen besucht werden. GREENGUARD GOLD ist eine weithin anerkannte Zertifizierung, die von nachhaltigen Bauprogrammen sowie weltweiten Planungs- und Bewertungssystemen wie LEED (international) und BREEAM (Vereinigtes Königreich) gefordert wird.

La marque GREENGUARD certifie les produits qui garantissent les standards de qualité de l'air les plus élevés dans les pièces intérieures. Toutes les collections Panaria en grès cérame et Zero.3 ont obtenu la certification GREENGUARD GOLD, qui est le standard de UL ayant les critères les plus sévères en matière d'émission de COV, et elles sont en mesure de garantir la meilleure salubrité aux personnes qui vivent et habitent les pièces. Elles peuvent donc être utilisées dans des locaux comme les structures sanitaires, fréquentées par des individus sensibles tels que les enfants et les personnes âgées. GREENGUARD GOLD est une certification amplement reconnue et exigée par les programmes de bâtiment durable et par les règlements de conception et construction du monde entier, comme le LEED (international) et le BREEAM (GB).

## Credit LEED V4

LEED V4 Credits\_Kredite LEED V4\_Crédits LEED V4



**Panaria è membro del U.S. Green Building Council e del Green Building Council ITALIA, organizzazioni che promuovono la realizzazione di edifici ed opere nel rispetto dell'ambiente, della salute e del benessere delle persone che ci vivono e lavorano. LEED V4 nasce da U.S. Green Building Council per offrire a progettisti, architetti e costruttori un nuovo strumento per realizzare edifici secondo standard più esigenti in termini di sostenibilità, salubrità e vivibilità. Anche per i materiali da costruzione, tra cui le piastrelle di ceramica, vengono richiesti requisiti più severi e più completi, tra cui anche la Dichiarazione Ambientale EPD. Le schede LEED delle serie Panaria sono disponibili su richiesta, sia secondo il protocollo LEED V4 che secondo i protocolli del GBC Italia.**

Panaria is a member of the U.S. Green Building Council and of the Green Building Council ITALIA. These organizations promote the construction of buildings and other works which respect the environment as well as the health and well-being of the people who live and work within them. LEED V4 was created by the U.S. Green Building Council to provide designers, architects, and builders with a new tool for the construction of buildings that adhere to more elevated standards of sustainability, health, and liveability. More stringent and thorough requisites are required of building materials, like ceramic tiles, including the Environmental Product Declaration (EPD). The LEED data sheets for Panaria are available upon request, according to both the LEED V4 and GBC Italia protocols.

Panaria ist ein Mitglied des US-Green Building Councils und des Green Building Councils ITALIA, beides Organisationen, die den Bau von Gebäuden und Strukturen unter Beachtung der Umwelt, Gesundheit und des Wohlbefindens der Menschen, die darin leben und arbeiten fördern. LEED V4 ist ein Projekt des US-Green Building Councils, um Designern, Architekten und Konstrukteuren ein neues Instrument zu liefern, Gebäude gemäß den anspruchsvollsten Standards in Bezug auf Nachhaltigkeit, Gesundheit und Lebensqualität zu realisieren. Auch für Baumaterialien, einschließlich keramischer Fliesen, werden strengere und vollständiger Anforderungen, einschließlich der Umwelterklärung EPD verlangt. Die LEED-Karten der Serie Panaria sind auf Anfrage erhältlich, sowohl gemäß dem Protokoll LEED-V4 als auch gemäß den Protokollen des GBC Italien.

Panaria est membre de l'U.S. Green Building Council et du Green Building Council d'Italie. Ces organisations promeuvent la réalisation de bâtiments et de travaux qui respectent l'environnement, la santé et le bien-être des personnes qui travaillent à la réalisation et de celles pour lesquelles elle est destinée. LEED V4 a été créé par U.S. Green Building Council pour offrir aux designers, architectes et constructeurs, un nouvel outil capable de répondre aux dernières exigences de réalisation en termes de durabilité, salubrité et bien-être. Pour les matériaux de construction, tels que les carreaux en céramique, les exigences sont encore plus sévères et plus complètes, et doivent être accompagnés notamment d'une Déclaration Environnementale Produit (DEP). Les fiches LEED des séries Panaria sont disponibles sur demande, selon le protocole LEED V4 ainsi que selon les protocoles GBC Italie.

## EPD - Dichiarazione Ambientale di Prodotto

EPD - Environmental Product Declaration\_EPD - Umwelt-Produktdeklaration\_  
DEP - Déclaration Environnementale Produit



**La Dichiarazione Ambientale di Prodotto (EPD) comunica in modo trasparente le prestazioni ambientali del gres porcellanato Panaria basandosi sull'analisi del ciclo di vita (LCA). I prodotti Panaria possiedono EPD specifica di tipo III, certificata da ente terzo indipendente secondo le normative EN 14025 e EN 15804 (PCR di riferimento). I Prodotti certificati EPD sono richiesti dai principali sistemi di certificazione degli edifici quali LEED (internazionale), BREEAM (Inghilterra), HQE (Francia) e DGNB (Germania), nonché in schemi legislativi in Italia (requisiti per appalti pubblici sostenibili). È una certificazione volontaria, che valorizza ancor più i materiali Panaria perché prodotti secondo i migliori standard di sostenibilità e responsabilità.**

The Environmental Product Declaration (EPD) is a transparency tool that communicates the environmental performances of Panaria porcelain tile through a Life Cycle Assessment (LCA). Panaria products have a type III specific EPD. This is certified by an independent third party according to EN 14025 and EN 15804 standards (applicable PCR). EPD certified products are required by the main construction certifying bodies such as LEED (international), BREEAM (England), HQE (France), and DGNB (Germany), as well as the legislative frameworks in Italy (requisites for sustainable public contracts). It is a voluntary certification that gives additional value to Panaria products because they are manufactured according to the highest standards of sustainability and responsibility.

Die Umwelt-Produktdeklaration (EPD) teilt in einer transparenten Art und Weise die Umweltleistung von Feinsteinzeug Panaria auf der Grundlage der "Lebenszyklusanalyse" (LCA) mit. Die Produkte Panaria verfügen über eine EPD vom Typ III, die von einem unabhängigen Dritten nach den Normen EN 14025 und EN 15804 (Referenz-PCR) zertifiziert wurde. EPD-zertifizierte Produkte werden von den wichtigsten Gebäudezertifizierungssystemen gefordert, wie z.B. LEED (International), BREEAM (England), HQE (Frankreich) und DGNB (Deutschland), sowie in Gesetzgebungsregelungen in Italien (Anforderungen für nachhaltige öffentliche Beschaffung) verlangt wird. Es ist eine freiwillige Zertifizierung, die die Materialien Panaria Produkte weiter aufwertet, da sie nach den höchsten Standards der Nachhaltigkeit und Verantwortung produziert werden.

La Déclaration Environnementale Produit (DEP) communique de manière transparente les performances environnementales du grès cérame Panaria en se basant sur l'analyse du cycle de vie (ACV). Les produits Panaria possèdent la déclaration environnementale (DEP) de type III, certifiée par un tiers indépendant conformément aux normes EN 14025 et EN 15804 (PCR de référence). Les produits certifiés DEP sont requis par les principaux organismes de certification pour la construction comme LEED (pour l'international), BREEAM (Angleterre), HQE (France) et DGNB (Allemagne), et par les cadres législatifs prévus en Italie (conditions pour participer aux marchés publics durables). Cette certification est une démarche volontaire, et vise à apporter une valeur supplémentaire aux matériaux Panaria, fabriqués de manière responsable et selon les meilleurs standards écologiques.

## Contenuto di materiale riciclato 40%

Recycled content 40%\_Inhaltverhalten von wiederverwertetem Material 40%\_  
Contenu de matériel recyclé 40%



**Panaria: piastrelle ecologiche studiate per riutilizzare nell'impasto ceramico materiale riciclato proveniente da altri processi produttivi. Questo si traduce in un minore utilizzo di risorse naturali ed un maggior rispetto per l'ambiente. Le serie certificate 40% sono indicate all'interno del catalogo generale e sul sito www.panaria.it**

Panaria: ecological tiles made with recycled material coming from other previous productions. This involves a lower use of natural resources and helps respecting the environment. The series certified 40% are shown inside the general catalogue and in our website www.panaria.it

Panaria: Ökologische Fliesen, die Zur Wiederverwendung in Keramikmischung von recycelten Material aus anderen Produktionsprozessen spezifisch geplant sind. Dies bedeutet eine sparsamere Nutzung der natürlichen Ressourcen und einer größeren Respekt für die Umwelt. Die Serien mit 40% Zeugnis sind auf del Generalkatalog und auf den Web-site www.panaria.it hingewiesen.

Panaria: des carreaux écologiques étudiés pour réutiliser dans le mélange céramique les matières recyclées provenant d'autres procédés productifs. Ce qui assure une consommation moindre des ressources naturelles et un plus grand respect de l'environnement. Les séries certifiées 40% sont indiquées dans le catalogue général et sur notre site-web www.panaria.it

# Certificazioni di prodotto

Product certification\_Produktzertifizierung\_Certifications de produit

## Marchio europeo CE di sicurezza

CE Security Mark\_Europäisches CE Sicherheitszeichen\_Certificat européen de sécurité CE



La marcatura CE è la certificazione di sicurezza del prodotto richiesta dall'Unione Europea, ed ha lo scopo di salvaguardare la salute delle persone e i beni nelle opere di costruzione. Il Regolamento UE N. 305/2011 entra in vigore il 1 luglio 2013. La novità più rilevante è l'introduzione della Dichiarazione di Prestazione (DOP, Declaration Of Performance) con la quale il fabbricante comunica i requisiti di sicurezza dei propri materiali. I prodotti Panaria sono in possesso del marchio CE (cfr. DOP001PAN - DOP002PAN - DOP004PAN - DOP005PAN - DOP006PAN). Le DOP di Panaria sono disponibili sul sito internet [www.panaria.it](http://www.panaria.it).

The CE mark is the safety product certification required by EU and it is finalized to preserve the people's health and the goods in buildings. The new Regulation UE N. 305/2011 is valid from the first of July 2013. The most important news is the introduction of the Declaration Of Performance (DOP) with which the supplier communicates the safety requirements concerning own materials. Panaria products have the CE mark (cf. DOP001PAN - DOP002PAN - DOP004PAN - DOP005PAN - DOP006PAN).

Panaria DOP are available on the website [www.panaria.it](http://www.panaria.it)

Das CE- Kennzeichnung ist die von EU angefragte Zertifizierung für die Produkt- Sicherheit, und hat das Zweck die Gesundheit der Menschen zu schützen und die Güter in der Bauphase zu bewahren. Die neue Regelung UE N. 305/2011 tritt am 1.07.2013 in Kraft. Die wichtigste Neuheit ist die Einfügung der Leistungserklärung (DOP, Declaration Of Performance), mit der der Hersteller die Sicherheitsanforderungen eigenen Materialien mitteilt. Panaria-Produkte haben das CE-Zeichen (siehe DOP001PAN - DOP002PAN - DOP004PAN - DOP005PAN - DOP006PAN).

Die DOP Panaria sind auf Internet Site [www.panaria.it](http://www.panaria.it) verfügbar

La marque CE est la certification de sécurité des produits demandé par l'Union Européenne ayant comme objectif la protection et la santé des personnes et des biens dans les ouvrages du bâtiments. Le nouveau Règlement UE Nr. 305/2011 entre en vigueur le 1<sup>er</sup> Juillet 2013. La nouveauté la plus importante est l'introduction de la Déclaration de Prestation (DOP, Declaration Of Performance) par la quelle le fabricant communique les caractéristiques de sécurité de ses produits. Les produits Panaria portent le marquage CE (cfr. DOP001PAN - DOP002PAN - DOP004PAN - DOP005PAN - DOP006PAN).

Les DOP de Panaria sont disponibles sur le site internet [www.panaria.it](http://www.panaria.it)

## KEY MARK e UNI-CERTIQUALITY

KEY MARK and UNI-CERTIQUALITY\_KEY MARK und UNI-CERTIQUALITY\_KEY MARK et UNI-CERTIQUALITY



Il marchio KEY-MARK e il marchio Certiquality-UNI attestano che i prodotti certificati sono conformi alle normative europee per le piastrelle ceramiche.

The KEY-MARK and the Certiquality-UNI marks confirm that the certified products are compliant with the EU laws regarding ceramic tiles.

Die Kennzeichnung KEY-MARK und die Kennzeichnung Certiquality-UNI bescheinigen, dass die zertifizierten Produkte den Europäischen Richtlinien für Keramikfliesen entsprechen.

Le Label KEY-MARK et le Label Certiquality-UNI attestent que les produits certifiés sont conformes aux normes européennes pour les carreaux céramiques.

## Classificazione QB-UPEC

QB-UPEC classification\_QB-UPEC-Klassifizierung\_Clasement QB-UPEC



È una certificazione di prodotto, rilasciata dall'istituto francese CSTB, che verifica l'idoneità tecnica dei prodotti di prima scelta in relazione al tipo di destinazione d'uso.

This is a product approval certificate, issued by the French Institute CSTB, who verifies the technical suitability of top quality products in relation to the type of use intended.

Es handelt sich um eine Produktzertifizierung, die vom französischen Institut CSTB ausgestellt wird. Die Behörde prüft die technische Eignung von Erzeugnissen erster Wahl im Verhältnis zu ihrem Verwendungszweck.

Il s'agit d'une certification de produit, délivrée par l'Établissement français CSTB, qui vérifie la conformité technique des produits de premier choix par rapport à la destination d'usage.

# Prodotti certificati

Certified products\_Zertifizierte Erzeugnisse\_Produts certifiés

COLLEZIONE COLLECTION COLLECTION	UPEC	UPEC-F+ (Épaisseur 20 mm)	40% PANARIA CERAMICA recycled ceramic content (DOP001PAN - DOP002PAN - DOP004PAN - DOP005PAN - DOP006PAN) LEED COMPLIANT CREDIT MR
ASSI D'ALPE			•
BIOARCH	•	•	•
BOREALIS			•
CONTEXT	•	•	•
CROSS WOOD			•
DISCOVER	•	•	•
ETERNITY			•
HORIZON	•	•	•
MEMORY MOOD	•	•	•
NORTH CAPE			•
NUANCE	•	•	•
OPIFICIO 22/A	•	•	•
PIERRE DES RÊVES	•	•	•
PETRA SOLIS	•	•	•
PIETRE DI FANES	•		•
PRIME STONE	•	•	•
TRILOGY			•
URBANATURE	•	•	•
Linea Fiorido FRAME	•	•	•
Linea Fiorido GENESIS	•		•
Linea Fiorido MOTION			•
Linea Fiorido ROCK STYLE			•
Linea Fiorido TRACKS	•	•	•
Linea Fiorido WOOD RELIVE			•

**UNI-CERTIQUALITY / KEY MARK**  
I certificati sono disponibili su richiesta  
Certificates are available upon request  
Zertifikate sind auf Anfrage erhältlich  
Les certificats sont disponibles sur demande

I classements UPEC dei singoli prodotti Panaria, compresi quelli delle nuove collezioni 2021, sono scaricabili dal sito [www.cstb.fr](http://www.cstb.fr) o tramite il link <http://webapp.cstb.fr/upec-ceramique/index.php>. I certificati del contenuto di riciclato, compresi gli aggiornamenti 2021, sono scaricabili dal sito [www.panaria.it](http://www.panaria.it) alla sezione **Download/Certificazioni**. The UPEC classifications of the individual Panaria products, including those in the new 2021 collections, can be downloaded from [www.cstb.fr](http://www.cstb.fr) or via the link <http://webapp.cstb.fr/upec-ceramique/index.php>. Recycled content certificates, including the 2021 updates, can be downloaded from [www.panaria.it](http://www.panaria.it) in the Downloads/Certifications section. Die UPEC-Klassifizierungen der einzelnen Produkte von Panaria, darunter auch jene der neuen Kollektionen 2021, können von der Seite [www.cstb.fr](http://www.cstb.fr) oder über den Link <http://webapp.cstb.fr/upec-ceramique/index.php> heruntergeladen werden. Die Zertifikate zum Recyclinganteil, darunter auch die Aktualisierungen 2021, können von der Seite [www.panaria.it](http://www.panaria.it) im Bereich Download/Zertifizierungen heruntergeladen werden. Les classements UPEC de chaque produit Panaria, y compris ceux des nouvelles collections 2021, peuvent être téléchargés sur le site [www.cstb.fr](http://www.cstb.fr) ou à travers le lien <http://webapp.cstb.fr/upec-ceramique/index.php>. Les certificats sur la teneur en matière recyclée, y compris les mises à jour 2021, peuvent être téléchargés sur le site [www.panaria.it](http://www.panaria.it) dans la section Téléchargement /Certifications

# Indice alfabetico dei prodotti

List of products in alphabetical order\_Alphabetisches verzeichnis der Produkte\_Index alphabétique des produits

PRODOTTO PRODUCT PRODUKT PRODUIT	TECNOLOGIA TECHNOLOGY TECHNOLOGIE TECHNOLOGIE	SPESSORE THICKNESS STÄRKE ÉPAISSEUR	SERIE SERIES SÉRIE SÉRIE	EFFETTO LOOK OPTIK EFFET	PAGINA PAGE SEITE PAGE
<b>A</b>					
ABISKO naturale		9,5/10,5 mm			
ABISKO ext	GRES PORCELLANATO A MASSA COLORATA_COLOURED-BODY PORCELAIN STONEWARE	9,5 mm	BOREALIS	legno_wood	303
ABISKO strutturato		20 mm			
ABYSS naturale	GRES PORCELLANATO LAMINATO_LAMINATED PORCELAIN STONEWARE	6 mm	STONE TRACE	pietra_stone	155
ALASKA naturale	GRES PORCELLANATO SMALTATO_GLAZED PORCELAIN STONEWARE	9,5 mm	WOOD RELIVE Linea Fiordo	legno_wood	345
ALTA naturale		9,5/10,5 mm			
ALTA ext	GRES PORCELLANATO A MASSA COLORATA_COLOURED-BODY PORCELAIN STONEWARE	9,5 mm	BOREALIS	legno_wood	303
ALTA strutturato		20 mm			
ARABESQUE PEARL lux	GRES PORCELLANATO LAMINATO_LAMINATED PORCELAIN STONEWARE	6 mm			
	GRES PORCELLANATO A MASSA COLORATA_COLOURED-BODY PORCELAIN STONEWARE	9,5 mm			
	GRES PORCELLANATO LAMINATO_LAMINATED PORCELAIN STONEWARE	6 mm	ETERNITY	marmo_marble	261
ARABESQUE PEARL soft		9,5 mm			
ARGILLA naturale		8/9,5 mm			
ARGILLA ext	GRES PORCELLANATO A MASSA COLORATA_COLOURED-BODY PORCELAIN STONEWARE	9,5 mm	OPIFICIO 22/A	cemento_concrete	227
ARGILLA strutturato		20 mm			
ASH naturale	GRES PORCELLANATO A MASSA COLORATA_COLOURED-BODY PORCELAIN STONEWARE	9,5 mm	TRACKS Linea Fiordo	pietra_stone	163
ASH strutturato		20 mm			
AURORE naturale		9,5 mm			
AURORE ext	GRES PORCELLANATO A MASSA COLORATA_COLOURED-BODY PORCELAIN STONEWARE	9,5 mm	PIERRE DES RÊVES	pietra_stone	113
AURORE strutturato		12/20 mm			
<b>B</b>					
BADIA naturale	GRES PORCELLANATO A MASSA COLORATA_COLOURED-BODY PORCELAIN STONEWARE	9,5 mm	ASSI D'ALPE	legno_wood	291
BARGE GIALLA spazzolata		9,5 mm			
BARGE GIALLA strutturato	GRES PORCELLANATO A MASSA COLORATA_COLOURED-BODY PORCELAIN STONEWARE	9/12/20 mm	BIOARCH	pietra_stone	53
BARGE GRIGIA spazzolata		9,5 mm			
BARGE GRIGIA strutturato		9/12/20 mm			
BE BLACK lux		5,5 mm			
BE BLACK soft	GRES PORCELLANATO LAMINATO_LAMINATED PORCELAIN STONEWARE	5,5 mm	MUST	cromatico_chromatic	389
BE WHITE lux		5,5 mm			
BE WHITE soft		5,5 mm			
BEIGE TENUE naturale	GRES PORCELLANATO LAMINATO_LAMINATED PORCELAIN STONEWARE	3,5 mm	EXPERIENCE	cemento_concrete	185
BIANCO DENSO naturale	GRES PORCELLANATO LAMINATO_LAMINATED PORCELAIN STONEWARE	3,5 mm	EXPERIENCE	cemento_concrete	185
BIRTH naturale	GRES PORCELLANATO A MASSA COLORATA_COLOURED-BODY PORCELAIN STONEWARE	9,5 mm	GENESIS Linea Fiordo	cemento_concrete	193
BLACK PRIME naturale	GRES PORCELLANATO LAMINATO_LAMINATED PORCELAIN STONEWARE	5,5 mm			
BLACK PRIME soft		9,5 mm	PRIME STONE	pietra_stone	133
BLACK PRIME lux	GRES PORCELLANATO A MASSA COLORATA_COLOURED-BODY PORCELAIN STONEWARE	9,5 mm			
BLAK PRIME strutturato		20 mm			
BOISERIE BEIGE	GRES PORCELLANATO LAMINATO_LAMINATED PORCELAIN STONEWARE	3,5 mm	GLAM	cromatico_chromatic	379
BOISERIE MAUVE	GRES PORCELLANATO LAMINATO_LAMINATED PORCELAIN STONEWARE	3,5 mm	GLAM	cromatico_chromatic	379
BONE naturale	GRES PORCELLANATO A MASSA COLORATA_COLOURED-BODY PORCELAIN STONEWARE	9,5 mm	CROSS WOOD	legno_wood	315
BREACH GREY lux	GRES PORCELLANATO LAMINATO_LAMINATED PORCELAIN STONEWARE	6 mm			
	GRES PORCELLANATO A MASSA COLORATA_COLOURED-BODY PORCELAIN STONEWARE	9,5 mm	ETERNITY	marmo_marble	261
	GRES PORCELLANATO LAMINATO_LAMINATED PORCELAIN STONEWARE	6 mm			
BREACH GREY soft	GRES PORCELLANATO A MASSA COLORATA_COLOURED-BODY PORCELAIN STONEWARE	9,5 mm			
BUFF naturale		9,5 mm			
BUFF ext	GRES PORCELLANATO A MASSA COLORATA_COLOURED-BODY PORCELAIN STONEWARE	9,5 mm	CROSS WOOD	legno_wood	315
BUFF strutturato		20 mm			
<b>C</b>					
CALACATTA WHITE	RIVESTIMENTO MONOPOROSA IN PASTA BIANCA SMALTATA_GLAZED WHITE BODY POROUS SINGLE-FIRED WALL TILES	10,5 mm			
CALACATTA WHITE lux	GRES PORCELLANATO LAMINATO_LAMINATED PORCELAIN STONEWARE	5,5 mm			
	GRES PORCELLANATO A MASSA COLORATA_COLOURED-BODY PORCELAIN STONEWARE	9,5 mm	TRILOGY	marmo_marble	277
	GRES PORCELLANATO LAMINATO_LAMINATED PORCELAIN STONEWARE	5,5 mm			
CALACATTA WHITE soft		9,5 mm			
CALCE naturale		8/9,5 mm			
CALCE ext	GRES PORCELLANATO A MASSA COLORATA_COLOURED-BODY PORCELAIN STONEWARE	9,5 mm	OPIFICIO 22/A	cemento_concrete	227
CALCE strutturato		20 mm			
CARAMEL naturale		9,5/10,5 mm			
CARAMEL strutturato	GRES PORCELLANATO A MASSA COLORATA_COLOURED-BODY PORCELAIN STONEWARE	9,5/20 mm	NUJANCE	legno_wood	333
CARBON naturale	GRES PORCELLANATO SMALTATO_GLAZED PORCELAIN STONEWARE	9,5 mm	MOTION Linea Fiordo	cemento_concrete	215
	GRES PORCELLANATO LAMINATO_LAMINATED PORCELAIN STONEWARE	3,5 mm			
CEMENT naturale		9,5 mm	URBANATURE	cemento_concrete	241
CEMENT strutturato	GRES PORCELLANATO A MASSA COLORATA_COLOURED-BODY PORCELAIN STONEWARE	20 mm			
CENDRE naturale		9,5/10,5 mm			
CENDRE strutturato	GRES PORCELLANATO A MASSA COLORATA_COLOURED-BODY PORCELAIN STONEWARE	9,5 mm	NUJANCE	legno_wood	333
CENERE naturale		8/9,5 mm			
CENERE ext	GRES PORCELLANATO A MASSA COLORATA_COLOURED-BODY PORCELAIN STONEWARE	9,5 mm	OPIFICIO 22/A	cemento_concrete	227
CENERE strutturato		20 mm			
CHALET naturale	GRES PORCELLANATO A MASSA COLORATA_COLOURED-BODY PORCELAIN STONEWARE	9,5 mm	ASSI D'ALPE	legno_wood	291
CHARME naturale		9,5 mm			
CHARME ext	GRES PORCELLANATO A MASSA COLORATA_COLOURED-BODY PORCELAIN STONEWARE	9,5 mm	PIERRE DES RÊVES	pietra_stone	113
CHARME strutturato		20 mm			
CHERRY	RIVESTIMENTO MONOPOROSA IN PASTA BIANCA SMALTATA_GLAZED WHITE BODY POROUS SINGLE-FIRED WALL TILES	10,5 mm	EVEN	cromatico_chromatic	359
CIASA naturale	GRES PORCELLANATO A MASSA COLORATA_COLOURED-BODY PORCELAIN STONEWARE	9,5 mm	ASSI D'ALPE	legno_wood	291
CINDER naturale		9,5 mm			
CINDER ext	GRES PORCELLANATO A MASSA COLORATA_COLOURED-BODY PORCELAIN STONEWARE	9,5 mm	CROSS WOOD	legno_wood	315
CINDER strutturato		20 mm			
CLEAR naturale	GRES PORCELLANATO SMALTATO_GLAZED PORCELAIN STONEWARE	9,5 mm	MOTION Linea Fiordo	cemento_concrete	215

PRODOTTO PRODUCT PRODUKT PRODUIT	TECNOLOGIA TECHNOLOGY TECHNOLOGIE TECHNOLOGIE	SPESSORE THICKNESS STÄRKE ÉPAISSEUR	SERIE SERIES SÉRIE SÉRIE	EFFETTO LOOK OPTIK EFFET	PAGINA PAGE SEITE PAGE
CLOUD naturale		9,5 mm			
CLOUD strutturato	GRES PORCELLANATO A MASSA COLORATA_COLOURED-BODY PORCELAIN STONEWARE	9,5/20 mm	HORIZON	pietra_stone	89
COLORFUL	GRES PORCELLANATO LAMINATO_LAMINATED PORCELAIN STONEWARE	3,5 mm	GLAM	cromatico_chromatic	379
	GRES PORCELLANATO LAMINATO_LAMINATED PORCELAIN STONEWARE	3,5 mm			
CONCRETE naturale		9,5 mm	URBANATURE	cemento_concrete	241
	GRES PORCELLANATO A MASSA COLORATA_COLOURED-BODY PORCELAIN STONEWARE	9,5 mm			
COPPER naturale	GRES PORCELLANATO A MASSA COLORATA_COLOURED-BODY PORCELAIN STONEWARE	9/9,5 mm	MEMORY MOOD	cemento_concrete	205
CREAMY naturale	GRES PORCELLANATO A MASSA COLORATA_COLOURED-BODY PORCELAIN STONEWARE	9/9,5 mm	MEMORY MOOD	cemento_concrete	205
CREEK naturale	GRES PORCELLANATO LAMINATO_LAMINATED PORCELAIN STONEWARE	6 mm	STONE TRACE	pietra_stone	155
CREST naturale	GRES PORCELLANATO LAMINATO_LAMINATED PORCELAIN STONEWARE	6 mm	STONE TRACE	pietra_stone	155
<b>D</b>					
DIM naturale		9/9,5 mm			
DIM strutturato	GRES PORCELLANATO A MASSA COLORATA_COLOURED-BODY PORCELAIN STONEWARE	20 mm	MEMORY MOOD	cemento_concrete	205
DONEGAL naturale		9,5/10,5 mm			
DONEGAL ext	GRES PORCELLANATO A MASSA COLORATA_COLOURED-BODY PORCELAIN STONEWARE	9,5 mm	BOREALIS	legno_wood	303
DONEGAL strutturato		20 mm			
DOVE	RIVESTIMENTO MONOPOROSA IN PASTA BIANCA SMALTATA_GLAZED WHITE BODY POROUS SINGLE-FIRED WALL TILES	10,5 mm	EVEN	cromatico_chromatic	359
DROVE naturale	GRES PORCELLANATO A MASSA COLORATA_COLOURED-BODY PORCELAIN STONEWARE	9,5/10,5 mm	NORTH CAPE	legno_wood	321
DUN naturale	GRES PORCELLANATO SMALTATO_GLAZED PORCELAIN STONEWARE	9,5 mm	MOTION Linea Fiordo	cemento_concrete	215
DUST naturale		9,5 mm			
DUST ext	GRES PORCELLANATO A MASSA COLORATA_COLOURED-BODY PORCELAIN STONEWARE	9,5 mm	CROSS WOOD	legno_wood	315
DUST strutturato		20 mm			
<b>E</b>					
EBONY naturale		9,5 mm			
EBONY ext	GRES PORCELLANATO A MASSA COLORATA_COLOURED-BODY PORCELAIN STONEWARE	9,5 mm	CROSS WOOD	legno_wood	315
<b>F</b>					
FABULA naturale		10 mm	PETRA SOLIS	pietra_stone	99
FABULA strutturato	GRES PORCELLANATO A MASSA COLORATA_COLOURED-BODY PORCELAIN STONEWARE	10/20 mm			
FLORIDA naturale	GRES PORCELLANATO SMALTATO_GLAZED PORCELAIN STONEWARE	9,5 mm	WOOD RELIVE Linea Fiordo	legno_wood	345
<b>G</b>					
GEM	RIVESTIMENTO MONOPOROSA IN PASTA BIANCA SMALTATA_GLAZED WHITE BODY POROUS SINGLE-FIRED WALL TILES	10,5 mm	WALLCRAFT	cromatico_chromatic	401
GEDSO naturale		8/9,5 mm			
GEDSO ext	GRES PORCELLANATO A MASSA COLORATA_COLOURED-BODY PORCELAIN STONEWARE	9,5 mm	OPIFICIO 22/A	cemento_concrete	227
GEDSO strutturato		20 mm			
GLADE naturale	GRES PORCELLANATO LAMINATO_LAMINATED PORCELAIN STONEWARE	6 mm	STONE TRACE	pietra_stone	155
GLEN naturale		9,5 mm	FRAME Linea Fiordo	pietra_stone	77
GLEN strutturato	GRES PORCELLANATO A MASSA COLORATA_COLOURED-BODY PORCELAIN STONEWARE	9,5/20 mm			
GLOAM naturale	GRES PORCELLANATO A MASSA COLORATA_COLOURED-BODY PORCELAIN STONEWARE	9,5 mm	GENESIS Linea Fiordo	cemento_concrete	193
GORGE naturale		9,5 mm	FRAME Linea Fiordo	pietra_stone	77
GORGE strutturato	GRES PORCELLANATO A MASSA COLORATA_COLOURED-BODY PORCELAIN STONEWARE	9,5/20 mm			
GREENWALL	GRES PORCELLANATO LAMINATO_LAMINATED PORCELAIN STONEWARE	3,5 mm	GLAM	cromatico_chromatic	379
GREIGE PRIME naturale	GRES PORCELLANATO LAMINATO_LAMINATED PORCELAIN STONEWARE	5,5 mm			
GREIGE PRIME soft		9,5 mm	PRIME STONE	pietra_stone	133
GREIGE PRIME lux	GRES PORCELLANATO A MASSA COLORATA_COLOURED-BODY PORCELAIN STONEWARE	9,5 mm			
GREIGE PRIME strutturato		20 mm			
GRIGIO MISTO strutturato	GRES PORCELLANATO TUTTA MASSA_FULL-BODY PORCELAIN STONEWARE	9 mm	PIETRE DI FANES	pietra_stone	121
GRIGIO VIVO naturale	GRES PORCELLANATO LAMINATO_LAMINATED PORCELAIN STONEWARE	3,5 mm	EXPERIENCE	cemento_concrete	185
GROOVE naturale		9,5 mm	FRAME Linea Fiordo	pietra_stone	77
GROOVE strutturato	GRES PORCELLANATO A MASSA COLORATA_COLOURED-BODY PORCELAIN STONEWARE	9,5/20 mm			
GUTULIA naturale	GRES PORCELLANATO A MASSA COLORATA_COLOURED-BODY PORCELAIN STONEWARE	9,5/10,5 mm	NORTH CAPE	legno_wood	321
<b>H</b>					
HANGAR naturale	GRES PORCELLANATO LAMINATO_LAMINATED PORCELAIN STONEWARE	6 mm			
	GRES PORCELLANATO A MASSA COLORATA_COLOURED-BODY PORCELAIN STONEWARE	9,5 mm	CONTEXT	cemento_concrete	177
HANGAR strutturato		9,5/20 mm			
HAZEL naturale		9/9,5 mm	MEMORY MOOD	cemento_concrete	205
HAZEL strutturato	GRES PORCELLANATO A MASSA COLORATA_COLOURED-BODY PORCELAIN STONEWARE	20 mm			
HEDGE	GRES PORCELLANATO LAMINATO_LAMINATED PORCELAIN STONEWARE	3,5 mm	GLAM	cromatico_chromatic	379
HOLLOW naturale	GRES PORCELLANATO LAMINATO_LAMINATED PORCELAIN STONEWARE	6 mm	STONE TRACE	pietra_stone	155
<b>I</b>					
INARI naturale		9,5/10,5 mm			
INARI ext	GRES PORCELLANATO A MASSA COLORATA_COLOURED-BODY PORCELAIN STONEWARE	9,5 mm	BOREALIS	legno_wood	303
INARI strutturato		20 mm			
IVORY	RIVESTIMENTO MONOPOROSA IN PASTA BIANCA SMALTATA_GLAZED WHITE BODY POROUS SINGLE-FIRED WALL TILES	10,5 mm	EVEN	cromatico_chromatic	359
<b>K</b>					
KEEN naturale	GRES PORCELLANATO A MASSA COLORATA_COLOURED-BODY PORCELAIN STONEWARE	9/9,5 mm	MEMORY MOOD	cemento_concrete	205
<b>L</b>					
LAND naturale	GRES PORCELLANATO SMALTATO_GLAZED PORCELAIN STONEWARE	9,5 mm	MOTION Linea Fiordo	cemento_concrete	215
LEAF	RIVESTIMENTO MONOPOROSA IN PASTA BIANCA SMALTATA_GLAZED WHITE BODY POROUS SINGLE-FIRED WALL TILES	10,5 mm	EVEN	cromatico_chromatic	359
LIME naturale	GRES PORCELLANATO LAMINATO_LAMINATED PORCELAIN STONEWARE	3,5 mm	URBANATURE	cemento_concrete	241
	GRES PORCELLANATO A MASSA COLORATA_COLOURED-BODY PORCELAIN STONEWARE	9,5 mm			
LOFT naturale	GRES PORCELLANATO LAMINATO_LAMINATED PORCELAIN STONEWARE	6 mm			
		9,5 mm	CONTEXT	cemento_concrete	177
LOFT ext	GRES PORCELLANATO A MASSA COLORATA_COLOURED-BODY PORCELAIN STONEWARE	9,5 mm			
LOFT strutturato		9,5/20 mm			
<b>M</b>					
MANSION naturale	GRES PORCELLANATO LAMINATO_LAMINATED PORCELAIN STONEWARE	6 mm			
		9,5 mm	CONTEXT	cemento_concrete	177
MANSION ext	GRES PORCELLANATO A MASSA COLORATA_COLOURED-BODY PORCELAIN STONEWARE	9,5 mm			
MANSION strutturato		9,5/20 mm			

# Indice alfabetico dei prodotti

List of products in alphabetical order\_Alphabetisches verzeichnis der Produkte\_Index alphabétique des produits

PRODOTTO PRODUCT PRODUKT PRODUIT	TECNOLOGIA TECHNOLOGY TECHNOLOGIE	SPESSORE THICKNESS STÄRKE ÉPAISSEUR	SERIE SERIES SÉRIE	EFFETTO LOOK OPTIK EFFET	PAGINA PAGE SEITE PAGE
MARQUINA BLACK lux	GRES PORCELLANATO LAMINATO_LAMINATED PORCELAIN STONEWARE	6 mm	ETERNITY	marmo_marble	261
	GRES PORCELLANATO A MASSA COLORATA_COLOURED-BODY PORCELAIN STONEWARE	9,5 mm			
MARQUINA BLACK soft	GRES PORCELLANATO LAMINATO_LAMINATED PORCELAIN STONEWARE	6 mm	ETERNITY	marmo_marble	261
	GRES PORCELLANATO A MASSA COLORATA_COLOURED-BODY PORCELAIN STONEWARE	9,5 mm			
MASO naturale	GRES PORCELLANATO A MASSA COLORATA_COLOURED-BODY PORCELAIN STONEWARE	9,5 mm	ASSI D'ALPE	legno_wood	291
MID naturale	GRES PORCELLANATO SMALTATO_GLAZED PORCELAIN STONEWARE	9,5 mm	MOTION Linea Fiordo	cemento_concrete	215
MIEL naturale	GRES PORCELLANATO A MASSA COLORATA_COLOURED-BODY PORCELAIN STONEWARE	9,5/10,5 mm	NUANCE	legno_wood	333
MIEL strutturato	GRES PORCELLANATO A MASSA COLORATA_COLOURED-BODY PORCELAIN STONEWARE	9,5/20 mm			
MINT	RIVESTIMENTO MONOPOROSA IN PASTA BIANCA SMALTATA_GLAZED WHITE BODY POROUS SINGLE-FIRED WALL TILES	10,5 mm	WALLCRAFT	chromatico_chromatic	401
MIRIUM naturale	GRES PORCELLANATO A MASSA COLORATA_COLOURED-BODY PORCELAIN STONEWARE	10 mm	PETRA SOLIS	pietra_stone	99
MIRIUM strutturato	GRES PORCELLANATO A MASSA COLORATA_COLOURED-BODY PORCELAIN STONEWARE	10/20 mm			
MISTIC	GRES PORCELLANATO LAMINATO_LAMINATED PORCELAIN STONEWARE	3,5 mm	GLAM	chromatico_chromatic	379
MONTANA naturale	GRES PORCELLANATO SMALTATO_GLAZED PORCELAIN STONEWARE	9,5 mm	WOOD RELIVE Linea Fiordo	legno_wood	345
MOON BEIGE	RIVESTIMENTO MONOPOROSA IN PASTA BIANCA SMALTATA_GLAZED WHITE BODY POROUS SINGLE-FIRED WALL TILES	10,5 mm	TRIOLOGY	marmo_marble	277
MOON BEIGE lux	GRES PORCELLANATO LAMINATO_LAMINATED PORCELAIN STONEWARE	5,5 mm			
MOON BEIGE soft	GRES PORCELLANATO A MASSA COLORATA_COLOURED-BODY PORCELAIN STONEWARE	9,5 mm	TRIOLOGY	marmo_marble	277
	GRES PORCELLANATO LAMINATO_LAMINATED PORCELAIN STONEWARE	5,5 mm			
MUD naturale	GRES PORCELLANATO A MASSA COLORATA_COLOURED-BODY PORCELAIN STONEWARE	9,5 mm	TRACKS Linea Fiordo	pietra_stone	163
	MUD strutturato	GRES PORCELLANATO A MASSA COLORATA_COLOURED-BODY PORCELAIN STONEWARE			
<b>N</b>					
NERO PURO naturale	GRES PORCELLANATO LAMINATO_LAMINATED PORCELAIN STONEWARE	3,5 mm	EXPERIENCE	cemento_concrete	185
NIAGE naturale	GRES PORCELLANATO A MASSA COLORATA_COLOURED-BODY PORCELAIN STONEWARE	9,5 mm	PIERRE DES RÊVES	pietra_stone	113
NIAGE ext		9,5 mm			
NIAGE strutturato		12/20 mm			
<b>O</b>					
OCEAN	RIVESTIMENTO MONOPOROSA IN PASTA BIANCA SMALTATA_GLAZED WHITE BODY POROUS SINGLE-FIRED WALL TILES	10,5 mm	EVEN	chromatico_chromatic	359
ONYX LIGHT	RIVESTIMENTO MONOPOROSA IN PASTA BIANCA SMALTATA_GLAZED WHITE BODY POROUS SINGLE-FIRED WALL TILES	10,5 mm	TRIOLOGY	marmo_marble	277
ONYX LIGHT lux	GRES PORCELLANATO LAMINATO_LAMINATED PORCELAIN STONEWARE	5,5 mm			
	GRES PORCELLANATO A MASSA COLORATA_COLOURED-BODY PORCELAIN STONEWARE	9,5 mm			
ONYX LIGHT soft	GRES PORCELLANATO LAMINATO_LAMINATED PORCELAIN STONEWARE	5,5 mm	TRIOLOGY	marmo_marble	277
	GRES PORCELLANATO A MASSA COLORATA_COLOURED-BODY PORCELAIN STONEWARE	9,5 mm			
OREGON naturale	GRES PORCELLANATO SMALTATO_GLAZED PORCELAIN STONEWARE	9,5 mm	WOOD RELIVE Linea Fiordo	legno_wood	345
ORIGIN naturale	GRES PORCELLANATO A MASSA COLORATA_COLOURED-BODY PORCELAIN STONEWARE	9,5/10 mm	DISCOVER	pietra_stone	65
ORIGIN strutturato	GRES PORCELLANATO A MASSA COLORATA_COLOURED-BODY PORCELAIN STONEWARE	9/20 mm			
OUBLI naturale	GRES PORCELLANATO A MASSA COLORATA_COLOURED-BODY PORCELAIN STONEWARE	9,5 mm	PIERRE DES RÊVES	pietra_stone	113
OUBLI ext		9,5 mm			
OUBLI strutturato		12/20 mm			
<b>P</b>					
PALE naturale	GRES PORCELLANATO A MASSA COLORATA_COLOURED-BODY PORCELAIN STONEWARE	9,5 mm	TRACKS Linea Fiordo	pietra_stone	163
PEAK naturale	GRES PORCELLANATO A MASSA COLORATA_COLOURED-BODY PORCELAIN STONEWARE	9,5 mm	FRAME Linea Fiordo	pietra_stone	77
PEAK strutturato		9,5/20 mm			
PERLE naturale	GRES PORCELLANATO A MASSA COLORATA_COLOURED-BODY PORCELAIN STONEWARE	9,5/10,5 mm	NUANCE	legno_wood	333
PERLE strutturato	GRES PORCELLANATO A MASSA COLORATA_COLOURED-BODY PORCELAIN STONEWARE	9,5 mm			
PLAN naturale	GRES PORCELLANATO A MASSA COLORATA_COLOURED-BODY PORCELAIN STONEWARE	9,5/10 mm	DISCOVER	pietra_stone	65
PLAN strutturato	GRES PORCELLANATO A MASSA COLORATA_COLOURED-BODY PORCELAIN STONEWARE	9 mm			
PORTLAND naturale	GRES PORCELLANATO LAMINATO_LAMINATED PORCELAIN STONEWARE	3,5 mm	URBANATURE	cemento_concrete	241
PORTLAND ext	GRES PORCELLANATO A MASSA COLORATA_COLOURED-BODY PORCELAIN STONEWARE	9,5 mm			
		9,5 mm			
PORTLAND strutturato	GRES PORCELLANATO A MASSA COLORATA_COLOURED-BODY PORCELAIN STONEWARE	20 mm			
<b>R</b>					
R-GOLD naturale	GRES PORCELLANATO A MASSA COLORATA_COLOURED-BODY PORCELAIN STONEWARE	10 mm	ROCK STYLE Linea Fiordo	pietra_stone	142
R-ROYAL naturale	GRES PORCELLANATO SMALTATO_GLAZED PORCELAIN STONEWARE	10 mm			
R-SILVER naturale	GRES PORCELLANATO A MASSA COLORATA_COLOURED-BODY PORCELAIN STONEWARE	10 mm	ROCK STYLE Linea Fiordo	pietra_stone	142
RAINFOREST	GRES PORCELLANATO LAMINATO_LAMINATED PORCELAIN STONEWARE	3,5 mm			
REFLEX	GRES PORCELLANATO LAMINATO_LAMINATED PORCELAIN STONEWARE	3,5 mm	GLAM	chromatico_chromatic	379
REISA naturale	GRES PORCELLANATO A MASSA COLORATA_COLOURED-BODY PORCELAIN STONEWARE	9,5/10,5 mm	NORTH CAPE	legno_wood	321
RELIC	GRES PORCELLANATO LAMINATO_LAMINATED PORCELAIN STONEWARE	3,5 mm	GLAM	chromatico_chromatic	379
REVELLE naturale	GRES PORCELLANATO A MASSA COLORATA_COLOURED-BODY PORCELAIN STONEWARE	9,5 mm	PIERRE DES RÊVES	pietra_stone	113
REVELLE ext		9,5 mm			
REVELLE strutturato		20 mm			
RIVER naturale	GRES PORCELLANATO A MASSA COLORATA_COLOURED-BODY PORCELAIN STONEWARE	9,5 mm	FRAME Linea Fiordo	pietra_stone	77
RIVER strutturato	GRES PORCELLANATO A MASSA COLORATA_COLOURED-BODY PORCELAIN STONEWARE	9,5/20 mm			
RONDANE naturale	GRES PORCELLANATO A MASSA COLORATA_COLOURED-BODY PORCELAIN STONEWARE	9,5/10,5 mm	NORTH CAPE	legno_wood	321
ROOT naturale	GRES PORCELLANATO A MASSA COLORATA_COLOURED-BODY PORCELAIN STONEWARE	9,5 mm	GENESIS Linea Fiordo	cemento_concrete	193
ROSSO MISTO strutturato	GRES PORCELLANATO TUTTA MASSA_FULL-BODY PORCELAIN STONEWARE	9 mm	PIETRE DI FANES	pietra_stone	121
<b>S</b>					
SAND PRIME naturale	GRES PORCELLANATO LAMINATO_LAMINATED PORCELAIN STONEWARE	5,5 mm	PRIME STONE	pietra_stone	133
SAND PRIME soft	GRES PORCELLANATO LAMINATO_LAMINATED PORCELAIN STONEWARE	9,5 mm			
SAND PRIME lux	GRES PORCELLANATO A MASSA COLORATA_COLOURED-BODY PORCELAIN STONEWARE	9,5 mm			
SAND PRIME strutturato	GRES PORCELLANATO A MASSA COLORATA_COLOURED-BODY PORCELAIN STONEWARE	9,5/20 mm			
SANDY GREY	RIVESTIMENTO MONOPOROSA IN PASTA BIANCA SMALTATA_GLAZED WHITE BODY POROUS SINGLE-FIRED WALL TILES	10,5 mm	TRIOLOGY	marmo_marble	277
SANDY GREY lux	GRES PORCELLANATO LAMINATO_LAMINATED PORCELAIN STONEWARE	5,5 mm			
	GRES PORCELLANATO A MASSA COLORATA_COLOURED-BODY PORCELAIN STONEWARE	9,5 mm			
	GRES PORCELLANATO LAMINATO_LAMINATED PORCELAIN STONEWARE	5,5 mm			
SANDY GREY soft	GRES PORCELLANATO A MASSA COLORATA_COLOURED-BODY PORCELAIN STONEWARE	9,5 mm	TRIOLOGY	marmo_marble	277
SHAPES	GRES PORCELLANATO LAMINATO_LAMINATED PORCELAIN STONEWARE	3,5 mm			
	GRES PORCELLANATO A MASSA COLORATA_COLOURED-BODY PORCELAIN STONEWARE	9/9,5 mm			
SHEER naturale	GRES PORCELLANATO A MASSA COLORATA_COLOURED-BODY PORCELAIN STONEWARE	9/9,5 mm	MEMORY MOOD	cemento_concrete	205

PRODOTTO PRODUCT PRODUKT PRODUIT	TECNOLOGIA TECHNOLOGY TECHNOLOGIE	SPESSORE THICKNESS STÄRKE ÉPAISSEUR	SERIE SERIES SÉRIE	EFFETTO LOOK OPTIK EFFET	PAGINA PAGE SEITE PAGE
SILICON naturale	GRES PORCELLANATO LAMINATO_LAMINATED PORCELAIN STONEWARE	3,5 mm	URBANATURE	cemento_concrete	241
	GRES PORCELLANATO A MASSA COLORATA_COLOURED-BODY PORCELAIN STONEWARE	9,5 mm			
SILVER PRIME naturale	GRES PORCELLANATO LAMINATO_LAMINATED PORCELAIN STONEWARE	5,5 mm	PRIME STONE	pietra_stone	133
SILVER PRIME soft	GRES PORCELLANATO LAMINATO_LAMINATED PORCELAIN STONEWARE	9,5 mm			
SILVER PRIME lux	GRES PORCELLANATO A MASSA COLORATA_COLOURED-BODY PORCELAIN STONEWARE	9,5 mm			
SILVER PRIME strutturato	GRES PORCELLANATO A MASSA COLORATA_COLOURED-BODY PORCELAIN STONEWARE	9,5/20 mm			
SKY naturale	GRES PORCELLANATO A MASSA COLORATA_COLOURED-BODY PORCELAIN STONEWARE	9,5 mm	HORIZON	pietra_stone	89
SKY SMOKE lux	GRES PORCELLANATO LAMINATO_LAMINATED PORCELAIN STONEWARE	5,5 mm	TRIOLOGY	marmo_marble	277
	GRES PORCELLANATO A MASSA COLORATA_COLOURED-BODY PORCELAIN STONEWARE	9,5 mm			
SKY SMOKE soft	GRES PORCELLANATO LAMINATO_LAMINATED PORCELAIN STONEWARE	5,5 mm			
	GRES PORCELLANATO A MASSA COLORATA_COLOURED-BODY PORCELAIN STONEWARE	9,5 mm			
SNOW	RIVESTIMENTO MONOPOROSA IN PASTA BIANCA SMALTATA_GLAZED WHITE BODY POROUS SINGLE-FIRED WALL TILES	10,5 mm	EVEN	chromatico_chromatic	359
SOIL naturale	GRES PORCELLANATO A MASSA COLORATA_COLOURED-BODY PORCELAIN STONEWARE	9,5 mm	TRACKS Linea Fiordo	pietra_stone	163
SOIL strutturato	GRES PORCELLANATO A MASSA COLORATA_COLOURED-BODY PORCELAIN STONEWARE	20 mm			
SOMNIUM naturale	GRES PORCELLANATO A MASSA COLORATA_COLOURED-BODY PORCELAIN STONEWARE	10 mm	PETRA SOLIS	pietra_stone	99
SOMNIUM strutturato	GRES PORCELLANATO A MASSA COLORATA_COLOURED-BODY PORCELAIN STONEWARE	10/20 mm			
SOUL naturale	GRES PORCELLANATO A MASSA COLORATA_COLOURED-BODY PORCELAIN STONEWARE	9,5 mm	GENESIS Linea Fiordo	cemento_concrete	193
SPRING	RIVESTIMENTO MONOPOROSA IN PASTA BIANCA SMALTATA_GLAZED WHITE BODY POROUS SINGLE-FIRED WALL TILES	10,5 mm	WALLCRAFT	chromatico_chromatic	401
SQUARE naturale	GRES PORCELLANATO LAMINATO_LAMINATED PORCELAIN STONEWARE	6 mm	CONTEXT	cemento_concrete	177
	GRES PORCELLANATO A MASSA COLORATA_COLOURED-BODY PORCELAIN STONEWARE	9,5 mm			
SQUARE ext	GRES PORCELLANATO A MASSA COLORATA_COLOURED-BODY PORCELAIN STONEWARE	9,5 mm			
SQUARE strutturato	GRES PORCELLANATO A MASSA COLORATA_COLOURED-BODY PORCELAIN STONEWARE	9,5/20 mm			
STATUARIO WHITE lux	GRES PORCELLANATO LAMINATO_LAMINATED PORCELAIN STONEWARE	6 mm	ETERNITY	marmo_marble	261
	GRES PORCELLANATO A MASSA COLORATA_COLOURED-BODY PORCELAIN STONEWARE	9,5 mm			
	GRES PORCELLANATO LAMINATO_LAMINATED PORCELAIN STONEWARE	6 mm			
STATUARIO WHITE soft	GRES PORCELLANATO A MASSA COLORATA_COLOURED-BODY PORCELAIN STONEWARE	9,5 mm	ETERNITY	marmo_marble	261
	GRES PORCELLANATO LAMINATO_LAMINATED PORCELAIN STONEWARE	6 mm			
STORE naturale	GRES PORCELLANATO LAMINATO_LAMINATED PORCELAIN STONEWARE	6 mm	CONTEXT	cemento_concrete	177
	GRES PORCELLANATO A MASSA COLORATA_COLOURED-BODY PORCELAIN STONEWARE	9,5 mm			
STORE strutturato	GRES PORCELLANATO A MASSA COLORATA_COLOURED-BODY PORCELAIN STONEWARE	9,5/20 mm			
STORE strutturato	GRES PORCELLANATO A MASSA COLORATA_COLOURED-BODY PORCELAIN STONEWARE	9,5/20 mm			
STORM naturale	GRES PORCELLANATO A MASSA COLORATA_COLOURED-BODY PORCELAIN STONEWARE	9,5 mm	HORIZON	pietra_stone	89
STORM strutturato	GRES PORCELLANATO A MASSA COLORATA_COLOURED-BODY PORCELAIN STONEWARE	9,5/20 mm			
STUBE naturale	GRES PORCELLANATO A MASSA COLORATA_COLOURED-BODY PORCELAIN STONEWARE	9,5 mm	ASSI D'ALPE	legno_wood	291
SUN naturale	GRES PORCELLANATO A MASSA COLORATA_COLOURED-BODY PORCELAIN STONEWARE	9,5/10 mm	DISCOVER	pietra_stone	65
SUN strutturato	GRES PORCELLANATO A MASSA COLORATA_COLOURED-BODY PORCELAIN STONEWARE	9/20 mm			
SUNRISE naturale	GRES PORCELLANATO A MASSA COLORATA_COLOURED-BODY PORCELAIN STONEWARE	9,5 mm	HORIZON	pietra_stone	89
SUNRISE strutturato		9,5/20 mm			
SUNSET naturale		9,5 mm			
SUNSET strutturato		9,5/20 mm			
<b>T</b>					
TABAC naturale	GRES PORCELLANATO A MASSA COLORATA_COLOURED-BODY PORCELAIN STONEWARE	9,5/10,5 mm	NUANCE	legno_wood	333
TABAC strutturato	GRES PORCELLANATO A MASSA COLORATA_COLOURED-BODY PORCELAIN STONEWARE	9,5/20 mm			
TAN	RIVESTIMENTO MONOPOROSA IN PASTA BIANCA SMALTATA_GLAZED WHITE BODY POROUS SINGLE-FIRED WALL TILES	10,5 mm	WALLCRAFT	chromatico_chromatic	401
TARTAN BEIGE	GRES PORCELLANATO LAMINATO_LAMINATED PORCELAIN STONEWARE	3,5 mm	GLAM	chromatico_chromatic	379
TARTAN MAUVE	GRES PORCELLANATO LAMINATO_LAMINATED PORCELAIN STONEWARE	3,5 mm	GLAM	chromatico_chromatic	379
TERRA naturale	GRES PORCELLANATO A MASSA COLORATA_COLOURED-BODY PORCELAIN STONEWARE	8/9,5 mm	OPIFICIO 22/A	cemento_concrete	227
TERRA ext		9,5 mm			
TERRA strutturato		20 mm			
<b>V</b>					
VANILLA	RIVESTIMENTO MONOPOROSA IN PASTA BIANCA SMALTATA_GLAZED WHITE BODY POROUS SINGLE-FIRED WALL TILES	10,5 mm	WALLCRAFT	chromatico_chromatic	401
VIBES	GRES PORCELLANATO LAMINATO_LAMINATED PORCELAIN STONEWARE	3,5 mm	GLAM	chromatico_chromatic	379
<b>W</b>					
WASHI	GRES PORCELLANATO LAMINATO_LAMINATED PORCELAIN STONEWARE	3,5 mm	GLAM	chromatico_chromatic	379
WAVE	RIVESTIMENTO MONOPOROSA IN PASTA BIANCA SMALTATA_GLAZED WHITE BODY POROUS SINGLE-FIRED WALL TILES	10,5 mm	WALLCRAFT	chromatico_chromatic	401
WAX	RIVESTIMENTO MONOPOROSA IN PASTA BIANCA SMALTATA_GLAZED WHITE BODY POROUS SINGLE-FIRED WALL TILES	10,5 mm	WALLCRAFT	chromatico_chromatic	401
WHITE naturale	GRES PORCELLANATO A MASSA COLORATA_COLOURED-BODY PORCELAIN STONEWARE	9,5/10 mm	DISCOVER	pietra_stone	65
WHITE strutturato	GRES PORCELLANATO A MASSA COLORATA_COLOURED-BODY PORCELAIN STONEWARE	9/20 mm			
WHITE PRIME naturale	GRES PORCELLANATO LAMINATO_LAMINATED PORCELAIN STONEWARE	5,5 mm	PRIME STONE	pietra_stone	133
WHITE PRIME soft	GRES PORCELLANATO LAMINATO_LAMINATED PORCELAIN STONEWARE	9,5 mm			
WHITE PRIME lux	GRES PORCELLANATO A MASSA COLORATA_COLOURED-BODY PORCELAIN STONEWARE	9,5 mm			

# Condizioni generali di vendita

General terms and conditions of sale\_Allgemeine Verkaufsbedingungen\_Conditions générales de vente

## 1) Ambito di applicazione

1.1 Le presenti condizioni generali di vendita ("CGV") si applicheranno a tutte le forniture di piastrelle in ceramica o altri prodotti in ceramica ("Prodotti") che saranno eseguite nei confronti di qualsiasi cliente ("CLIENTE") da una società o divisione del Gruppo Panariagroup Industrie Ceramiche S.p.A. ("VENDITORE") anche se le CGV non verranno di volta in volta espressamente richiamate, menzionate ovvero espressamente accettate dal CLIENTE.

1.2 Accordi in deroga alle presenti CGV saranno efficaci nei confronti di VENDITORE soltanto (i) se contenuti nel "Contratto di Vendita", come definito al successivo paragrafo 3.2, (ii) se contenuti in documenti successivi alla conclusione del Contratto di Vendita ed il cui contenuto sia stato accettato per iscritto da VENDITORE. In ogni caso, anche se presenti deroghe concordate per iscritto, le CGV continueranno ad applicarsi per le parti non espressamente derogate.

1.3 In nessun caso VENDITORE sarà vincolato da eventuali condizioni generali di contratto di CLIENTE, neanche qualora esse siano richiamate o riportate negli ordini o in qualsiasi altra documentazione trasmessa a VENDITORE da CLIENTE. Nessun comportamento di VENDITORE potrà essere interpretato o utilizzato al fine di esprimere tacita accettazione di VENDITORE delle condizioni generali di contratto di CLIENTE.

1.4 In nessun caso, VENDITORE sarà vincolato da atti e/o azioni dei propri agenti, essendo questi ultimi privi del potere di vincolare il VENDITORE.

1.5 Nel caso in cui CLIENTE sia un consumatore, le disposizioni delle presenti CGV non pregiudicheranno i diritti allo stesso spettanti in base alle previsioni di legge relative alle vendite eseguite nei confronti dei consumatori.

## 2) Prodotti – Modifiche

2.1 Le rappresentazioni e/o immagini riguardanti i Prodotti riportate in siti internet, brochure, cataloghi, listini prezzi o documenti simili di VENDITORE hanno valore indicativo ed illustrativo. Allo stesso modo i campioni e modelli rappresentano solo indicativamente per peso, dimensione, capacità, rendimento, colore le caratteristiche dei Prodotti ed hanno solo carattere di indicazioni approssimative e/o di massima e non hanno valore impegnativo per VENDITORE se non nella misura in cui siano espressamente menzionati come tali nell'accettazione scritta dell'offerta da parte di VENDITORE non rappresentando il risultato estetico finale dei Prodotti. Le caratteristiche tecniche e fisiche nonché le qualità dei Prodotti sono riportate unicamente nei manuali tecnici di VENDITORE. Ogni altro documento riportante le caratteristiche tecniche e fisiche nonché le qualità dei Prodotti ha valore puramente indicativo e non sarà vincolante per VENDITORE.

2.2 VENDITORE dichiara che i Prodotti sono conformi alle norme italiane e comunitarie di settore ad essi applicabili. A pena di inefficacia della garanzia di cui all'articolo 7 e di qualsiasi altra garanzia convenzionale e/o legale, ciascun Prodotto dovrà essere utilizzato ed applicato in conformità alle indicazioni di utilizzo di VENDITORE riferite ai Prodotti in questione e riportate nei cataloghi e/o nei manuali tecnici di VENDITORE ovvero diversamente comunicate o rese accessibili da VENDITORE a CLIENTE e, comunque, in conformità alla diligenza richiesta dalla natura dei Prodotti stessi.

2.3 È responsabilità di CLIENTE, prima della conclusione del Contratto di Vendita, accertare che i Prodotti siano idonei allo scopo e/o all'uso specifico per il quale intende acquistarli e, inoltre, accertare che i Prodotti medesimi siano conformi alla normativa applicabile nel luogo in cui CLIENTE intende importarli, distribuirli, venderli o farne qualsiasi uso.

2.4 VENDITORE, anche dopo la conclusione del Contratto di Vendita, potrà apportare ai Prodotti qualsiasi modifica che esso ritenga necessaria o opportuna, purché non ne alteri le caratteristiche essenziali. Qualora VENDITORE esegua modifiche sostanziali ai Prodotti (ad es. modifiche che interessano: le modalità di installazione, le caratteristiche di intercambiabilità dei Prodotti ecc.) oggetto di un Contratto di Vendita (come definito al successivo paragrafo 3.2), VENDITORE comunicherà per iscritto tale modifica a CLIENTE.

2.5 CLIENTE sarà tenuto a rappresentare agli acquirenti dei Prodotti e ai terzi le caratteristiche dei Prodotti nonché le indicazioni d'uso e di applicazione degli stessi, in conformità a quanto rappresentatogli da VENDITORE. Fermo restando quanto sopra, CLIENTE sarà esclusivamente responsabile per le dichiarazioni effettuate nei confronti dei terzi in relazione ai Prodotti, alle loro caratteristiche e al loro uso e/o applicazione e dovrà tenere VENDITORE indenne e manlevato da qualsiasi danno eventualmente subito da VENDITORE in relazione a o in connessione con tali dichiarazioni di CLIENTE, nel caso in cui le stesse siano false, incomplete e/o inesatte.

## 3) Preventivi – Conclusione del Contratto di Vendita - Tolleranze

3.1 I preventivi, verbali o scritti, di VENDITORE non costituiscono proposte contrattuali.

3.2 Il contratto di vendita ("Contratto di Vendita") si perfezionerà attraverso: a) la trasmissione della offerta da parte di VENDITORE e l'accettazione scritta di tale offerta da parte di CLIENTE senza alcuna modifica all'offerta stessa; oppure b) la trasmissione dell'ordine da parte di CLIENTE e l'accettazione scritta di tale ordine da parte di VENDITORE.

3.3 Ai fini del precedente paragrafo 3.2, lettera a) i seguenti fatti o atti avranno valore di accettazione scritta della offerta di VENDITORE da parte di CLIENTE:

a) ricezione e accettazione, da parte di VENDITORE, di una lettera di credito procurata da CLIENTE;

b) ricezione e accettazione, da parte di VENDITORE, di tutto o di parte del prezzo della fornitura;

c) ricezione, da parte di VENDITORE, di un ordine di acquisto emesso da CLIENTE. In tal caso, qualsiasi previsione dell'ordine di acquisto di CLIENTE che risulti difforme dalle previsioni della offerta di VENDITORE sarà vincolante nei confronti di VENDITORE solo se specificamente accettata per iscritto da quest'ultimo.

3.4 Inoltre, ai fini del precedente paragrafo 3.2, lettera b), nel caso in cui la accettazione di VENDITORE dell'ordine di CLIENTE contenga condizioni differenti rispetto all'ordine formulato da CLIENTE, il Contratto di Vendita si considererà concluso alle condizioni riportate nella conferma d'ordine di VENDITORE, salvo il caso in cui CLIENTE comunichi per iscritto di rifiutare le modifiche riportate nella accettazione dell'ordine di VENDITORE entro 1 (uno) giorno lavorativo dalla ricezione della stessa.

3.5 Le forniture comprenderanno esclusivamente quanto indicato nel Contratto di

Vendita.

3.6 CLIENTE riconosce a VENDITORE i margini di tolleranza quantitativa e/o qualitativa rinvenibili dal Contratto di Vendita o dagli usi o dalla prassi del settore dei Prodotti.

## 4) Imballaggio – Termini di resa – Termini di consegna

4.1 I Prodotti saranno imballati ed approntati per la spedizione secondo i sistemi di protezione generalmente adottati da VENDITORE per i Prodotti in questione in considerazione delle modalità di trasporto convenute. Qualora CLIENTE ritenga necessario l'impiego di imballaggi speciali o di protezioni aggiuntive dovrà farne esplicita richiesta a VENDITORE, fermo restando che, in tal caso, saranno a carico di CLIENTE tutti i relativi costi.

4.2 Salvo diversamente previsto nel Contratto di Vendita, i Prodotti saranno consegnati a CLIENTE in conformità alla regola Incoterms® ICC, ultima versione, Ex-Works (EXW) – stabilimento di VENDITORE indicato nel Contratto di Vendita. CLIENTE autorizza VENDITORE a sottoscrivere, in nome e per conto di CLIENTE, tutti i documenti che debbano essere sottoscritti al momento della presa in carico dei Prodotti presso gli stabilimenti di VENDITORE, come, ad esempio, il CMR. Nel caso in cui la regola Incoterms® ICC concordata tra le parti preveda che CLIENTE debba curare il trasporto dei Prodotti fuori dall'Italia:

a) in caso di cessione intra-comunitaria, entro 45 (quarantacinque) giorni dalla ricezione dei Prodotti presso gli stabilimenti di CLIENTE, CLIENTE dovrà trasmettere a VENDITORE un originale o una copia del documento di trasporto internazionale CMR o di altro documento di trasporto, sottoscritti a destinazione da CLIENTE ovvero, in assenza del CMR, una dichiarazione di ricezione dei Prodotti, emessa sulla base del form quale Allegato -1- disponibile per il download all'indirizzo [www.panariagroup.it](http://www.panariagroup.it);

b) in caso di cessione extra-comunitaria, CLIENTE si impegna a: i) presentare la dichiarazione doganale di esportazione (DAU-EX e DAE) ed effettuare l'appuntamento del MRN (Movement Reference Number) presso la dogana del territorio comunitario di uscita dei Prodotti, entro 90 (novanta) giorni dalla data di consegna in Italia dei Prodotti stessi;

ii) inviare a VENDITORE, entro 90 (novanta) giorni dalla data di consegna, i documenti comprovanti l'esportazione dei Prodotti (dichiarazione di esportazione DAU-EX + DAE + notifica di avvenuta esportazione);

iii) confermare prontamente per iscritto a VENDITORE l'avvenuta esecuzione delle suddette formalità e a fornirgli ogni ulteriore documento comprovante l'esecuzione delle suddette formalità e l'uscita dei Prodotti dal territorio dell'Unione Europea. In caso di inadempienza di CLIENTE a quanto pattuito al presente paragrafo 4.2, VENDITORE avrà il diritto di addebitare immediatamente a CLIENTE l'imposta sul Valore Aggiunto relativa alla fornitura e connessa alla mancata prova del trasporto dei Prodotti in altro Stato Membro della Comunità Europea o mancato appuramento della esportazione. In ogni caso, CLIENTE terrà indenne e manlevato VENDITORE in relazione al pagamento di tutto quanto eventualmente dovuto da VENDITORE nei confronti dell'Amministrazione Finanziaria, a titolo di sanzioni ed interessi o ad altro titolo, in connessione con la fornitura e la mancata prova del trasporto dei Prodotti in altro Stato Membro della Comunità Europea o al mancato appuramento della esportazione.

A tal proposito, VENDITORE potrà: (i) compensare qualsiasi importo dovuto da CLIENTE in base al presente paragrafo 4.2 con eventuali crediti maturati da CLIENTE, a qualsiasi titolo, nei confronti di VENDITORE; ovvero (ii) trattenere definitivamente eventuali somme già ricevute da CLIENTE in relazione a Contratti di Vendita ancora da eseguirsi, effettuando una compensazione fra il debito di CLIENTE in base al presente paragrafo 4.2 e tutti i pagamenti già eseguiti da CLIENTE.

4.3 VENDITORE eseguirà la consegna dei Prodotti entro il termine previsto nel Contratto di Vendita, anche mediante consegne parziali. Il termine di consegna si intenderà in ogni caso non essenziale né perentorio. Salvo il caso di dolo o colpa grave, VENDITORE non sarà tenuto a corrispondere a CLIENTE alcun indennizzo o risarcimento per eventuali danni diretti o indiretti dovuti al ritardo nella consegna. In nessun caso di ritardo nella consegna dei Prodotti CLIENTE avrà il diritto di risolvere il Contratto di Vendita.

4.4 Al momento della ricezione dei Prodotti, CLIENTE avrà l'onere di denunciare danneggiamenti agli imballi e/o eventuali avarie o ammanchi di Prodotti verificatisi durante il trasporto, mediante apposizione di riserva scritta nel documento di trasporto, nonché l'onere di:

a) far confermare dal vettore, mediate apposita sottoscrizione, l'apposizione della riserva; e

b) informare immediatamente per iscritto VENDITORE e inviargli copia del suddetto documento entro e non oltre 8 (otto) giorni dalla data di ricezione dei Prodotti. In caso contrario, VENDITORE non sarà responsabile per eventuali danneggiamenti, perdite o furti occorsi ai Prodotti durante il trasporto, anche qualora lo stesso sia eseguito con rischio in tutto o in parte a carico di VENDITORE.

## 5) Prezzi – Pagamento – Ritardato pagamento

5.1 I Prodotti verranno forniti ai prezzi concordati tra le parti nel Contratto di Vendita o, qualora il Contratto di Vendita non dovesse menzionare alcun prezzo, ai prezzi riportati nel listino prezzi di VENDITORE in vigore al momento della conclusione del Contratto di Vendita. Salvo diversa indicazione scritta, i prezzi dei Prodotti riportati nei listini, nei preventivi e/o nelle offerte di VENDITORE si intendono in Euro, al netto di IVA e per consegne eseguite in conformità alla regola Incoterms® Ex-Works (EXW), stabilimento di VENDITORE indicato nel Contratto di Vendita, ICC, ultima versione. Pertanto, nel caso in cui venga convenuto un diverso termine di resa, l'importo della fattura verrà modificato di conseguenza, includendo in fattura le spese di trasporto e ogni altro onere connesso con il termine di resa concordato tra le parti per la consegna dei Prodotti.

5.2 Il pagamento dei Prodotti dovrà essere eseguito da CLIENTE con le modalità e nei tempi indicati nel Contratto di Vendita o diversamente concordati per iscritto tra le parti. I pagamenti si considereranno effettuati da CLIENTE solo nel momento in cui il relativo importo sarà stato accreditato sul conto corrente di VENDITORE. Il pagamento dovrà essere effettuato da CLIENTE in Euro ovvero nella valuta del luogo in cui CLIENTE ha la propria sede, a scelta di VENDITORE, in conformità alla valuta che VENDITORE indicherà nella relativa fattura di vendita.

5.3 Nel caso in cui CLIENTE sia in ritardo nell'esecuzione del pagamento, VENDITORE avrà diritto:

a) al pagamento degli interessi legali di mora, in conformità alla legge applicabile;

b) di sospendere le consegne ancora da eseguirsi, previa comunicazione scritta a CLIENTE, fino a quando gli importi dovuti e i relativi interessi di mora siano stati integralmente pagati.

5.4 Qualora tali importi e interessi risultino ancora non pagati una volta decorsi 30 (trenta) giorni dalla scadenza data di pagamento concordata, VENDITORE potrà altresì, a propria discrezione, alternativamente o cumulativamente, e in aggiunta a qualsiasi altro diritto o rimedio allo stesso spettante in base alla legge o alle presenti CGV:

a) esigere l'immediato pagamento di ogni debito residuo, anche se sia stato convenuto un pagamento a rate o un pagamento dilazionato e/o siano stati emessi e siano in scadenza cambiali tratte, pagherò cambiari, assegni o altri strumenti di pagamento;

b) risolvere il Contratto di Vendita in questione e trattenere definitivamente eventuali somme già ricevute in relazione a tale Contratto di Vendita e/o ad altri Contratti di Vendita, effettuando una compensazione fra il debito di CLIENTE e tutti i pagamenti ricevuti;

c) eseguire le future consegne dei Prodotti soltanto previo pagamento anticipato in relazione alle forniture ancora da eseguirsi;

d) revocare sconti e bonus che siano stati concordati fra le parti anche in relazione a Contratti di Vendita regolarmente eseguiti.

5.5 I diritti di cui ai precedenti paragrafi 5.3 e 5.4 potranno essere esercitati in qualsiasi momento da VENDITORE anche nel caso in cui:

a) CLIENTE sia sottoposto a liquidazione, a procedure concorsuali, fallimentari, di ristrutturazione del debito o ad azioni esecutive; oppure

b) la compagnia assicurativa di VENDITORE rifiuti la copertura assicurativa di crediti di VENDITORE nei confronti di CLIENTE; oppure

c) CLIENTE versi in uno stato di difficoltà finanziaria - idoneo a determinare un pregiudizio al puntuale adempimento dei propri obblighi di pagamento - risultante, a titolo esemplificativo e non esaustivo, dalla levata di protesti, dalla diminuzione di garanzie concesse e/o dalla mancata prestazione di garanzie promesse, nonché dal verificarsi di qualsiasi insoluto, anche qualora tali circostanze si siano verificate nell'ambito dei rapporti tra CLIENTE ed altri suoi fornitori.

5.6 CLIENTE non potrà far valere eventuali inadempimenti di VENDITORE né potrà avviare alcuna azione legale nei confronti dello stesso fino a quando non abbia pagato integralmente a VENDITORE ogni importo allo stesso spettante ai sensi dei paragrafi 5.3 e 5.4.

## 6) Riserva di Proprietà

6.1 VENDITORE manterrà la proprietà dei Prodotti venduti fino al completo pagamento del loro prezzo da parte di CLIENTE.

Fermo restando quanto sopra, il rischio di perimento dei Prodotti sarà disciplinato dal termine di resa Incoterms® concordato tra le parti per la consegna dei Prodotti.

6.2 In caso di inadempimento o ritardo nell'adempimento dell'obbligo di pagare il prezzo dei Prodotti, fermo restando quanto previsto ai precedenti paragrafi 5.4, 5.5 e 5.6, VENDITORE avrà il diritto di accedere ai locali in cui si trovano i Prodotti, di rientrarne in possesso e di incamerare definitivamente, a titolo di penale, eventuali somme pagate da CLIENTE per i Prodotti in questione.

## 7) Garanzia

7.1 Fatto salvo quanto previsto ai precedenti paragrafi 2.1, 2.2, 2.4 e 3.6 in relazione alle modifiche ammesse ai Prodotti e alle tolleranze, VENDITORE garantisce a CLIENTE che i Prodotti saranno conformi al Contratto di Vendita, alla classificazione indicata nei manuali tecnici, cataloghi e/o listini prezzi di VENDITORE nonché privi di difetti di fabbricazione. La presente garanzia avrà la durata di 12 (dodici) mesi dalla data di ritiro dei Prodotti dallo stabilimento di VENDITORE, a prescindere dal termine di resa Incoterms® concordato.

7.2 Sono esclusi da qualsiasi garanzia:

a) le alterazioni cromatiche e le differenze di tonalità dei Prodotti;

b) i Prodotti classificati nel Contratto di Vendita come di qualità inferiore alla prima scelta ovvero come partite di Prodotti di fine serie venduta in blocco ovvero come partite speciali;

c) i Prodotti non posati a regola d'arte e/o posati in modo difforme rispetto alle previsioni delle norme di settore applicabili;

d) i Prodotti applicati su superfici e/o in ambienti diversi da quelli consigliati da VENDITORE;

e) i Prodotti utilizzati in modo difforme rispetto alle istruzioni e/o indicazioni di VENDITORE incluse nei cataloghi e/o i listini di VENDITORE ovvero in altro modo comunicate a CLIENTE da VENDITORE ivi incluse le indicazioni di cui al precedente paragrafo 2.2;

f) i Prodotti utilizzati in modo non conforme alla normale diligenza e/o alla tecnica richieste dalla natura dei Prodotti stessi;

g) l'ingelività del Prodotto, a meno che tale caratteristica del Prodotto non sia stata dichiarata da VENDITORE nel manuale tecnico, in riferimento al Prodotto in questione;

h) caratteristiche dei Prodotti come risultanti dalla classificazione del materiale ceramico (i) eseguita da parte di organismi di controllo e/o certificazione diversi da quelli di Paesi dell'Unione Europea e/o (ii) effettuata sulla base di criteri che non corrispondano a quelli utilizzati da VENDITORE.

7.3 Fermo quanto previsto al precedente paragrafo 4.4, CLIENTE sarà tenuto ad esaminare i Prodotti nel più breve tempo possibile e, a pena di decadenza dalla presente garanzia, a denunciare per iscritto a VENDITORE, a mezzo fax o email:

a) difformità relative alla tipologia e/o alla quantità dei Prodotti ricevuti nonché altre difformità palesi dei Prodotti o loro difetti palesi: entro e non oltre 8 (otto) giorni dalla consegna dei Prodotti e, comunque, prima della posa in opera dei Prodotti;

b) difformità occulte o difetti occulti dei Prodotti: entro e non oltre 8 (otto) giorni dalla scoperta e, comunque, entro il periodo di garanzia.

7.4 VENDITORE avrà il diritto di verificare i Prodotti, o alcuni campioni dei Prodotti, che CLIENTE ritenga essere difformi o difettosi, anche al fine di verificare il rispetto delle prescrizioni relative alla posa in opera degli stessi e/o all'applicazione e/o all'utilizzo dei Prodotti come rinvenibili dalle presenti CGV. A tale proposito, CLIENTE potrà restituire a VENDITORE i Prodotti dallo stesso ritenuti difformi o difettosi soltanto previa autorizzazione scritta di VENDITORE ed a condizione che CLIENTE si faccia integralmente carico delle spese e dei rischi di spedizione. L'autorizzazione

al reso dei Prodotti o dei campioni asseritamente difformi o difettosi non costituirà in nessun caso riconoscimento delle difformità o dei difetti da parte di VENDITORE.

7.5 Nel caso in cui i Prodotti siano riconosciuti da VENDITORE come effettivamente difformi o difettosi, CLIENTE, a scelta di VENDITORE, avrà esclusivamente diritto:

a) alla sostituzione gratuita dei Prodotti difformi o difettosi; oppure

b) all'esonero parziale o totale dal pagamento del loro prezzo, a seconda della gravità delle difformità o dei difetti.

7.6 Ai fini del paragrafo 7.5 lettera (a), i Prodotti che debbano essere consegnati in sostituzione di Prodotti difformi o difettosi saranno consegnati a CLIENTE in conformità alla regola Incoterms® 2010 ICC DDP – stabilimento di CLIENTE. I Prodotti che siano stati sostituiti dovranno essere, a scelta di VENDITORE, distrutti o smaltiti da CLIENTE, a spese di quest'ultimo, ovvero restituiti a VENDITORE, a spese di VENDITORE stesso. Per i Prodotti sostituiti che debbano essere distrutti o smaltiti da CLIENTE, CLIENTE si impegna ad inviare a VENDITORE la prova dell'avvenuta distruzione o smaltimento dei Prodotti, unitamente ai documenti giustificativi comprovanti il sostenimento dei costi di distruzione o smaltimento.

7.7 I diritti e rimedi descritti ai precedenti paragrafi 7.5 e 7.6 costituiscono i soli diritti e rimedi in garanzia concessi a CLIENTE. Nella massima misura consentita dalla legge, sono esclusi ulteriori responsabilità o obblighi di VENDITORE in relazione alla fornitura di Prodotti difformi o difettosi, ivi inclusi, a titolo esemplificativo e non esaustivo, responsabilità e obblighi per eventuali danni diretti, indiretti o consequenziali, perdite di profitto, ecc. a cui tale responsabilità si ricollega.

7.8 La presente garanzia sostituisce ed esclude ogni altra garanzia, espressa o implicita, prevista per legge o altrimenti.

## 8) Forza maggiore

8.1 VENDITORE non sarà in alcun modo responsabile per il mancato o ritardato adempimento di alcuna obbligazione relativa alla fornitura dei Prodotti qualora tale mancato o ritardato adempimento sia dovuto a eventi di forza maggiore come guerre, incendi, terremoti, inondazioni, tsunami, scioperi, difficoltà insorte con la forza lavoro, scarsità o difficoltà di approvvigionamento di materie prime, restrizioni all'uso di energia, sospensione o difficoltà nei trasporti, guasti agli impianti, atti della pubblica autorità o a qualsiasi altra azione o causa che non possa essere ragionevolmente prevista o alla quale VENDITORE non possa ragionevolmente porre rimedio tramite l'ordinaria diligenza.

8.2 In tali eventualità, il termine per l'esecuzione della fornitura verrà esteso per tutto il periodo di durata dell'evento di forza maggiore, fermo restando che, qualora tale evento dovesse impedire l'esecuzione della fornitura per oltre 6 (sei) mesi, CLIENTE avrà il diritto di risolvere il relativo contratto di vendita, mediante invio di lettera raccomandata con ricevuta di ritorno o corriere a VENDITORE, senza alcuna responsabilità o conseguenza per VENDITORE.

## 9) Invalidità di singole clausole contrattuali

L'invalidità di una disposizione delle presenti CGV non comprometterà la validità delle residue disposizioni che rimarranno pienamente valide e efficaci.

## 10) Riservatezza

10.1 CLIENTE si impegna a: (i) trattare come riservati tutte le informazioni/dati/disegni/know-how/documentazione trasmessigli da VENDITORE ovvero di cui sia venuto a conoscenza nell'esecuzione dei singoli Contratti di Vendita, indipendentemente dal fatto che tali informazioni siano o meno contrassegnate o identificate come riservate o confidenziali ("Informazioni Riservate"); (ii) non divulgare e non comunicare a terzi, né in tutto né in parte, le Informazioni Riservate senza il preventivo consenso scritto di VENDITORE; (iii) limitare l'utilizzo di tali Informazioni Riservate ed il relativo accesso per scopi relativi all'esecuzione dei singoli Contratti di Vendita; (iv) adattare tutte le misure necessarie al fine di assicurare che i propri dipendenti e i propri collaboratori evitino di divulgare a terzi le Informazioni Riservate o le utilizzino in modo improprio. Le Informazioni Riservate non potranno essere riprodotte senza previo consenso scritto di VENDITORE, e tutte le copie delle stesse saranno immediatamente restituite dietro richiesta di VENDITORE.

10.2 Le previsioni di cui sopra non si applicano alle informazioni che: (i) sono pubbliche o divengono pubbliche non per divulgazione da parte del CLIENTE, dei suoi dipendenti o collaboratori, o (ii) erano in possesso del CLIENTE prima che le ricevesse da VENDITORE o (iii) sono state divulgate da fonti che non sono sottoposte alle restrizioni cui è sottoposto CLIENTE relativamente al loro utilizzo, o (iv) possono essere divulgate a terzi in base ad un'autorizzazione scritta di VENDITORE.

## 11) Legge applicabile - Risoluzione delle controversie

11.1 Le presenti CGV e tutti i Contratti di Vendita che le parti stipuleranno in base alle presenti CGV saranno regolati dalla Convenzione di Vienna del 1980 sulla vendita internazionale di merci e, nelle materie non coperte da tale Convenzione, dalla legge italiana.

11.2 Qualsiasi controversia relativa alle presenti CGV e/o ai Contratti di Vendita che interverranno sulla base delle stesse sarà decisa in conformità alle seguenti previsioni:

a) qualora CLIENTE abbia la sua sede legale nell'Unione Europea, in Svizzera, in Norvegia o in Islanda, la controversia sarà assoggettata in via esclusiva alla giurisdizione italiana e, in relazione ad essa, sarà esclusivamente competente il Tribunale di Modena (Italia);

b) in tutti gli altri casi, la controversia sarà decisa in via esclusiva e definitiva mediante arbitrato, celebrato da un arbitro unico, in conformità al Regolamento di Procedura della Camera Arbitrale di Milano.

L'arbitrato avrà sede, e il lodo arbitrale verrà pronunciato, nella città di Milano (Italia). La lingua dell'arbitrato sarà la lingua inglese.

11.3 È tuttavia concesso, unicamente a favore di VENDITORE, il diritto incondizionato di agire, in qualità di attore, sotto la giurisdizione di CLIENTE innanzi al tribunale competente.

## 12) Lingua delle CGV

12.1 Il testo delle presenti CGV è redatto sia in lingua italiana che in lingua inglese. In caso di discrepanza, il testo in lingua italiana prevarrà sul testo in lingua inglese.

**Le presenti condizioni generali di vendita sono pubblicate e scaricabili sul sito internet [www.panariagroup.it](http://www.panariagroup.it)**

# Condizioni generali di vendita

General terms and conditions of sale\_Allgemeine Verkaufsbedingungen\_Conditions générales de vente

## 1) Scope Of Application

1.1 These General Terms and Conditions of Sale ("General Conditions") shall apply to any and all supply of ceramic tiles or other ceramic products ("Products") that will be executed to any client ("CLIENT") from any company or division of the Group Panariagroup Industrie Ceramiche S.p.A. ("SELLER"), even if these General Conditions are not expressly referred to, mentioned or expressly accepted by the CLIENT from time to time.

1.2 No provisions deviating from these General Conditions shall be binding on SELLER unless (i) included in the "Sale Contract", as defined under paragraph 3.2 below, (ii) included in documents following the Sale Contract and the content of the same has been accepted in writing by SELLER. In any case, even if deviating provisions are agreed upon, these General Conditions shall apply for the parts not expressly disregarded.

1.3 In no case shall any general conditions of contract of CLIENT be binding on SELLER, even if mentioned or included in orders or in any other documents transmitted by CLIENT to SELLER. No conduct of SELLER shall be interpreted or used in order to express tacit acceptance of SELLER to the general conditions of contract of CLIENT.

1.4 In no case SELLER shall be bound by acts and/or conducts of its agents, being the latter in lack of any power to bind SELLER.

1.5 In case CLIENT is a consumer, the provisions of these General Conditions shall not prejudice the rights of CLIENT provided for by the law applicable to sales executed toward consumers.

## 2) Products – Modifications

2.1 Any representation and/or image relating to the Products included in websites, brochures, catalogues, price lists or other similar documents of SELLER is approximate and purely illustrative. Likewise, the samples and models are to be considered as only an indication of the Products characteristics in terms of weight, size, aesthetic and technical yield and characteristics and colour and are only an approximate and/or general indication and have no binding value for the SELLER except to the extent that they are expressly mentioned as such in the written acceptance of the offer by the SELLER and do not represent the final aesthetic result of the Products. Technical and physical characteristics of the Products as well as qualities of the same are described in the technical manuals of SELLER only. Any other document including technical and physical characteristics and qualities of the Products are purely indicative and shall not bind SELLER.

2.2 SELLER declares that the Products are compliant with the applicable Italian and European industry standards. Any Products shall be used and applied in accordance with the instructions of use of SELLER included in catalogues and/or technical manuals of SELLER with reference to the Products in question or with the instructions in other way communicated and/or made available by SELLER to CLIENT and, in any case, in accordance with the diligence required by the nature of the Products. Failing to do so, CLIENT will result in the lapse of the warranty and in the unenforceability of the warranty rights under article 7 below or of any other legal or agreed warranty.

2.3 It is the responsibility of CLIENT, before executing of the Sale Contract, to make sure that the Products are suitable for their specific purpose and/or intended use and, in addition, that they also comply with the laws and regulations applicable in the place where CLIENT will import, distribute, sell or use them in any way.

2.4 SELLER may make any changes to the Products which, without altering their essential features, it deems necessary or convenient, even after execution of the Sale Contract. In case SELLER executes substantial modification to Products (e.g. modifications that will alter: the way of installation, characteristic of interchangeability of the Products, etc.) which are the object of an executed Sale Contract (as defined in paragraph 3.2 below), SELLER shall communicate in writing such modification to CLIENT.

2.5 CLIENT shall inform the purchasers of the Products and third parties of the characteristics of the Products and of the instructions of use and of application of the same in accordance with the indication provided by SELLER. Without prejudice to the above, CLIENT shall be the sole responsible and liable for the declarations it will make toward third parties with reference to the Products, their characteristics and their use or application and shall indemnify and hold SELLER harmless and from any damage possibly suffered by SELLER with reference to or in connection to such declarations of CLIENT, in case they result false, incomplete or inaccurate.

## 3) Quotations – Execution of Sale Contract – Tolerances

3.1 Written or verbal quotations issued by SELLER are not to be taken as valid contractual proposals.

3.2 The sale contract ("Sale Contract") is executed as follows:

a) an offer is sent by SELLER to CLIENT and CLIENT then sends its written acceptance of such offer to SELLER, without any modification to the offer itself; or b) a purchase order is sent by CLIENT and SELLER then sends its written acceptance of such order to CLIENT.

3.3 For the purposes of paragraph 3.2 letter a) above, the following facts or actions shall constitute the written acceptance of an offer of SELLER by CLIENT:

a) the receipt by SELLER of a letter of credit sent by CLIENT;  
b) the receipt by SELLER of all or part of the relevant purchase price;  
c) the receipt by SELLER of a purchase order of CLIENT. Should this be the case, any order of CLIENT that differs from the provisions of the offer of SELLER shall be binding on SELLER only if and to the extent that SELLER had expressly accepted it in writing.

3.4 In addition, for the purposes of paragraph 3.2 letter b) above, in case the acceptance of SELLER includes terms and condition different from those of the order of CLIENT, the Sale Contract shall be deemed to be concluded at the conditions included in the acceptance of SELLER, unless CLIENT notifies SELLER, in writing, not to accept the terms and conditions of the acceptance of SELLER within 1 (one) working day from the receipt of such acceptance.

3.5 All supplies of Products will only include what is expressly indicated in Sale Contract.

3.6 CLIENT recognizes to SELLER quantity and quality tolerances as resulting from the Sale Contract or from the usage and practices of the sector of the Products.

## 4) Packing – Delivery term – Delivery time

4.1 The Products will be packaged and readied to ship in compliance with the standard protection methods generally adopted by SELLER for the Products in question, in consideration of the agreed mode of transport.

CLIENT shall expressly request to SELLER any special packaging or supplementary protection it deems necessary, and in such event CLIENT will bear all related costs thereof.

4.2 Unless otherwise provided for in the Sale Contract, the Products shall be delivered to CLIENT in accordance with the Incoterms® ICC rule, latest version, Ex-Works (EXW) – premises of SELLER indicated in the Sale Contract.

CLIENT authorizes SELLER to undersign, in the name and on behalf of CLIENT, any and all transport documents which shall be signed at the time of collection of the Products at the premises of SELLER, such as the CMR.

In the event that the ICC Incoterms® rule agreed between the parties provides that CLIENT shall take care of the transportation of the Products outside the territory of Italy:

a) in case of an Intra-EU supply, within 45 (forty-five) days from the receipt of the Products at its premises, CLIENT shall send SELLER an original or a copy of the international transportation document CMR or of another transportation document, undersigned at destination by CLIENT or, in the absence of the international transportation document CMR, a declaration of receipt of the Products issued on the basis of the form as Annex -1- available for download at [www.panariagroup.it](http://www.panariagroup.it);

b) in case of an Extra-EU supply, CLIENT shall:

i) submit the custom export declaration (SAD-EX + EAD) and execute the validation of the MRN (Movement Reference Number) at the customs of the UE territory of exit of the Products, within 90 (ninety) days from the date of delivery of the same in Italy;

ii) send SELLER, within 90 (ninety) days from the date of delivery, documents proving the exportation of the Products (custom export declaration SAD-EX + EAD + certification of exit);

iii) notify SELLER, in writing, as soon as such submission is accomplished and provide SELLER with any other document proving the execution of such formalities as well as the exit of the Products from the UE Territory.

In case CLIENT is in breach of its obligations under this paragraph 4.2, SELLER shall be entitled to immediately charge CLIENT the amount of the Value Added Tax applicable to the supply and connected to the lack of proof of the transportation of the Products in a another Member State of the EU or to the lack of execution of custom clearance formalities. In any case, CLIENT shall indemnify and hold SELLER harmless with reference to any payment due to tax offices for fines, interests or on any other basis, in connection with the supply and with the lack of the proof of the transportation of the Products in a another Member State of the EU or with the lack of execution of custom clearance formalities.

In this respect, SELLER shall be entitled to: (i) offset any amount due by CLIENT on the basis of this paragraph 4.2 against any amount due, for whatever reason, from SELLER to CLIENT; or (ii) definitively withhold any amount received in regard to Sale Contracts, offsetting the CLIENT's debt under this paragraph 4.2 against any and all sums already paid by CLIENT.

4.3 SELLER shall deliver the Products within the delivery date provided for in the Sale Contract, in a single delivery or in partial deliveries. The delivery date shall always be considered neither of the essence nor peremptory. Except in case of wilful wrongdoing or gross negligence, SELLER will not reimburse possible damages, either direct or indirect, suffered by CLIENT as a result of delay in the delivery of the Products.

In no case of delay in the delivery of the Products shall CLIENT be entitled to terminate the Sale Contract.

4.4 Upon receipt of the Products, CLIENT must report possible damages occurred to the packaging and/or shortages or anomalies of the Products occurred during the transport, by notifying details of such events on the transportation document, and must also:

a) have such notification countersigned by the carrier; and  
b) immediately inform SELLER thereof, in writing, and send SELLER a copy of the countersigned document by and no later than 8 (eight) day(s) from the date of receipt of the Products.

Should this not be the case, SELLER shall not be responsible for possible damages losses or theft of the Products occurred during the transport, even if transport risks were, in whole or in part, upon SELLER.

## 5) Prices – Payment – Late Payment

5.1 The Products shall be supplied at the prices agreed between the parties in the Sale Contract or, should no prices be mentioned in the Sale Contract, at the prices resulting from the price list of SELLER in force when the Sale Contract has been executed. Unless otherwise stated in writing, the prices of the Products included in SELLER's price lists, quotations and/or offers are in Euro, net of VAT and for delivery according to the Incoterms® ICC rule, latest version, Ex-Works (EXW) - premises of SELLER indicated in the Sale Contract. Therefore, should a different Incoterms® rule be agreed upon between the parties for the delivery of the Products, the invoiced amount shall be modified accordingly, including in the sale invoice transportation expenses and any other costs connected with the Incoterms® rule agreed between for delivery.

5.2 CLIENT shall pay for the Products in accordance with the payments methods and terms provided for in the Sale Contract or otherwise agreed upon in writing between the parties. No payment shall be considered as being made by CLIENT until the relative amount has been credited to the bank account of SELLER.

Payment shall be executed by CLIENT in Euro or in the currency of the place where CLIENT has its registered office, at SELLER's discretion, in accordance with the currency indicated by SELLER in the related sale invoice.

5.3 If CLIENT is delinquent in its payment obligation, SELLER may:

a) obtain payment of late payment interest in accordance with the applicable law; and

b) withhold ongoing and future deliveries, upon written notice to CLIENT, until all delinquent amounts and late payment interest are fully paid.

5.4 If delinquent amounts and late payment interest remain unpaid 30 (thirty)

days after the agreed deadline for payment, then SELLER may also, at its option, alternatively or cumulatively, and in addition to any other right or remedy available at law or pursuant to these General Conditions:

a) request accelerated payment of any and all remaining payments and declare due the total outstanding balance, even if payment by instalment or deferred payment has been agreed upon and/or bills of exchange, promissory notes, cheques or other payment documents have been issued and are falling due;

b) terminate the Sale Contract in question and definitively withhold any amount received in regard to such Sale Contract or to other Sale Contracts, offsetting the CLIENT's outstanding debt against any and all sums already paid by CLIENT;

c) carry out future deliveries of Products on a pre-payment basis only, also with reference to supplies still to be executed;

d) cancel discounts and bonuses that may have been agreed between the parties also with reference to Sale Contracts already regularly executed.

5.5 SELLER shall be entitled to exercise the rights mentioned in paragraphs 5.3 and 5.4 above also in case:

a) CLIENT is undergoing winding-up, bankruptcy, debt restructuring or enforcement proceedings;

b) the insurance company of SELLER refuses insurance coverage for SELLER's credits toward CLIENT;

c) CLIENT is undergoing financial difficulties able to hinder the regular execution of its payment obligations resulting from, by way of example only, missed payment of bills of exchange, promissory notes, cheques or other payment documents, reduction of granted guarantees and/or missed granting of promised guarantees, as well as from any amount resulting unpaid, even though such circumstances have occurred with other suppliers of CLIENT.

5.6 CLIENT cannot claim any breach of contract by SELLER, nor can CLIENT start any lawsuit or action against SELLER, until any amount resulting due to SELLER under paragraphs 5.3 and 5.4 above has been paid in full by CLIENT.

## 6) Retention of Title

6.1 SELLER will maintain exclusive ownership over the Products sold until their price has been entirely paid by CLIENT.

Without prejudice to the above the risks of loss of the Products shall be regulated by the Incoterms® rule agreed between the parties for the delivery of the Products.

6.2 In case of non-fulfillment or late fulfillment of the obligation to pay the price of the Products, without prejudice to the rights under paragraphs 5.4, 5.5 and 5.6, SELLER shall be entitled to enter the premises where the Products are held, repossess the Products and withhold, as liquidated damages, any amount already paid by CLIENT with reference to such Products.

## 7) Warranty

7.1 Without prejudice to the provisions of paragraphs 2.1, 2.2, 2.4 and 3.6 with reference to the modifications to the Products and tolerances, SELLER warrants that the Products will conform to the Sale Contract, to the classification indicated in the technical manuals, catalogues and/or price lists of SELLER and that they will be free from manufacturing defects.

The warranty period is 12 (twelve) months from the date of collection of the Products from the premises of SELLER, regardless of the agreed Incoterms® rule for delivery.

7.2 The following are expressly excluded from warranty:

a) chromatic alterations and tone differences of the Products;

b) the Products identified in the Sale Contract as Products of quality lower than first-quality Products or as close-out sale Products or as special batches;

c) the Products applied and/or set up not in compliance with the industry standards applicable to the same;

d) the Products used or applied on surfaces and/or in spaces or environments different from those indicated by SELLER;

e) the Products used not in compliance with the instructions and/or indications provided by SELLER included in the catalogues and price lists of SELLER or in other way communicated to CLIENT by SELLER, included the instructions under paragraph 2.2;

f) the Products used not in compliance to the standard diligence and/or to the technics required by the nature of the Products;

g) frost resistance of the Products, unless such characteristic of the Products has been declared by SELLER in the technical manual of the Products;

h) characteristics of the Products as resulting from the classification of the pottery (i) executed by control and/or certification authorities other than authorities of the European Union Member States, and/or (ii) executed on the basis of criteria other than those used by SELLER.

7.3 Without prejudice to the provisions of paragraph 4.4 above, CLIENT shall inspect the Products as soon as possible and shall notify SELLER in writing of possible non-conformities or defects, by fax or email, within and no later than the following terms; failing to do so will result in the lapse of the warranty and the unenforceability of the warranty rights:

a) differences in type or quantity with respect to type or quantity agreed as well as other patent non-conformities or defects of the Products: 8 (eight) days from the delivery of the Products at the premises of CLIENT and, in any case, before application of the Products;

b) hidden non-conformities or defects of the Products: 8 (eight) days from the discovery of the same and, for avoidance of doubt, within the warranty period.

7.4 SELLER will have the right to examine the Products, or samples of the Products, which CLIENT claims to be non-conforming or defective, in order to verify the instructions relating to the set up and/or application of the Products and/or the use of the Products in accordance with the provisions of these General Conditions. In this respect, CLIENT shall be entitled to return to SELLER the Products that CLIENT considers to be non-conforming or defective only upon SELLER's written authorization and only on the condition that CLIENT bears all costs and risks for the shipment of the Products. The authorization to return the Products or samples of the purportedly non-conforming or defective Products shall never be interpreted as an acknowledgment of the claimed non-conformities or defects on the part of SELLER.

7.5 In case the Products are ascertained by SELLER as actually non-conforming or defective, CLIENT will be entitled only to obtain, at the SELLER's option:

a) replacement of the non-conforming or defective Products; or  
b) partial or full exemption from payment of their price, depending on the seriousness of the non-conformities or of the defects.

7.6 For the purpose of paragraph 7.5 letter (a), the Products to be delivered in replacement of non-conforming or defective Products shall be delivered to CLIENT in accordance with the Incoterms® 2010 ICC rule DDP - premises of CLIENT. The Products that have been replaced shall be, at SELLER's discretion, destroyed or disposed of by CLIENT, at its own costs, or returned to SELLER, at costs of SELLER. In case the Products are to be destroyed or disposed of by CLIENT, CLIENT undertakes to send to SELLER the proof of destruction or of disposal of the Products, along with the documents proving the costs borne by CLIENT for the destruction or the disposal of the same.

7.7 The rights and remedies described in paragraphs 7.5 and 7.6 above are the sole warranty rights and remedies granted to CLIENT. To the maximum extent permitted by the applicable law, any other liability and obligation of SELLER, which may in any way arise from or in relation to the supply of non-conforming or defective Products - including, but not limited to, compensation for direct or indirect or consequential damages, loss of profits, etc. connected to such liability - is expressly excluded.

7.8 The present warranty is in substitution for, and excludes, any other warranty, express or implied, set forth by the law or otherwise.

## 8) Force Majeure

8.1 SELLER shall not be liable or responsible for failure or delay in performing or fulfilling any obligations undertaken in reference to the supply of Products when such failure or delay is due to the occurrence of an event of force majeure such as wars, fires, earthquakes, floods, tsunamis, strikes, labor or employment difficulties, shortage or procurement difficulties of raw materials, restriction on the use of power, suspension or difficulties in the transports, breakdown of the plants, acts of public authorities or any other event or cause whatsoever, similar or dissimilar, which cannot reasonably be forecast or provided against and which cannot be overcome by SELLER with reasonable diligence.

8.2 In such event, the time for fulfillment of the obligation shall be extended for the period of continuance of such force majeure event.

In the event any of such force majeure event continue for a period longer than 6 (six) months, CLIENT shall have the right to terminate the underlying Sale Contract, by giving written notice to SELLER by registered letter with return receipt or courier, and SELLER shall not incur any responsibility or liability whatsoever.

## 9) Severability

The invalidity or unenforceability of any provision, or portion thereof, of this General Conditions shall not affect the validity or enforceability of any other provision.

## 10) Confidentiality

10.1 CLIENT undertakes: (i) to treat with the utmost confidentiality all the information/data/designs/know-how/documentation transmitted by SELLER or that it may come to know in connection with the execution of any Sale Contract, even if they are not marked or identified as secret or confidential ("Confidential Information"); (ii) not to, wholly or partially, disclose to or inform third parties of the Confidential Information, without the SELLER's prior written consent; (iii) to limit the use of the Confidential Information and the access to the same for purposes relating to the execution of the sale Contracts; (iv) to adopt any and all measures required in order for its employees and collaborators do not disclose the Confidential Information to third parties or use it in an inappropriate way.

The Confidential Information shall not be copied or reproduced in any way, unless with the prior written consent of SELLER, and all the copies of the Confidential Information shall be immediately returned to SELLER upon simple written request of the same.

10.2 The provisions above shall not apply to information which (i) are public or publicly available not due to a disclosure of CLIENT or of CLIENT's employees or collaborators; or (ii) were already available to CLIENT before it had received them by SELLER; or (iii) are disclosed from third parties that have no obligation of confidentiality or restrictions of use on the same; (iv) can be disclosed according to a written authorization of SELLER.

## 11) Applicable Law – Dispute Resolution

11.1 These General Conditions and all the Sale Contracts that will occur on the basis on the same will be governed by the United Nations Convention on Contracts for the International Sale of Goods (Vienna Convention of 1980) and, with respect to matters not covered by such Convention, by Italian laws.

11.2 Any dispute arising out of or in connection with these General Conditions or in connection with a Sale Contract occurred on the basis on the same shall be settled in accordance with the following provisions:

a) In case CLIENT has its registered office within the European Union, in Switzerland, in Norway or in Iceland, the dispute shall be subjected to the jurisdiction of the Italian courts and shall be exclusively referred for its resolution to the Court of Modena (Italy).

b) In any other case, the dispute shall be exclusively referred to and finally resolved by arbitration, by a sole arbitrator, in accordance with the Rules of the Milan Chamber of Arbitration (the Rules).

The seat of arbitration shall be, and the award shall be delivered in, Milan (Italy).

The language to be used in the arbitral proceedings shall be English.

11.3 Irrespective of the provisions above, it is hereby granted exclusively to SELLER the right to initiate legal proceedings under the jurisdiction of CLIENT before the competent court.

## 12) Language of these General Conditions

12.1 The text of these General Conditions is executed in both in Italian and in English language. In case of any discrepancy, the text in Italian shall prevail over the text in English language.

**These general terms and conditions of sale are published and downloadable on the website [www.panariagroup.it](http://www.panariagroup.it)**



Ceramics of Italy

*Seguici su / Follow us on*



Group Marketing & Communications - Panariagroup  
Gennaio 2021



**Panaria**  
ceramica

via Panaria Bassa, 22/a  
41034 Finale Emilia (Modena) - Italy  
Tel. +39 0535 95111 - Fax +39 0535 90503  
info@panaria.it - www.panaria.it

PANARIAGROUP INDUSTRIE CERAMICHE S.p.A.  
www.panariagroup.it